

The Evolution of Modern Science

Thomas L. Isenhour



Thomas L. Isenhour

The Evolution of Modern Science

The Evolution of Modern Science

1st edition

© 2013 Thomas L. Isenhour & bookboon.com

ISBN 978-87-403-0480-0

Contents

*The cover is a painting by Patricia M. Isenhour and is entitled „Surfaces“:
It is metaphorical for science and what lies ahead of us beneath the surface*

	Preface	10
	Acknowledgements	14
	To the Student	16
1	Before the Greeks (Pre-history–600 BCE)	17
2	Ancient Greek Science (600 BCE–300 CE)	21
2.1	Greek Theories	21
2.2	Greek Philosophy and Science	24
2.3	Greeks under Roman Domination	31

Free eBook on Learning & Development

By the Chief Learning Officer of McKinsey

Download Now

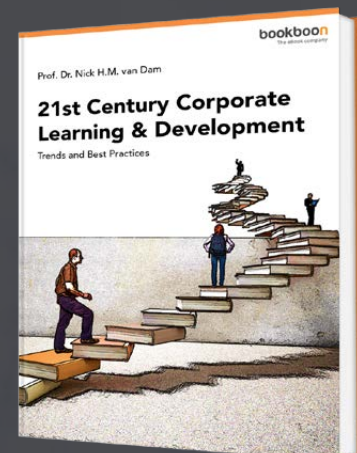

Click on the ad to read more

3	A Period of Stagnancy – The Dark Ages (300–1400)	37
3.1	The Dark Ages	37
3.2	The Scholastic Synthesis	39
4	Classical Physics and Astronomy (1400–1600)	41
4.1	A New Cosmology	41
4.2	The Language of Nature	55
5	Experimental Science and Knowledge: The Scientific Revolution and The Enlightenment (1500–1700)	58
5.1	The Scientific Revolution	58
5.2	A Mechanistic World	61
5.3	The Scientific Method	64
5.4	Space and Time	66
5.5	Newtonianism and The Scientific Revolution	75
5.6	The Enlightenment and the Idea of Progress	83
5.7	Preface to the Industrial Age	89

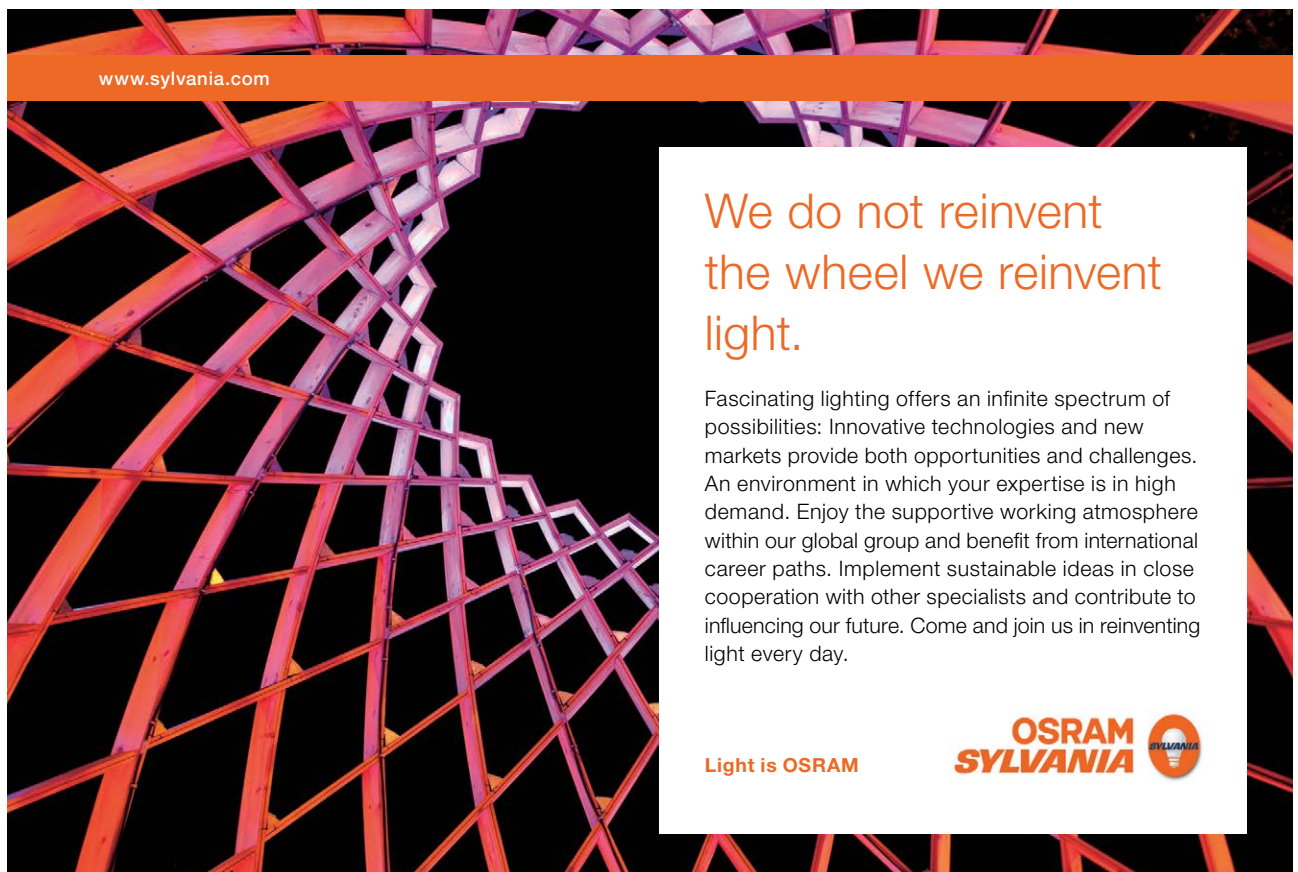

www.sylvania.com

**We do not reinvent
the wheel we reinvent
light.**

Fascinating lighting offers an infinite spectrum of possibilities: Innovative technologies and new markets provide both opportunities and challenges. An environment in which your expertise is in high demand. Enjoy the supportive working atmosphere within our global group and benefit from international career paths. Implement sustainable ideas in close cooperation with other specialists and contribute to influencing our future. Come and join us in reinventing light every day.

Light is OSRAM

**OSRAM
SYLVANIA** 

6	Classical Chemistry (1700–1900)	90
6.1	The Foundations of Modern Chemistry	90
6.2	Chemistry Becomes a Science	96
6.3	Organic (living) Chemistry	105
7	Classical Electricity, Magnetism and Light (1700–1900)	111
7.1	Electrical Phenomena	112
7.2	Volta's Cell Applied to Chemistry	116
7.3	Electricity, Magnetism and Light	117
7.4	Electrical Technology	124
8	Thermodynamics (1700–1900)	127
8.1	The Rise of Steam Technology	127
8.2	Heat and Energy – the First Law of Thermodynamics	128
8.2	Entropy – The Second Law of Thermodynamics	133
8.3	Entropy and Civilization	137
9	Natural History – Taxonomy and Geology (1700–1800)	139
9.1	Foundations of Natural History	139
9.2	Natural History and Classical Geology	146



Discover the truth at www.deloitte.ca/careers

Deloitte.

© Deloitte & Touche LLP and affiliated entities.



Click on the ad to read more

10	Classical Biology (1800–1900)	155
10.1	Evolution	155
10.2	Darwinism	164
10.3	Darwinism in America	167
11	Origin of the Social Sciences (1750–1900)	172
11.1	Economics	172
11.2	Sociology	174
11.3	Political Science	175
11.4	Psychology	177
11.5	Social Science and Statistics	178
11.6	Social Darwinism	180
12	Atomic and Nuclear Era (1900–1950)	186
12.1	Pre-1900 American Science	186
12.2	Theories of the Aether	188
12.3	X-Rays and Radioactivity	189
12.4	Atomic Structure	195
12.5	Nuclear Fusion and Fission	202

SIMPLY CLEVER

ŠKODA



We will turn your CV into
an opportunity of a lifetime

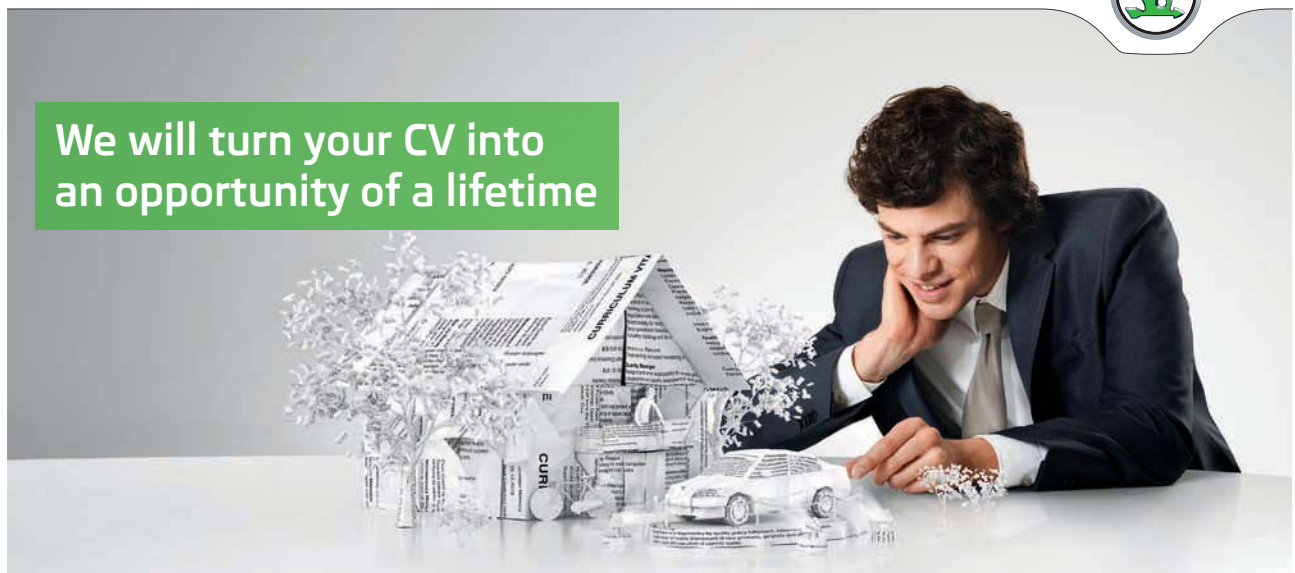

Do you like cars? Would you like to be a part of a successful brand?
We will appreciate and reward both your enthusiasm and talent.
Send us your CV. You will be surprised where it can take you.

Send us your CV on
www.employerforlife.com



Click on the ad to read more

12.6	Special Relativity	203
12.7	Quantum Mechanics	207
13	Science and the U.S. Government (1900-)	213
13.1	The Atomic Bomb	213
13.2	Sputnik and the Space Race	224
14	A New Understanding of Life (1700-)	227
14.1	The Cell	227
14.2	Genetics	233
14.3	DNA (deoxyribonucleic acid)	237
15	Modern Cosmology – the Origin of the Universe (1900-)	240
15.1	Galaxies and Cepheids	241
15.2	General Relativity and Black Holes	242
15.3	The Redshift and the Big Bang	243
16	The Chemical Bond (1900-)	247
15.4	Molecular Bonding	250



e-learning for kids

- The number 1 MOOC for Primary Education
- Free Digital Learning for Children 5-12
- 15 Million Children Reached

About e-Learning for Kids Established in 2004, e-Learning for Kids is a global nonprofit foundation dedicated to fun and free learning on the Internet for children ages 5 - 12 with courses in math, science, language arts, computers, health and environmental skills. Since 2005, more than 15 million children in over 190 countries have benefitted from eLessons provided by EFK! An all-volunteer staff consists of education and e-learning experts and business professionals from around the world committed to making difference. eLearning for Kids is actively seeking funding, volunteers, sponsors and courseware developers; get involved! For more information, please visit www.e-learningforkids.org.

17	The Computer Revolution (1900–)	257
17.1	Counting, Numbers, and Calculation	257
17.2	Mathematics and Digital Computers	260
17.3	Boolean Algebra	262
17.4	Systems of Mathematics	266
17.5	Computing Machines	266
18	The Conservation Movement and Ecology (1900–)	270
18.1	National Parks	270
18.2	Preservationists vs. Wise-Use Advocates	271
18.3	Food Chains and Ecology	273
19	Modern Geology (1900–)	276
19.1	The Age of the Earth	276
19.2	Continental Drift and Plate Tectonics	279
20	Afterword	286
21	Appendices	289
21.1	Appendix 1 – Arithmetic and Geometry	289
21.2	Appendix 2 – Formal Logic	291
21.3	Appendix 3 – Algebra	293
21.4	Appendix 4 – Analytical Geometry	297
21.5	Appendix 5 – Calculus	298
21.6	Appendix 6 – Statistics	302
21.7	Appendix 7 – Boolean Algebra and Set Theory	303
21.8	Appendix 8 – The Ancients Revisited – Titus Lucretius Carus	305
22	Bibliography	313
23	Endnotes	316

Preface

When I was a child, I would lie in the grass on a summer's evening and stare into the starry sky. All sorts of imaginations led me to wonder about the universe, about life beyond Earth, about the beginning and the end, about where we are, what we are and most of all why we are. *Why* may have been the most important word in my vocabulary because it allowed me to bombard adults with questions about everything. Because of a patient father, I got a reasonable number of answers. Most of all, I learned that it was alright to question, to wonder and to seek explanations.

Science (from the Latin *scire*, to know), seeks answers, explanations of the natural world. From the first cave person that wondered why the mountains rumbled during a storm, we have evolved a set of consistent explanations for natural phenomena. In effect, the cave dwellers were crudely practicing science when they hypothesized that the noises were made by monsters, or gods, in the mountains. The cave dwellers were practicing a crude political science when they decided to give offerings to these gods to make them benevolent. The cave dwellers were practicing religion when they decided to worship (and fear) the gods in the mountains. Perhaps religion and science began simultaneously. Unfortunately, there developed a mythology around these suppositions and, when humans became able to measure phenomena more accurately, they found the conclusions of science at odds with religion, or at least with mythology. Much of the rocky road of scientific progress has been impeded by these potholes of mythology.

The Evolution of Modern Science outlines the history of science from Aristotle to the present. (I have been asked why I chose the word *Evolution* for the title and not *Development* or something else. I will answer that at the end, but we need to cover some important ideas first.) Scientific progress has always been coupled with human progress and subject to the politics and culture of the time. Scientists, in most instances, have been in the main stream of society; however, through their curiosity and innovation they have often clashed with the prevailing culture.

Aristotle, who some say was the first scientist, was a student of Plato and integrated philosophy, science and religion. Aristotle tried to explain everything in the universe. Aristotle's cosmology was incorporated into Christianity by St. Thomas Aquinas and when Galileo disproved much of Aristotle's mechanics and cosmology, he found himself on trial for heresy.

Isaac Newton was born the year Galileo died and, at the age of 22, launched the Scientific Revolution with the invention of calculus. However it took a hundred years of advocacy by such notables as Voltaire, Thomas Jefferson, and Madame du Chatelet, to establish Newton's physics.

Wöhler disproved the vitalist theory of life by synthesizing an organic compound in 1828 and his laboratory research was seminal to the development of the great chemical industry. Darwinism, even though it is 150 years old, is still the favorite target of fundamentalists. A recent court battle in Dover, Pennsylvania, in 2005, ruled that Intelligent Design was religion, not science.¹ (Karl Marx admired Charles Darwin, believing the theory of evolution was a scientific basis for his economic theory. The admiration was not returned.)

The definitive experiment that gave birth to special and general relativity was done by Michelson and Morley in 1888, but seventeen years passed before Einstein found the correct interpretation – that time is a function of your frame of reference. In 1905 Einstein published papers that led to the development of quantum mechanics and relativity, including the famous equation that led to the discovery of nuclear energy and, inevitably, to the building of nuclear weapons.

After a brief introduction to pre-Greek science, *The Evolution of Modern Science* will begin with the ancient Greeks and Aristotle. This section will reach a pentacle with Archimedes who solved the mathematics of levers and said: “Give me a place to stand, and I shall move the Earth.”² The first third of the book will progress from the science of the ancient Greeks through the developments of the Renaissance that prepared the way for the Scientific Revolution. The second third will cover the Scientific Revolution and the Enlightenment concentrating on the 17th and 18th centuries. The final third of the book will be devoted to the 19th, 20th, and 21st centuries.

We will move in parallel through the basic disciplines of physics (including astronomy and cosmology), geology, chemistry and biology. Mathematics, as it has influenced the development of science, will be included and presented in a manner that will provide an understanding of its importance. We will briefly introduce arithmetic, Euclidean geometry, formal logic, algebra, analytical geometry, calculus, statistics, and Boolean algebra and set theory. (No special background in either science or mathematics is required, but you must gain an understanding of the essential role of mathematics to understand science.) We will focus on how science developed in the context of major historical movements.

The Scientific Revolution played a major role in the development of the social sciences. I believe one cannot understand Marx, Locke or Adams without first understanding Galileo, Newton and Darwin. Carl Sagan parallels science and democracy by stating that both are based on the principles of open debate, have mechanisms for correcting errors, and must not depend upon authorities that must be believed and obeyed.³

I have two goals for this work. The first is to show the evolution of modern science in historical context. The second is to demystify science by demonstrating that science is understandable; I believe an understanding of science is essential for a person to be educated.

We stand upon the threshold of momentous possibilities ranging from the cloning of human beings to the development of unlimited energy through fusion power. Science does not develop in a vacuum, but rather as part of the overall progress of human society. One needs to be prepared to deal with the dramatic changes that science is bringing to one's life. By knowing the tenets, methods, and history of science, you will be better able to deal with scientific advances on a day-to-day basis.

In some ways the scientist is like the main character in a Greek tragedy. I believe this is what Steven Weinberg, an American Nobel Laureate in physics, is saying in the conclusion to his remarkable book, *The First Three Minutes*. "But if there is no solace in the fruits of our research, there is some consolation in the research itself. Men and women are not content to comfort themselves with tales of gods and giants, or to confine their thoughts to the daily affairs of life; they also build telescopes and satellites and accelerators, and sit at their desks for endless hours working out the meaning of the data they gather. The effort to understand the universe is one of the very few things that lifts human life a little bit above the level of farce, and gives it some of the grace of tragedy."⁴

The Evolution of Modern Science tells a strange story, a history that is intertwined with politics and religion; one that turns on personalities and the ever curious drive to understand, to make sense of the world. And, as the world was expanded by instruments like the telescope and microscope, to make sense of the universe and life, to ask ultimate questions and seek their answers.

Science is respected and worshiped in our modern world. The man on the street uses the word *science* to mean anything that has reached a state of sophistication, predictability, and understanding. To say something is *a science*, whether it is surgery or political forecasting, is to give it the highest level of credibility. Science has given us remarkable rewards from the preservation of foods by refrigeration to the preservation of health by inoculation. The benefits of science, and its partner engineering, are so ubiquitous in this world of technology, that most cannot differentiate the three. (An interesting exercise is to ask someone to differentiate science, engineering and technology.)

Science was not always so highly regarded. Science emerged from the darkness of mysticism, alchemy, astrology, and sorcery. In fact, metaphysics was the original attempt to give rational explanations for natural phenomena and a necessary step in the development of an objective science.

There has always been and still is a fundamentalist movement to return to the days when answers were given by holy men rather than wise men. It was certainly the case before the first great era of science, that of the ancient Greeks, and for another period of a thousand years, called the dark ages.

We will start our discussion with the world as it was before the ancient Greeks. We will then spend some time on the Greeks and, after a brief discussion of science in the Golden Age of Islam, skip to the Renaissance and the stories of Copernicus, Galileo, Descartes, and Newton. From the wonderful 17th century we will move forward making continuous progress in science up to the present day. We will discover atomic theory, electricity and magnetism, heat and energy, and radioactivity, all of which will give us the ability to build devices for the greatest and worst of uses.

As a preview, here is my selection of the five most important scientists of all time: Galileo, Newton, Lavoisier, Darwin, and Einstein. (How could I have left out Faraday?) By the end of the book, I hope the reader will have their own list and, if it differs from mine, will feel free to write and tell me.

Do demons cause volcanoes, whirlpools, diseases? Does the sun go around the Earth? Would a cloned human being be identical to its twin? These, and other questions, are issues of science and through science we can find rational answers.

What is science? Science is the philosophy that the natural world can be known through human reason and that nature is rational, ordered and regular. When things seem irrational, the scientific answer is that we don't have enough data to solve the problem. Scientific studies lead to hypothesis, theory and law. Scientific (natural) law is transcendent of time and culture; independent of ethical or value systems; and cumulative and progressive.

We feel that we understand a phenomenon when we can formulate it mathematically. In many ways, science is the mathematical description of nature. Welcome to *The Evolution of Modern Science*. There is no more exciting story.

Thomas L. Isenhour
Norfolk, Virginia USA

Acknowledgements

This book is the outgrowth of more than fifteen years of teaching honors and humanities courses at the undergraduate and graduate levels in the history of science. Dr. Jack M. Holl, Emeritus Professor of History, Kansas State University, and I have been in continuous debate on many of the topics contained herein since we became neighbors in a trailer park in Ithaca, New York, in 1964. Jack was pursuing his PhD in History at Cornell and I was pursuing mine in Chemistry.

Later, when we were on the faculty together at Kansas State University, we outlined a course called, at that time, *The Foundations of Modern Science*. We wanted to show the development of science in historical and social context from ancient times to the present age. Our discussions about the correct approach wandered widely because of the diverse perspectives of a research humanist and a research scientist. On most issues we found agreement but I am not sure we will ever agree on all of them. This diversity may have added considerable spice to the meat-and-potatoes that histories of this sort tend to be.

I moved to Duquesne University and we first taught *Foundations* as an Honors Course there in the spring of 1996. Jack took leave to join me in the effort and we found the students enthusiastic about many of the topics we covered. We revised and then started teaching separate courses at our respective institutions.

I developed my course in two directions, teaching it both as a general education course and as a science entry in a Masters of Liberal Studies program. When I came to Old Dominion University in 2000, my course had evolved considerably and I presented it to the Department of History who accepted *The Evolution of Modern Science* as a junior level history course, labeled to fulfill a *technology* requirement of our general education program. I continue to teach *Evolution* every semester on campus and sometimes through our distance learning network. The popularity of the course has grown steadily. Every section quickly fills to capacity.

We started with, and I continued to use, *A History of Western Science*, by Anthony M. Alioto, 2nd Ed., Prentice Hall, Englewood Cliffs, 1983. It was my hope that Dr. Alioto, who teaches at Columbia College in Missouri, would write other editions. But he has told me he has other projects now. In addition to Alioto, I have drawn frequently on another outstanding book, *SCIENCE and the Making of the Modern World*, by John Marks, Heinemann, London, 1983. In general, I wish to reference and acknowledge the fine contributions of Alioto and Marks. There are many ideas that came from one or the other of them in this publication. I apologize if I have inadvertently overlooked referencing either of these books specifically at some important point. I have prepared my own manuscript from more than a decade of lecture notes and I worry that I may not have noted the source in every case.

Part of the impetus for writing this book is a desire to include science of the last 30 years as well as to cover other areas not emphasized in either of these two books. The socio-political context of the advancement of science continues to be relevant. For example, you can say: “*stem-cell research*,” or “*global warming*” and initiate a vigorous debate at any gathering. And, who would have thought that the latter half of the 20th century would see the re-birth of the evolution debate in the form of vigorous political attempts to define school curricula from a fundamentalist viewpoint? Science continues to advance from the launching of space telescopes to the development of string theory to cloning and magnetic resonance imaging. While I have not tried to be comprehensive, there should be some mention of cutting-edge science.

I wish to acknowledge the organizations and individuals that contributed in many ways to this project. Kansas State University, Duquesne University, and Old Dominion University supported the teaching of *The Foundations of Modern Science*, and *The Evolution of Modern Science* to hundreds of students over the last fifteen years. Old Dominion University was gracious enough to give me leave to complete this manuscript and also to let me test it in class. I want to thank the students for finding many errors and making many fine suggestions. I wish to thank Vice Provost Nancy Cooley for her support in my teaching this course through ODU’s TeleTechnet.

Most of all, I wish to acknowledge, Dr. Jack Monroe Hall, Historian, Teacher, and Scholar. His insights, advice, and creative discussions have led me down many paths that I would not have explored otherwise. And, Jack, while I know you won’t agree with all of my conclusions, you can certainly see your own arguments in many of them.

Finally, I wish to thank Patricia Marie Isenhour for listening and responding to me as I discussed many of these topics, and, for actually taking the course while pursuing her Master of Fine Arts Degree. You support me in all that I do. You decorate my life.

Thomas L. Isenhour
Norfolk, VA USA

To the Student

The facts stated in this book are not in dispute. The information on each development and about each individual is recorded numerous places. Students are urged to add to their understanding by referring to other books and articles. (A bibliography is provided for that purpose.)

The opinions and conclusions represent my interpretation of this history. Clearly, others will have differing interpretations of specific instances, but I think on major issues there will be considerable agreement.

The history of the evolution of modern science is interesting, exciting and curious. It is easy to be a Monday-morning-quarterback and denigrate intellectuals of the past for not seeing the obvious. However, the obvious often isn't obvious until someone else shows you. I urge you to be gentle on the characters of this story, to sympathize with their situations, to understand when they stray, and to marvel at their leaps of genius.

I encourage you to join me and continue to read and discover, to dig deeper and find answers and add your own insights. The hardest part of this entire project was to stop long enough to write, because it was always much more fun to keep learning.

Please note that *Links* instead of *Figures* have been given in most instances. The modern internet provides links to many helpful presentations, many of them animated, that aid in understanding scientific concepts. Unfortunately we have no control over the authors of these links removing or modifying them at any time. If some don't work, I apologize for the inconvenience. But I also urge you to use the internet to find other links that may be helpful to your understanding.

Finally, to all students and others who read this work, your comments, corrections, suggestions, and criticisms will be greatly appreciated.

Thomas L. Isenhour
Norfolk, Virginia USA

1 Before the Greeks (Pre-history–600 BCE)

Ancient civilizations practiced what we would today call *applied science and mathematics*. In Egypt, Babylonia, China, India, Phoenicia and ancient Israel discoveries in mathematics and astronomy were put to practical purposes. However, it is important to emphasize that virtually no coherent theory of science preceded the ancient Greeks, whom we will discuss in the next chapter.

Tally sticks, used for counting, have been dated to earlier than 30,000 BCE. Counting may have been the beginning of recording information. That is, counting may have begun as *accounting* and writing may have begun as counting marks on a stick or bone.

Basic arithmetic, which we learn in grade school, emphasizes addition, subtraction, multiplication and division. Subtraction is the reversal of addition. Multiplication is a series of additions and division is a series of subtractions. Thus, basic arithmetic is a variety of ways of counting.

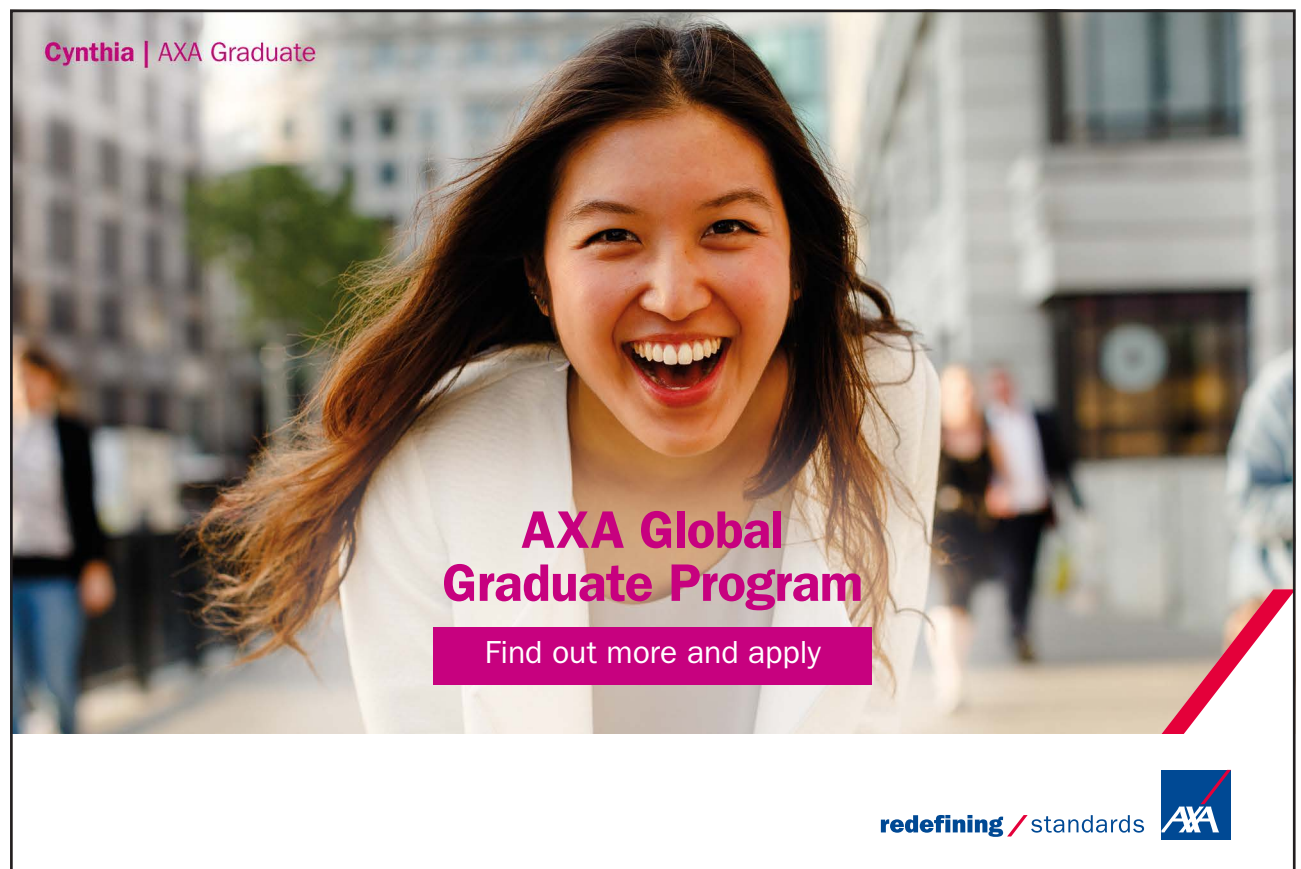

Cynthia | AXA Graduate

AXA Global Graduate Program

Find out more and apply

redefining / standards AXA

Babylonians, Egyptians, and other ancient civilizations practiced astronomy and engineering. Astronomy is useful in that it can predict the seasons and define times for planting and harvesting. With the advent of agriculture, which allowed permanent settlements (putting down roots, so to speak), geometry (Earth measure) became important for defining areas of land for ownership and commerce. With geometry one can design and construct buildings and design irrigation ditches. Geometry is the foundation of mechanical engineering.

The decimal system undoubtedly arises from the fact that we have 10 fingers. Every small child quickly learns to count to 10 by bending or touching fingers and all the cardinal numbers up to 10 are easily represented by fingers. (There were societies that used base 20 –presumably they had put their toes to work also.)

The ancient Babylonians, who were quite advanced mathematically, used base 60. It has been speculated that this might have been because a lunar month has 30 days and 30 nights. Mathematical relationships with lunar phases were important in mythology because the lunar and menstrual cycles correlate. Others argue that the base 60 system is very convenient, especially in operations like multiplication, division, and manipulating fractions, because 60 has many factors: 1, 2, 3, 4, 5, 6, 10, 12, 15, 20, and 30.

Another important lunar influence that developed is the division of a circle into 360 degrees. With 12 lunar months of 30 days each, there are approximately 360 days in a year, meaning the Earth moves (or sun moves depending on your perspective) about $1/360$ of its arc in one day.

Both solar and lunar calendars were invented but the two are hard to correlate. The Earth revolves around the sun in about 365.2425 days per year. The Julian calendar, named for Julius Caesar, had 365 days and was corrected by adding 1 day every 4 years. (These special years are called leap years.) As we will discuss later, this caused a slow, but important, shift in the dates of the beginnings of the seasons. The modern calendar (Gregorian calendar) corrects the Julian calendar by skipping the leap year every 100 years while keeping the leap year every 400 years. (Even more complicated are lunar calendars. E.g. the Jewish lunar calendar has months of 29 or 30 days and years of either 12 or 13 months. Let's leave it at that.)

Mining yields materials for weapons and tools. Moving beyond the Stone Age, flint was mined for spear and arrow heads. Later, copper and tin were mined which lead to the discovery of bronze. (Heating copper and tin together makes an alloy, bronze, that is much stronger than either of the individual metals or any other pure metal found in nature.) Finally, iron was discovered by heating iron oxide with charred wood. (The carbon in charcoal forms carbon oxides with the oxygen in iron oxide thereby *reducing* it to the metal.) Iron was much *much* stronger than any of the previous materials and could be machined, leading to the industrial age.

Because of agriculture, which was invented around 12,000 BCE and spread slowly, some botany and chemistry was discovered. Medicine developed as an art and herbal cures were often combined with incantations and other magic. Ancient surgery also developed and included such bizarre operations as trephination, opening the skull to remove brain tumors. (The skull has few nerve endings and heals well. Brain tumors often cause irrational behavior and in many instances were removed successfully and the patient recovered.) Midwifery was also an early form of medical practice.

Medical applications were usually combined with religious or magical practices and disease in general was thought to be caused by supernatural agents until the 19th century BCE, gave us modern germ theory. Egyptians became excellent at embalming but did not discover much about the way of body functions (physiology), even though they removed organs and viscera.

The Egyptians also developed advanced geometry and applied engineering as shown by the pyramids. They had a plumb bob for alignment and invented shadow clocks that evolved to sun dials.

In Mesopotamia both medicine and astrology were practiced. Some texts on diagnosis were written in an obvious educational effort. As mentioned above, Babylonian mathematics was quite advanced – they solved first and second degree equations and did other simple algebra. The Babylonians discovered extensive astronomy and geometry.

The Phoenicians wrote tables of weights and, as with other ancient civilizations, developed a calendar.

India became advanced mathematically and was one of the places where zero was discovered. Indian mathematics were recorded in sacred texts. Indian medicine was also advanced. And, there is an indication that they sought to subject nature to reason, the beginning of a scientific philosophy.

China also developed advanced mathematics, including geometry, arithmetic and some algebra. Music and astronomy were important to the Chinese and they developed mechanics and some optics. In the study of medicine, botany and chemistry played important roles.

We learn from anthropology that certain discoveries and developments happened in multiple locations, e.g. the invention of the calendar and the use of astronomy to predict seasons, times for planting and harvesting. Depending on the botany of the region, plants were found that healed certain diseases. Other natural products were discovered that were purgatives, abortives, and poisons. Mathematic relations, such as the Pythagorean Theorem were discovered repeatedly.

However, neither frameworks of reason nor functional theories to explain nature, other than religious and metaphysical ones, appear to have developed. Hence ancient science was a collection of discoveries that could be applied usefully but it was not a world-view as we think of science in the modern world. Superstition and magic played a large role in ancient science and it was not until the ancient Greeks, the subject of the next chapter, that attempts to prove mathematical relationships and explain physical phenomena occurred.

In effect, what we have been discussing was really a *pre-science*. The philosophy of the ancient Greeks will be much closer to an actual science. But, it was not until the end of the Renaissance that modern science, as we think of it, emerged. Hence, most of what we call modern science has been developed in the last 400 years.

I joined MITAS because
I wanted **real responsibility**

The Graduate Programme
for Engineers and Geoscientists
www.discovermitas.com



Month 16
I was a construction supervisor in the North Sea advising and helping foremen solve problems

Real work
International opportunities
Three work placements



2 Ancient Greek Science (600 BCE–300 CE)

2.1 Greek Theories

Civilizations long before the Greeks possessed agriculture, used engineering, practiced medicine, made calendars and discovered and used mathematics. There were Chinese, Egyptians, Babylonians and others that enhanced their cultures with science, mathematics and technology. Astronomy was among the earliest sciences developed and its use of calendars, both solar and lunar (metonic), was important for long-range planning in agriculture. Calendars were also used in religious practices as they are today.

Metallurgy and metallurgical advances divide history into great eras based upon the materials available for tools; the *Stone Age*, *Bronze Age*, and *Iron Age*. While engineering and mathematical discoveries predate recorded history, there appears to have been no earlier scientific civilization than that of the ancient Greeks. Science was sought by the Greeks, not only as a practical tool, but also as an explanation for the behavior of nature. Religion and science were integrated and, while the ancient Greeks started mankind on the path towards a scientific worldview, in no way was the Greek worldview scientific.

The predominant Greek view was that we seem to live in two worlds, a Material World and a Spirit World. The Material World includes nature, physical reality, consciousness and mind. The Spirit (Ideal) World includes ideas, spirit (God or gods), and soul.

The question (philosophical or theological) is how these worlds relate to each other. *Dualism* is the belief that both worlds exist. Most religions adopt this view and assume that the Spirit World is ultimately in charge. *Materialism* denies the existence of a Spirit World, e.g. Marxist dialectical materialism.

Science assumes there is a natural order and rational structure to nature. Science assumes there are rules and, while there may be a Spirit World (God) that has ultimate control, nature is not arbitrary but follows consistent laws. Science does not require the absence of God or spirit but does require that nature is rational in its behavior. For this reason, science can co-exist with the world-views of Dualism and Materialism. The view that there is only a spirit world excludes the possibility of science.

Around 600–500 BCE, there appeared in the Greek city states, a number of Natural Philosophers. Thales of Miletus is credited with the invention (or discovery) of philosophy around 600 BCE. Philosophy is an approach to answering ultimate questions such as existence, truth or beauty, by using reason rather than mysticism. In a sense, the very invention of philosophy foreordained the conflict between science and fundamentalism that is still occurring today.

Thales, in searching for rational explanations for nature, was joined by a number of other philosophers: e.g. Anaximander, Anaximenes, Heraclitus, Xenophanes, Parmenides, Pythagoras, Zeno, Plato, Anaxagoras, Empedocles, Democritus, Aristotle, Archimedes, and Aristarchus. We will talk briefly about several of these and their theories.

It is often said that Greek science depended solely on theory and not on experimentation. This is a simplistic view that is perhaps a bit harsh. The Ancient Greeks were not able to do the kind of experimentation that dominated the Renaissance because the technology did not exist. New materials and techniques of machining would have to come first. In reality, the Greeks depended upon observation and theory that would reconcile the observation. For example, consider the ancient notion that the Sun went around the Earth. To the casual observer, without accurate measurements recorded over time, it certainly does look like the Sun goes around the Earth, although more than one Greek thought otherwise.

Greek science sought to answer the most fundamental questions: What are matter, motion, space, and time? (An introductory physics book of today will address matter and energy while an advanced one will address space and time.) The Greeks pursued these topics in a number of ways but always with a direction of producing logical relationships, the very essence of science. The Greeks became quite advanced in mathematics and integrated their mathematics and science.

Thales of Melitus lived around 624–546 BCE. He was a merchant and carried information from one area to another. It is said that he brought geometry from Egypt where he measured the heights of pyramids from their shadows. Thales did not separate the spiritual from the material. For example, he believed that magnets had souls because they could move each other. He also believed that all things were made from water, that water was the universal substance.

Also in Melitus, and probably Thales' student, was **Anaximander** (ca 610–546 BCE). Anaximander proposed a continuous cycle of creation and destruction in the universe with the basic ingredients remaining unchanged. He proposed the first living creatures came from seeds in moisture. There was a basic ethic in Anaximander's concept of the continuously changing universe. Some consider Anaximander to be the first scientist although Aristotle holds that place in many people's minds.

Empedocles of Sicily (ca 490–430 BCE) first proposed that all things were made up of four *elements*: earth, air, fire, and water. Combinations of these elements accounted for the different properties of various substances. Today we refer to the common states of matter as solid, liquid and vapor (gas), and to less common states such as plasmas (fire).

We do not want to dwell on the Ancient Greeks and will simply give a few other basic ideas before we proceed to talk about Aristotle. Whether or not Aristotle was the first scientist he science was certainly the most comprehensive of the Ancient Greeks.

Anaxagoras (ca 500–428 BCE), from the city of Clazomenea in Asia Minor, believed that everything was made up of countless seeds, infinite and imperceptible. All things were simply combinations of these seeds and they were neither created nor destroyed. This particle idea of nature was expounded by **Democritus** (ca 460–370 BCE) of Abdera, who used the term *atoms* claiming they were the building blocks of all things.

Motion, according to Democritus, was the nature of things. Clearly the Greeks had the idea that matter was constructed of submicroscopic particles. From Anaxagoras and Democritus one can construct a totally materialistic universe. This idea is developed and used to explain many natural phenomena in Lucretius's *On the Nature of the Universe*, a lengthy summary of Greek science.

Also, one of the later Greeks, **Aristarchus** of Samos (ca 310–230 BCE) believed the Earth went around the Sun. He arrived at this conclusion by estimating the weights of the Sun, Moon, and Earth, and, because his estimate of the Sun's weight was so much greater than that of the Earth, Aristarchus concluded that the Earth was moving not the Sun. However, Aristarchus's theory was rejected because it contradicted Aristotle. We shall see how Aristotle's science takes on the mantle of authority and ultimately becomes a major stumbling block to the advancement of science.

ie business school

93%
OF MIM STUDENTS ARE
WORKING IN THEIR SECTOR 3 MONTHS
FOLLOWING GRADUATION

MASTER IN MANAGEMENT

- STUDY IN THE CENTER OF MADRID AND TAKE ADVANTAGE OF THE UNIQUE OPPORTUNITIES THAT THE CAPITAL OF SPAIN OFFERS
- PROPEL YOUR EDUCATION BY EARNING A DOUBLE DEGREE THAT BEST SUITS YOUR PROFESSIONAL GOALS
- STUDY A SEMESTER ABROAD AND BECOME A GLOBAL CITIZEN WITH THE BEYOND BORDERS EXPERIENCE

Length: 10 MONTHS
Av. Experience: 1 YEAR
Language: ENGLISH / SPANISH
Format: FULL-TIME
Intakes: SEPT / FEB

5 SPECIALIZATIONS
PERSONALIZE YOUR PROGRAM

#10 WORLDWIDE
MASTER IN MANAGEMENT
FINANCIAL TIMES

55 NATIONALITIES
IN CLASS

www.ie.edu/master-management | mim.admissions@ie.edu | [f](#) [t](#) [i](#) Follow us on IE MIM Experience

Of particular significance, **Parmenides** (born about 515 BCE) claimed that all movement was illusion. Parmenides developed an entire philosophy (perhaps a religion) built upon contradiction. His student, **Zeno** (ca 490–430 BCE) defended this viewpoint with a set of mathematical paradoxes. The essence of Zeno's approach was to break any apparent movement down to smaller and smaller pieces. For example, to walk across a room to a wall, you must first walk one-half way. But, after you walk one-half way, you must then walk one-half of the remaining way to the three-fourths point. This continues as seven-eighths, fifteen-sixteenths, etc. and Zeno concludes that it is not possible to ever reach the wall. (See Link 2.1.)

Link 2.1 Zeno's Paradox of Walking Across a Room [h
http://www.youtube.com/watch?v=MbNNFtuwA0k](http://www.youtube.com/watch?v=MbNNFtuwA0k)

In order to walk across a room, you must first go $\frac{1}{2}$ way. But once you go $\frac{1}{2}$ way, you must go $\frac{1}{2}$ of the remaining $\frac{1}{2}$ or $\frac{1}{4}$ way, which brings you $\frac{3}{4}$'s the way. Now you must go $\frac{1}{2}$ of the remaining $\frac{1}{4}$ way or $\frac{1}{8}$ way, which brings you $\frac{7}{8}$'s the way. And next you reach the $\frac{15}{16}$'s way point, and then $\frac{31}{32}$'s and $\frac{63}{64}$'s and $\frac{127}{128}$'s and $\frac{255}{256}$'s and $\frac{511}{512}$'s and on and on and on. But, you never get completely across the room!

Another of Zeno's paradoxes is a hypothetical race between Achilles and a Tortoise. Achilles, being much swifter, gives a head-start to the Tortoise. But, as Zeno points out, when Achilles runs to the point where the Tortoise starts, the Tortoise will have moved. The argument continues with Achilles never being able to catch the Tortoise. (See Link 2.2.)

Link 2.2 Zeno's Paradox of a Race between Achilles and a Tortoise
<http://www.youtube.com/watch?v=MbNNFtuwA0k>

The mathematical problem this presents is one of infinities and Greek mathematics could not deal with infinities. We will come back to Zeno when algebra becomes available, in the 9th century, and show that Zeno must be wrong. However, it will not be until the invention of calculus, in the 17th century, that Zeno's logic can be shown to not constitute a paradox.

2.2 Greek Philosophy and Science

Mathematics played a major role in the development of Greek science. **Pythagoras** of Samos (c. 570–500 BCE) formed a secret society (Pythagoreans) that sought power through mathematics. He was not the author of the Pythagorean Theorem; but rather gained recognition by using mathematical proofs to solve problems. (The Pythagorean Theorem was known by many different civilizations before the Greeks. However, the Greeks were the first to prove it mathematically. We will make the distinction between discovered mathematics and proven mathematics.)

The Pythagoreans vowed secrecy of their knowledge and took no individual credit for discoveries. They believed that whole numbers were their rulers and that anything geometric should be able to be represented by whole numbers (integers) or the ratio of two whole numbers. The Pythagoreans were noted for solving geometry and number theory problems. However, one of their members proved the existence of irrational numbers; that is numbers that cannot be represented by the ratio of two integers. This proof involved applying the Pythagorean theorem to the diagonal of a square whose two sides each have a value of 1. The value of the hypotenuse is the square root of 2 which is irrational. (Anecdotally, it is said that the individual who discovered the proof was thrown into the sea from the boat on which they were riding by other Pythagoreans because it disproved their core belief that all numbers could be represented as the ratio of two integers.) (See Link 2.3.)

Link 2.3 Square with side = 1 and diagonal = $\sqrt{2}$

For any right triangle, the Pythagorean Theorem tells us that $C^2 = A^2 + B^2$, where C is the hypotenuse (side opposite the right angle), and A and B are the two other sides. In our figure the diagonal (D) forms a right triangle with two of the sides and, since every side is equal to 1, $D = \sqrt{2}$. ($D^2 = 1^2 + 1^2$; $D^2 = 1 + 1$; $D^2 = 2$; thus $D = \sqrt{2}$.) Proof that the square root of 2 is irrational is accomplished by a method called *proof by contradiction*: In this proof, you assume there are integers R and S, such that $R/S = \sqrt{2}$. Now you square both sides to get $R^2/S^2 = 2$. From this we know that R^2 is even and hence R is even. Since R is an even number, it can be replaced by $2T$ where T is another integer. So, $2T/S = \sqrt{2}$ and $4T^2/S^2 = 2$. This last equation may be rearranged to $S^2 = 2T^2$. Now we have proven that S^2 is even and hence S is even. But, if R and S are both even numbers, they can both be divided by 2 and the whole process repeated. This goes on without limit which is absurd and means that there cannot be a pair of integers, R and S, such that their ratio is $\sqrt{2}$.

The Pythagorean Society was responsible for the discovery of important mathematics and helped set the stage for Euclid of Alexandria who was arguably the most famous Greek mathematician. Euclid lived around 300 BCE. However, Euclidean geometry was not invented or discovered by Euclid. Rather, what Euclid did was to systemize the known geometry of the time into his 13 volume *Elements of Geometry*. Euclid gives a set of definitions and postulates (axioms) and then mathematical proofs for postulates which are themselves theorems and constructions. By putting together all known geometry of the time, *Elements of Geometry* became the most important mathematical book of all time.

Euclid's *Elements* starts with 23 definitions and five postulates. The first four postulates have been accepted since Euclid's time. For example, the first postulate says that a line can be drawn between any two points. (The fifth postulate, sometimes called the parallel postulate because it states that parallel lines never meet, became a major issue in the 19th century.) Euclid goes on to provide proofs of several hundred theorems:

Starting with the Pythagoreans, the Greeks considered the circle or sphere the most perfect expression of mathematics in nature. The circle represented: Harmony, Unity, Unbroken Perfection, Infinity—no beginning, no end. The Greek belief that heavenly bodies are perfect (or ideal) and must be spherical and travel in perfect circles will cause major problems when accurate astronomical measurements begin to be made in the Renaissance.

No treatment of Ancient Greece would be complete without discussing the tremendous influence of Plato (428/427–347/348 BCE). While Plato made contributions to mathematics, he is thought of as a philosopher and not a scientist. Plato believed that we can never gain more than partial knowledge by observation. He expressed this philosophy in his allegory in the cave in which men live chained in a circle facing outward with a fire behind them. Their only knowledge is gained by the shadows they see on the cave walls. Thus, Plato believed our perceptions may be only illusions. But, by applying reason, we can gain knowledge that approaches the *ideal*. Plato believed in a system of ideas with a hierarchical structure from *divine perfection* to the *degraded* and *evil*.

Plato rejected the anthropomorphic gods of Greek mythology. God is the *ideal of good, divine perfection, perfect form, and ideal order*. God is not the creator but rather the basis of *all being*. Humans are created in the image of *absolute perfection* but from base materials. So we have a *soul* (spirit world) and *body* (material world). Through our nature we strive towards the *ideal* but are dragged back by the *material*. Nature is the basis of our reality. The ultimate in *Platonic dualism* is: *spirit is being; matter is non-being*.



"I studied English for 16 years but...
...I finally learned to speak it in just six lessons"
Jane, Chinese architect

ENGLISH OUT THERE

Click to hear me talking before and after my unique course download

Plato opened his Academy about 387 BCE. **Aristotle** (384–322 BCE) studied at the Academy for twenty years. The Academy flourished for over 900 years until the emperor Justinian closed it in 529 CE, claiming it was a pagan institution.

Unquestionably, Aristotle was the Greek who had the greatest influence on science. His world-view, which was an integrated science and religion, dominated the western world for over 2000 years.

Aristotle was born in Stagirus, a Greek colony in Thracia. Aristotle's father was court physician to the King of Macedonia. At 17 Aristotle was sent to Athens to further his education and he stayed at Plato's Academy for about 20 years leaving only after Plato died. Aristotle was brought back to Macedonia by King Philip to tutor his young son, Alexander. Aristotle tutored the future Alexander the Great for five years. After Philip's death, Alexander became king and Aristotle returned to Athens. Aristotle's philosophy was spread across the world by Alexander during his conquests.

Aristotle's intellectual interests were very broad spanning Logic, Physics, Psychology, Natural History and Philosophy. He did extensive biological classification and knew that things like whales and dolphins were not fish. He is credited with the invention of formal logic and the syllogism. Aristotle set out to describe the entire universe and, as such, was certainly the first comprehensive scientist.

Modern science, as we think of it today, did not come into existence until about 400 years ago. The science that emanated from the Ancient Greeks, through the Roman Empire and Middle Ages, was a mixture of theology and metaphysics. The celebrated clash between Galileo and the Church was caused by Galileo's disproof of Aristotle's physics.

Aristotle accepted the basic structure of Platonic Idealism. However, he disagreed with Plato's radical separation of spirit and matter, mind and body. His background was in a family of physicians and he remained interested in biology, as well as physics and astronomy, all of his life.

Aristotle's cosmology was teleological just as Plato's. There was purpose in nature. But while Plato dismissed natural objects, Aristotle believed that the Ideal could not exist apart from a material object.

Aristotle's cosmology had the Earth at the center of the universe surrounded by spheres that held the heavenly bodies, stars and planets. His universe was made up of five elements: *earth*, *water*, *air*, *fire* and *aether*. The first four elements each seek their own level. Hence, solids sink in water, air bubbles up, rain falls, and flames rise. And the fifth, *aether*, fills all the space between the heavenly bodies. The *heavens* are the eternal fixed realm, perfect in nature.

Aristotle believed that *change* arises from four causes. The *material cause* is what brought things into existence. The *formal cause* is what the thing is, as determined by its shape, pattern, essence, etc. The *efficient cause* is what makes the thing what it is. The *final cause* is the *purpose* to which it is put. Notice, *purpose* is central to Aristotle's universe.

In the case of a bronze statue, the bronze is the *material cause*, the shape of the statue the *formal cause*, the sculptor is the *efficient cause* and use of the statue to honor the warrior is the *final cause*.

According to Aristotle, everything in nature is purposeful. The change of the acorn to become an oak tree is its natural change to reach the ideal. And, the oak tree will, under certain circumstances, yield up the elements of which it is made in the form of earth (ash), water (steam), air (smoke) and fire.

Aristotle also defined three kinds of *Movement*. *Qualitative* movement is a change in the state of things. For example, people grow older, meat decays, flowers bloom. In *Quantitative* movement things increase or decrease. e.g. people gain weight; flowers lose their blooms, etc. *Change of location* is the ordinary kind of movement that we associate with animals, machines, etc.

A thing may be moved by its nature or by something else. As we said above, it is the nature of the elements to seek their natural place. Perfect movement, as exhibited by the stars, is circular. (Because of their retrograde movement, the planets presented a problem that Aristotle could not solve. We will discuss this later as we deal with astronomy.)

The paradoxes of Zeno, described earlier, were based on the idea that space was infinitely divisible, e.g. that we could move across the room by ever decreasing fractions. Aristotle rejected the notion of infinity because his universe was fixed and there would be no place for an infinite thing. Hence, Aristotle dismissed Zeno's paradoxes as nonsense.

Likewise, Aristotle dismissed the concept of zero because it represented *nothing*. Aristotle restricted his world to the finite numbers, those that lie between zero and infinity. And, since zero was meaningless, no consideration could be given to negative numbers. Likewise, Aristotle denied the idea of a vacuum, a place with nothing, because that would imply the absence of God.

According to Aristotle, the motion of a body depends upon its weight and the density of the medium through which it is moving. This is just common sense and can easily be demonstrated by dropping objects into water versus air. However, the idea that an object falls according to its weight is wrong which we shall see later.

According to Aristotle, when an object such as a spear is moving, there must be a mover. This leads to a problem for Aristotle. As long as the spear is in your hand, it is being moved by you. However, when it leaves your hand, the spear's natural movement is downward and it should fall straight to the ground, not travel in the arc as we observe. To solve this problem Aristotle assumed the spear pushed air out of the way and the air came around behind the spear and pushed it forward. Clearly you could use the same argument with a boat continuing to move through water after the rowers had stopped rowing.

Notice that when we reach the time of Newton, Newton's first law of motion will be: *A body in motion tends to continue in motion in a straight line unless acted upon by an outside force.* Aristotle would have said something like: *A body in motion tends to seek its own level unless a mover keeps acting upon it.* This is what we often observe in examples such as a ball rolling to a stop. In many ways Aristotle's physics was driven by common sense observation. But, if the ancient Greeks had been able to measure velocity accurately, they would have learned that a two pound object does not fall twice as fast as a one pound object. When we get to Galileo, we will discuss the clever way he determined that both the objects fall at the same speed.

In terms of *Cosmology*, Aristotle assumed that the Universe is spherical and full; the Universe rotates in ceaseless circular motion of the celestial spheres; above the Moon the universe is filled with aether; below the Moon it is filled with earth, water, air, and fire; and the Earth is round but does not move. That the Earth is moving seems to be disproved by throwing a rock straight up and observing that it hits the Earth directly below where it was thrown.

In the past 5 years we have drilled around

95,000 km

—that's more than **twice** around the world.

Who are we?
We are the world's leading provider of reservoir characterization, drilling, production, and processing technologies to the oil and gas industry.

Who are we looking for?
We offer countless opportunities in the following domains:

- Operations
- Research, Engineering, and Manufacturing
- Geoscience and Petrotechnical
- Commercial and Business

We're looking for high-energy, self-motivated graduates with vision and integrity to join our team.

What will you be?

careers.slb.com

Schlumberger

Aristotle believed God is the *unmoved mover*, the *prime mover*, and the *final cause*. God keeps the circular motion of the celestial spheres going.

It is important to realize that Aristotle's physics and cosmology were intertwined. To question one was to question the other.

But, the astronomy of Aristotle didn't really work. One problem was the varying brightness of the stars and planets and the changing distance of the planets. (We can see about 1000 stars and five planets without a telescope.) A much more serious problem, was the retrograde movement of the planets that could not possibly be explained with circular orbits around the Earth. (See Link 2.4.) So Aristotle simply ignored these problems the same way he ignored Zeno's paradoxes.

Link 2.4 Retrograde Motion of Planets

http://www.bisque.com/help/Patterns/image/retrograde_motion_of_mars_wmf.gif

Aristotle's cosmology is the basis for what came to be called the *Great Chain of Being*. With God as the First Cause, and the Earth as the center of the universe, a progression from God to Evil (or Heaven to Hell) is easily constructed.

A linear model for the Great Chain (or Ladder of Creation) is given here:

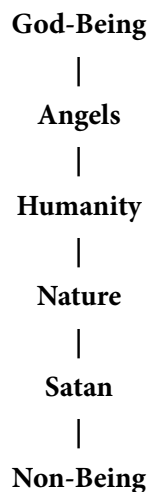

For humanity, the chain moves downward towards base things and approaches Non-Being. Climbing up the ladder one approaches, but never reaches, God-Being.

We will talk more about the Great Chain when we discuss St. Thomas Aquinas and The Scholastic Synthesis. But, it is important to realize that the concept of the Great Chain follows directly from Aristotle's cosmology.

2.3 Greeks under Roman Domination

Perhaps the greatest of the Greek science scholars was born in Syracuse on the island of Sicily. **Archimedes** (ca 290/280–212 BCE) studied mathematics in Alexandria which was then a center of intellectual activity and had one of the greatest libraries of antiquity.

Archimedes made fundamental contributions in mathematics, science, and engineering. None of his original manuscripts exist but translations into Arabic credit Archimedes with a wide range of contributions. In many ways, Archimedes pre-empted Newton in his discoveries of basic mechanics and can appropriately be called the first mathematical physicist.

Archimedes solved the law of the lever using formal logic. The result tells us that for a lever to balance, the weight on each end times the distance from the end to the fulcrum, must be equal for each side. i.e. $W_1 \times L_1 = W_2 \times L_2$ where W is the weight of objects 1 and 2 and L is the distance of each object from the balance point. Hence, if the arms of the lever are not equal, the weights (or forces) on each end differ by the inverse ratio. So, if we apply a weight of one pound on a lever arm that is two feet long, the force on the other end of a one-foot lever arm is two pounds. A mechanical advantage of 2 is gained from such a lever. (See Link 2.5.) By making a lever very long, a large force can be produced.

Link 2.5 The Law of the Lever

<http://bit.ly/1d3Mmnw>

Archimedes proved, by a very clever use of logic, the Law of the Lever. The Law of the Lever says that a lever with a weight on each end and a fulcrum between the weights will balance under the following condition: $W_1 \times L_1 = W_2 \times L_2$. Where W_1 is the weight on side 1; L_1 is the distance (length) between W_1 and the fulcrum; W_2 is the weight on side 2; and L_2 is the distance (length) between W_2 and the fulcrum. From practical experience, we know that there will be a balance point somewhere between the two weights. We also know from practical experience that the balance point will be closer to the heavier weight. With the Law of the Lever we can calculate just where the balance point has to be. And, since weight is the force of gravity on an object, we can turn this into a mechanical advantage equation. For example, if we want to lift a 100 pound object, we can do so by putting the fulcrum of a lever one foot from the object and two feet from where we apply a 50 pound weight. This means that if you weigh 150 pounds, you could lift 300 pounds with this lever. (Look at a tire jack and you will see why 100 pounds of force can lift the side of a 2000 pound car.)

Mechanical advantage applies to various mechanical devices including levers, pulleys, and gear wheels. The mechanical advantage of any of these systems can be calculated by the ratio of the lengths of movement of the two ends of the device. e.g. the lever described above had two arms one of which was twice the length of the other. The longer arm would move twice the arc of the shorter and, hence, the force on the shorter would be twice that of the longer.

In those days, ships were built on the beach and then pulled down to the water with ropes. It is said that Archimedes bet his friends that he could launch a ship by himself. He won the bet by constructing a block-and-tackle (ropes and pulleys) and towing the ship to the water.

Archimedes discovered the law of buoyancy by observing that the water rose when he sat in a tub. He realized that his weight decreased by the weight of the water he displaced and when he had raised as much water as he weighed, his own body weighed nothing in the tub. It is said that Archimedes was so excited he ran out into the street naked shouting: “Eureka.” (*Eureka* means “I have found it” in classic Greek.)

In another anecdote, the King asked Archimedes to determine whether a crown he was given was solid gold without destroying it. Archimedes weighed the crown and then determined its volume by how much water it displaced. Density is just weight divided by volume and Archimedes discovered that the density of the crown was less than that of pure gold but more than that of pure silver. Hence the crown was counterfeit and, as the story goes, the giver of the gift lost his head.

Excellent Economics and Business programmes at:



university of
 groningen



“The perfect start
 of a successful,
 international career.”

CLICK HERE
 to discover why both socially
 and academically the University
 of Groningen is one of the best
 places for a student to be

www.rug.nl/feb/education

A water pump that operates by pulling air out of a pipe can only raise water about 30 feet. (This is because the water is being pushed upward by the pressure of the air above it.) Archimedes circumvented this problem with the invention of the Archimedes screw, a hollowed log with a vein carved inside which, when rotated, propels the water. Archimedes screws are still in use today. (See Link 2.6.)

Link 2.6 Archimedes Screw

http://en.wikipedia.org/wiki/Archimedes%27_screw

Archimedes used his knowledge of engineering to build great war machines to defend Syracuse from a Roman invasion from the sea. It is said he built catapults that could throw a one ton rock a kilometer with enough accuracy to hit a ship. He also built devices that could lift a ship out of the water when it came close to the shore. Finally, it is said that he built a parabolic mirror that could focus the sun on a ship's sails and set them afire.

Not all of these inventions have been verified historically but it is clear that Archimedes used his knowledge to defend his country. The Roman capture of Syracuse took two years because of Archimedes. At one point, King Hero II is said to have been so impressed by Archimedes that he ordered everyone to believe whatever Archimedes said.

In pure mathematics, Archimedes was proudest of his solution that proved that the surface area and volume of a sphere inscribed in a cylinder were each two-thirds that of the cylinder. At his request, a figure showing this relationship was carved on his tombstone.

Archimedes found a mathematical way to calculate the value of π . Given a circle the relationship between the circumference (C) and diameter (D) is: $C = \pi \times D$. A polygram inscribed within the circle will have a perimeter smaller than C and a polygram circumscribed around the circle will have a perimeter larger than C. By calculating the two perimeters, a range is determined for C. As the number of sides of the polygram increases, the range of C becomes smaller and π can be calculated more accurately. (See Link 2.7.)

Link 2.7 Archimedes Estimation of π

<https://wiki.eee.uci.edu/index.php/3.14159265>

$C = 2r\pi = \pi D$ where C is the circumference, r is the radius and D is the diameter of a circle. Using geometric construction we can calculate the perimeter for the inscribed hexagon (P_i) and the perimeter for the circumscribed hexagon (P_c) in units of the radius. $P_i = 6.00r$ and $P_c = 6.93r$. Therefore, $6.00r < C < 6.93r$ and since $C = 2r\pi$, $3.00 < \pi < 3.46$. By using a 96-gon, Archimedes determined: $3.1409 < \pi < 3.14292$, thereby establishing 3.14 for the first three significant figures of π . (Archimedes numbers are estimates because he had to estimate the square roots involved in determining the perimeters. The local book store was not selling pocket calculators in Syracuse in 250 BCE!)

Archimedes could also determine the area within irregular shapes by drawing ever smaller triangles in the shape and adding up the areas of the triangles. This approach, much like the estimation of π , borders on calculus and solves problems like Zeno's paradoxes. Had the ancient Greeks discovered algebra, it is possible that Archimedes would have invented calculus almost 2000 years before Newton!

When the Romans conquered Syracuse a soldier killed Archimedes. The soldier did not realize who he had captured. The Roman General, Marcellus, had wanted to use Archimedes's knowledge and, finding he had been killed, had the tomb built for Archimedes with the marble monument of the sphere in the cylinder that he had requested.

Archimedes lived about 100 years after Aristotle and, of course, had the advantage of the scientific and mathematical knowledge of his time. Archimedes had the cumulative knowledge of the Pythagoreans, Euclid, and others. It is a great misfortune that the cosmology and physics of Aristotle became dominant. Clearly Archimedes's physics was much more modern and would have been a much better foundation for science. The advancement of science might have been more rapid if Archimedes, instead of Aristotle, had become the standard.

The Greek astronomer, geographer, and mathematician, **Claudius Ptolemy** lived in Roman Egypt from about 85 to 165 CE. Ptolemy set out to correct the problems of Aristotle's astronomy but wanted to maintain the principle of circular movement in the heavens. As we mentioned before, the planets were often observed to reverse their directions, something that was not possible if they were moving in circular orbits around the Earth. However, Ptolemy found that he could correct these motions by using epicycles that were themselves combinations of circles upon circles. (See Link 2.8.)

Link 2.8 Ptolemy's Epicycles

<http://www.astronomynotes.com/history/epicycle.htm>

Ptolemy used observations made by the Babylonians to extend the range of measurements over a period of 800 years. He then developed mathematical models, of the type shown in the figure above, to fit the known data. By this clever combination of mathematical tricks, *Ptolemy's Handy Tables* correctly predicted the position of stars and eclipses for the next 1000 years.

The Ptolemaic system, while complex to use, provided a successful navigation aid for the Mediterranean Sea while preserving the Aristotelian principle that the heavenly bodies only moved on circular paths. This would seem the end of this episode; however, further discoveries in the Renaissance will raise the question of geocentricity again and lead to the celebrated case of Galileo versus the Church.

Two medical giants of ancient Greece were **Hippocrates of Kos** (c. 460–370 BCE), and **Galen (Claudius Galenus)** of Pergamon (129–200 CE). Both emphasized observation and Galen especially emphasized dissection as necessary to gain medical skill and knowledge.

Galen had great dissecting skills, and left behind a copious, coherent, comprehensive, and largely accurate body of work. Galen's work had some major problems, however. First of all, because he did not have access to human bodies, most of his dissections were of Barbary apes. Secondly, while Galen's work was well described, it was not accompanied by illustrations.



American online
LIGS University
is currently enrolling in the
Interactive Online **BBA, MBA, MSc,**
DBA and PhD programs:

- ▶ enroll **by September 30th, 2014** and
- ▶ **save up to 16%** on the tuition!
- ▶ pay in 10 installments / 2 years
- ▶ Interactive **Online** education
- ▶ visit www.ligsuniversity.com to find out more!

Note: LIGS University is not accredited by any nationally recognized accrediting agency listed by the US Secretary of Education. More info [here](#).



Still, like Ptolemy's astronomy, Galen's anatomy generally worked. It was Galen's *physiology* that was faulty. Generally Galen thought the human body was composed of four humors, or independent body fluids: Blood; Phlegm; Yellow bile (urinary system); and Black bile (GI system). Disease was an imbalance in these systems.

Most critically, Galen did not understand the circulation of the blood which he thought was made in the liver and veins from nourishment *cooked* in the stomach. As first suggested by Aristotle, the lungs provided *cooling air* which was carried to the heart by the *arterial vein*. The air oozed through minute pores in the septum of the heart, mixing with and cooling the blood in the arteries. The action of the heart itself was a *push-pull* action. For those of you who may be confused about how it worked, you may be relieved to know that Galen himself was never very clear about this.

Galen dominated anatomy and physiology for 1500 years because his system mostly worked. Not until the 16th century was Galen's system challenged. Galen was so confident in his work that he wrote instructions for how to be a successful doctor and claimed all you needed was his writings.

The last Greek we will discuss is **Diophantus** of Alexandria, considered by some as the father of algebra. Not many details of his life are known. He was born between 200 and 214 CE and died between 284 and 294. He wrote a number of books called *Arithmetica* that presented solutions to algebraic equations. Diophantus advanced number theory and mathematical notation and was the first Greek to recognize fractions as numbers. Diophantine equations tended to be quadratics for which he found only positive solutions. Perhaps under the influence of Aristotle, Diophantus had no knowledge of zero or negative numbers.

Diophantus did not use general methods but solved each problem by a separate approach. Many of the methods he used go back to Babylonian mathematics. His work was lost during the Dark Ages and only Arab translations kept parts of it alive. While Diophantus did not invent algebra, he provided a foundation from which the Arab development could occur.

The rise of the Roman Empire brought an end to the remarkable advances that the Greeks were making in mathematics, science and other areas. A Roman poet, **Titus Lucretius Carus** (c. 99–55 BCE), lamenting that his Roman colleagues could no longer read Greek, translated most of Greek science in a master poem called *De Rerum Nature* or *On the Nature of Things*. Modern translations use the title *On the Nature of the Universe*. (See Appendix 8.)

Lucretius's work is both inspiring and depressing. It is inspirational in showing the remarkable insights of the Greeks and how many things they were able to explain without the benefit of laboratory experimentation. It is depressing in revealing how little progress was then made for the next 1500 years. The serious student is advised to add Lucretius to their reading list. It is a must for the well-educated.

3 A Period of Stagnancy – The Dark Ages (300–1400)

3.1 The Dark Ages

After the fall of Rome in the 5th century CE, Western civilization collapsed. Within two hundred years, only scraps and fragments of Aristotle’s work remained. For a time, Ptolemy was lost to the west, although Greek astronomy was preserved and developed during this time in the Arab world. The *Almagest*, Ptolemy’s work, is a 9th century Arab translation and literally means, the Greatest. Ptolemy was not rediscovered in the West until the 12th Century – so we have a hiatus of 700 years or so. Diophantus’s work and others were translated and used by the Arabs.

By the 12th Century, most of Aristotle (as well as Ptolemy) had been translated from Arabic into Latin and was available in the West.

While the West suffered under the dark ages, a Golden Age arose in Arabia. Unlike the Romans, the Arabs extended many of the mathematical and scientific developments of the Greeks. Algebra, alchemy, algorithm, average, almanac, aorta, and alcohol are examples of words of Arabic origin that are part of today’s scientific vocabulary.

From the 7th through 13th centuries, Islamic scholars made important contributions to agriculture, astronomy, chemistry, geography, mathematics, mechanics, medicine, optics, and measurements of all kinds. They learned paper making from the Chinese and books and libraries became very important. Arabic became an international language of scholarship.

The Qur’an (or Koran) required accurate measurement of time to determine the hours of prayer, and the days of Ramadan. And, the huge empire made navigation very important especially for determining the direction to pray to Mecca. Various Caliphs built great observatories and advanced the Astrolabe of the Greeks to determine latitude. This led to advances in cartography.

In 946, the Persian astronomer **Al-Sufi** (903–986) published his *Book of Fixed Stars* in which he described Andromeda as a “little cloud” pre-empting the idea of galaxies. In the 11th century, a Persian mathematician, Al-Biruni described the Milky Way as a collection of stars. (In the West, Galileo is usually credited with this discovery in the 17th century.) Another Persian known better in the West for his poetry than his astronomy and mathematics, **Omar Khayyam** (1048–1131), determined the length of the year to be 365.24219858156 days.⁵ (The current value determined by the Hubble telescope is 365.242190 days. Khayyam’s value is accurate to 2 parts in 100 million.) Along with other astronomical advances, eclipses were predicted accurately.

In optics, the Arabs made improved glasses and developed a theory of refraction. In the 11th century, al-Haytham published his *Book of Optics* in which he described the functioning of the human eye and described sight as “visual images entering the eye.”

In medicine, Islamic doctors developed treatments for smallpox and measles. Quarantine, another word derived from Arabic, was invented to halt the spread of contagious diseases. Surgery of the eye, ear, and throat was developed. And, as will be discussed in Chapter IX, al-Nafis of Damascus discovered the circulation of the blood in the 13th century.

Jabir (ca 721–815, called Geber in Europe) is considered to be the father of chemistry. Typical of the times he studied both chemistry and alchemy, as well as astronomy and astrology, and other scientific subjects. Jabir wrote more than 20 books on chemistry describing his discoveries and emphasizing experimentation and practical applications.

Clearly, the most important contribution to come from the Golden Age was the invention of algebra. While Greeks had worked with equations and solved specific problems, it was **al-Kwarizmi** (ca 780–850) of Baghdad that gave us a systematic algebra in his 830 publication *Arithmetic*. Al-Kwarizmi introduced the decimal system to the Western world and he advanced Ptolemy’s work.



DON'T EAT YELLOW SNOW

What will your advice be?

Some advice just states the obvious. But to give the kind of advice that's going to make a real difference to your clients you've got to listen critically, dig beneath the surface, challenge assumptions and be credible and confident enough to make suggestions right from day one. At Grant Thornton you've got to be ready to kick start a career right at the heart of business.

Sound like you? Here's our advice: visit [GrantThornton.ca/careers/students](https://www.grantthornton.ca/careers/students)

Scan here to learn more about a career with Grant Thornton.



© Grant Thornton LLP. A Canadian Member of Grant Thornton International Ltd

The Arabs contributed to geometry, trigonometry, and spherical trigonometry as well. Al-Kwarizmi was one of many scholars who worked in the famous House of Wisdom in Baghdad. The House of Wisdom (which literally means *library* in Persian) was a major center of education and scholarship in the Arab world. Important works in Greek, Indian, and Persian were translated into Arabic. The House of Wisdom was destroyed by the Mongols in 1258.

The science of the Golden Age was practical and accompanied by important inventions such as the windmill and water pumps. There were great physicians and healers. However, science was not viewed as an explanation for natural phenomena and Aristotle's philosophy, translated by the Arabs into Arabic and then into Latin, was still the accepted cosmology of the time.

3.2 The Scholastic Synthesis

Thomas Aquinas (1225–1274 CE) integrated Aristotle's ideas into Christian theology in his massive 12 volume *Summa Theologica*. Aquinas accepted Aristotle's cosmology. He starts by arguing God's existence. Aquinas asks: How do we know God? He answers: From history and nature. God is Lord of history and nature – and so Aquinas achieves an integration of Jerusalem and Athens. Aquinas five arguments for the existence of God include the argument of design which can be simply stated as if something is designed there must be a designer. This is the same argument used today by creationists.

Aquinas does not reject divine revelation as the source of Truth – God acting in and through history. But it is also possible to argue for the existence of God from reason and nature. Even God cannot allow a logical contradiction.

So, for example: as in Aristotle, *motion* requires an *unmoved first mover*. If every effect requires an efficient cause, Aquinas agrees, that *first cause* is God. This is directly in agreement with Aristotle. For the Christian church, a geocentric world-view works quite nicely. The scholastic world-view or cosmology can be summed up in a model known as the *great chain of being*. The geocentric universe is commonly viewed spherically as concentric spheres with the Earth at the center and the outermost Kingdom of God at the extremity of the globular universe. (See Link 3.1.)

Link 3.1 Dante's Paradiso

<http://www.darkstar1.co.uk/Taschenp41.jpg>

Dante lived in the late 13th and early 14th centuries. Notice how his figure progresses from the *inferno* (Hell) to *Cielo Cristallino Primo Mobile* (God).

The *Great Chain of Being* or *Ladder of Creation* (see Chapter 2) expressed the hierarchical nature of creation. From *Humanity*, the chain moved downward towards lower and base things. The lower one moves on the Great Chain, the closer one moves toward formless void – or *non-Being*. But one can never get there. We cannot perceive *non-Being*, i.e. *nothing at all*. As Parmenides noted, *nothing-at-all* has to be something.

One gets a similar result climbing up the Chain or Ladder of Creation. One can never reach or know *pure form*, or *pure actuality*, i.e. God. God becomes the *first mover* or *prime mover*, the *first cause* or *ground of being*. God transcends all individuality, both spatially and temporally. For Aquinas (as for Aristotle), God is *ultimate reality*.

The Great Chain of Being is built on four great principles:

1. Plenitude: Everything that can be, is. This is the principle of the *fullness of creation*. Creation is *complete*. God did not create an imperfect or incomplete Universe. Creation is not on-going. In its perfection, there are no holes in the creation. That means there is nothing new in creation. While there is change, there is no meaningful natural history.
2. Gradation: Follows from the principle of plenitude. If the Chain is full, then the links or steps are organized from highest to lowest in precisely graded order. All the gradation that is possible, is. There are no missing links in the chains or missing rungs on the ladder.
3. Continuity: Restates the principle of gradation. There are no missing links in the Great Chain of Being, or missing rungs on the Ladder of Life. Between God and humanity lie Angels and spirits. Between humanity and Hell lie spirits, ghosts, and devils.
4. Immutability. If Creation is full, then it follows that the links are never broken and the rungs never wear out. Stars do not fail. Species do not die. The whole of creation is full, complete, and immutable until the day of judgment. This is a beautiful and comforting world-view. Essentially – God is in His Heaven and all is well.

You will recall that the Great Chain of Being is very Aristotelian. Although there was apparent change and variation in Nature, Aristotle believed the World was structured from God to inanimate world. Beginning with plants, Aristotle envisioned a progressive chain through the plant and animal kingdoms. Humans, of course, stood at the top of the chain because of their reasoning ability.

One interpretation of the sin of Shakespeare's tragic character Macbeth is that he broke the Great Chain by killing the king! Hence, he had to be punished.

This world-view is also fundamentally ahistorical. There is no evolution, geological, biological or social. God structured the world this way at the beginning. The stage is now set for major conflict. To be against the Great Chain cosmology is to be against God.

4 Classical Physics and Astronomy (1400–1600)

4.1 A New Cosmology

Despite its success, there were problems with the geocentric (Earth-centered) cosmology. In the most general sense, astronomical observations did not squarely agree with the mathematics. And, these were simple geometric calculations about circular orbits not some mystical higher mathematics. As mentioned above, there were problems accounting for the retrograde movement of the planets, and for the varying brightness of the planets. (See Link 2.4.)

The scholastics derived their knowledge of the universe from natural philosophy, observation, and mathematics. But what seems remarkable to the modern mind is that when observation and/or mathematics clashed with the authority of natural philosophy [Aristotle], natural philosophy prevailed. We will see this emphatically in the trial of Galileo where the issue was not the correct motions of heavenly bodies but whether Galileo's scientific conclusions (right or wrong) disagreed with scripture.



.....Alcatel-Lucent 

www.alcatel-lucent.com/careers

What if you could build your future and create the future?

One generation's transformation is the next's status quo. In the near future, people may soon think it's strange that devices ever had to be "plugged in." To obtain that status, there needs to be "The Shift".



Click on the ad to read more

Greek, Indian, and Muslim scholars had proposed a heliocentric (sun centered) solar system but Western scholars continued the Aristotelian philosophy that the Earth was the center of the universe. **Nicholaus Copernicus** (1473–1543) was born in Torun, Poland. His original name was Kopernik but he later Latinized the name when he was called to Rome. Copernicus lived in Poland and worked for the bishop as a clerk, or canon. He was educated as a mathematician and lived during the Reformation when the Christian church became divided. (Martin Luther had nailed his 95 theses to the Church door in 1517. The Council of Trent, a reaction to the Protestant movement, was initiated just two years after Copernicus's death.) Copernicus was a very unlikely revolutionary; however, the result of his insistence of scientific measurement as a source of truth may well have been the starting point of the coming Scientific Revolution.

The Julian calendar (established by Julius Caesar) divided the year into exactly 365.25 days. This is slightly too long and caused Easter and other Holy Days to slowly drift forward. Likewise the equinoxes and the solstices were wrongly computed. (A solstice, sun-standing-still, occurs each summer and winter when the sun has reached its northernmost or southernmost latitude for that year. An equinox occurs each spring and fall when the sun passes over the equator causing the length of the day and night to be equal.) Holy days were very important to the Church and they needed to be computed correctly. Copernicus was invited to Rome to try to produce a more accurate calendar.

The Julian calendar has three consecutive years of 365 days each followed by a leap year (each year divisible by 4) of 366 days making the year average $365\frac{1}{4}$ or 365.25 days. The Gregorian calendar was approved by Pope Gregory in 1582 based upon Copernicus's calculations. (The Gregorian calendar makes the average year 365.2425 days. See Chapter I.) When adopted, the Gregorian calendar also dropped 10 days to bring the calendar back into synchronization with the seasons as they had been in Caesar's (or Christ's) time.

Copernicus effectively based his calendar upon actual observations. In effect, he ignored Aristotle, Ptolemy, Aquinas, the Great Chain of Being, and other authorities and decided to try to get the mathematics right based upon the experimental evidence. One of his alternatives was the heliocentric universe. In a heliocentric universe, the heavens would revolve around the Sun rather than the Earth.

One of the greatest problems that Copernicus faced was that to get the math to work the Earth had to have two movements, one around the sun and the other around its axis. This was contrary to Aristotle who said that the Earth did not move and also that a celestial body could not have two movements, as anyone could determine by looking at the Moon for several days. The same side always faces the Earth. However, a heliocentric solar system would explain the retrogressive planetary motion, and the Earth revolving on its axis once a day would explain the apparent motion of the fixed stars. The North Star, which does not move at all, would then have to be aligned with the axis around which the Earth rotates.

Copernicus ultimately published his theory and calculations in his book, *On the Revolution of the Heavenly Spheres* (1543). The book was narrative followed by extensive, and complex, mathematical computations. Ironically, Copernicus died the same year the book was published.

What kind of Revolution was the Copernican Revolution? It was certainly not overnight. Why didn't the superiority of the heliocentric model become immediately apparent once pointed out? (See Link 4.1.)

Link 4.1 Heliocentric Solar System

<http://bit.ly/13Eh7fN>

At first glance Copernicus's theory seemed simple – but once you got into his mathematics it was hardly more elegant than Ptolemy. To save the perfect spherical rotation, Copernicus also had to adopt complex models including epicycles, eccentrics, and other devices just as Ptolemy had done. (See Link 4.2.)

Link 4.2 Copernican Solar System

<http://bit.ly/13PUdN8>

The model gets even more complicated for each of the planets. To preserve circular motion, Copernicus had to include more than sixty epicycles (compared to Ptolemy's eighty). Copernicus's model was a bit simpler than Ptolemy, but still very Ptolemaic.

Also, Copernicus's system did not explain some things as well as Aristotle. Copernicus had no theory to explain the motion of heavens or the motion of the Earth. In this respect his system was significantly inferior to Ptolemy's. However, it did give him the basis for calculating a more accurate calendar.

A heliocentric cosmos raises other problems as well: 1) Where is Heaven, and where is Hell? 2) What does this imply about an Earth centered creation? 3) What does it imply about a Christ centered religion?

In the midst of the Protestant Reformation, Copernicus and his friends sensed that his book could cause trouble. Copernicus died in 1543, the same year his book was published. Tradition says that he received the first copy of the book on his deathbed. His editor inserted an introduction stating that the Earth was not really moving, and that Copernicus did not mean to argue that it was. His editor explained that the only reason for the heliocentric cosmos was that the calculations were easier. At any rate, the book was so difficult that only experts consulted it. *The Copernican Revolution*, was certainly a revolution in slow motion. It was another 39 years before Copernicus's calculations were used to define the new calendar.

One of the early followers of Copernicus was a Dominican Friar named **Giordano Bruno (1548–1600)**. Bruno, an astronomer and mathematician, believed and taught that Copernicus was right. According to Bruno the sun was just a star and there are millions of planets with intelligent beings. The Church ordered him to stop teaching these ideas and when he didn't the Inquisition lured him to Venice on the promise of a job.

In Venice, Bruno was captured and tortured for 6 years but he would not recant. According to Bruno: "Time is the father of truth, its mother is our mind." "Truth does not change, because it is believed, or not believed, by the majority of the people." And, he said to his judges: "It may be you fear more to deliver judgment upon me than I fear judgment." Bruno was burned at the stake on February 17, 1600.



Join the best at
the Maastricht University
School of Business and
Economics!

Top master's programmes

- 33rd place Financial Times worldwide ranking: MSc International Business
- 1st place: MSc International Business
- 1st place: MSc Financial Economics
- 2nd place: MSc Management of Learning
- 2nd place: MSc Economics
- 2nd place: MSc Econometrics and Operations Research
- 2nd place: MSc Global Supply Chain Management and Change

Sources: Keuzegids Master ranking 2013; Elsevier 'Beste Studies' ranking 2012; Financial Times Global Masters in Management ranking 2012

Maastricht
University is
the best specialist
university in the
Netherlands
(Elsevier)

Visit us and find out why we are the best!
Master's Open Day: 22 February 2014

www.mastersopenday.nl



Click on the ad to read more

One of the experts who was impressed by Copernicus's work was **Tycho Brahe** (1546–1601). Tycho may have been the most distinguished astronomer of his age. He was a Dane who was well funded (by modern standards) by the King of Denmark. He built many of his own instruments. (The telescope was not invented until after Tycho's death.) Tycho's observations over thirty years were so accurate that modern instruments and telescopes have largely confirmed his measurements. He did an extraordinary job of mapping the heavens.

Tycho was an obsessed observer. He was a *collector*, with a mind not unlike Carlos Linneaus who later tried to organize all of biological life.

Tycho made a number of significant observations. He saw a Super Nova, or new star, in 1572. This discovery directly challenged Aristotelian cosmology and the Great Chain. A new star leads to questions about immutability. If new stars can appear, can old ones disappear?

Five years later, in 1577, Tycho accurately measured the orbit of a comet, which indicated that it was much farther away than the Moon. This also challenged Aristotle's principle of immutability. But, Tycho could not accept Copernicus because he did not believe that the Earth moved.

Copernicus, of course, had offered no evidence that the Earth was moving. How could he? It is impossible to determine the velocity of a body without an independent reference point. If you are in an airplane, or a car, or a ship, or an elevator, you cannot tell how fast you are going without a reference point. You can detect acceleration and deceleration (the rate of change of velocity) in a closed vehicle, but you cannot determine the speed or velocity of the vehicle without a reference point.

Tycho realized you could not use the Sun as a reference point because you would get the same result whether the Sun or Earth was moving. And, it was already known that one of these was true.

Tycho realized you could use the fixed stars as a reference point for both the Sun and Earth. You can determine if the Earth is moving by measuring stellar parallax. Parallax is the apparent change in angular position of the nearby stars which should occur if they are observed from two different positions in the Earth's orbit – that is, at different times of the year. (See Link 4.3.)

Link 4.3 Stellar Parallax

<http://bit.ly/1731oWg>

Tycho tried to measure stellar parallax over a six-month period when a moving Earth would have had the greatest change in position. He could not find any angular difference. But, the reason was that he had greatly underestimated how far away the *fixed* stars really are!

Light travels 3×10^8 meters/sec or 9.46×10^{15} meters per year. One second of one minute of one degree of stellar parallax, viewed from the Earth, would amount to a distance of 3.3 light-years. Tycho could not have measured an angle anywhere nearly as small as one second of one minute of one degree. The Earth moves only about 4.1×10^9 meters from one side of the sun to the other. Therefore, there was no chance that he could have detected the motion of the Earth with his instruments. He probably concluded that if the Earth is moving, stellar parallax should be observable. Tycho may have said to himself: *Here am I, the greatest observational astronomer who has ever lived, and I can't observe it. Therefore the Earth can't be moving.*

Tycho developed his own alternative which was a combination of Ptolemy and Copernicus. The Sun and Moon revolved around the Earth that was at the center of the universe; and the planets and stars rotate in enormous epicycles around the sun.

Although Tycho's attempt at compromise would satisfy no one, he had helped shake the Aristotelian assumptions at their foundation. And, his data would be used to present the final proof that the universe was not structured around the Earth.

Late in his life, Tycho realized that he would not be able to analyze the vast amount of data he had collected. He recruited **Johannes Kepler** (1571–1630), a German mathematician, to assist him in the calculations.

Kepler attended the University of Tübingen in Germany where he became a Copernican, and not surprisingly, a mathematician. Kepler taught mathematics in Protestant schools before moving to Prague to help Brahe.

Kepler was a God intoxicated man. He believed that the *glory of the heavens* reflected the *unity and simplicity* of the *mind of god*. And as an article of faith, he believed that one could discover mathematical regularity in the Universe. In this sense, Kepler was not too different from the ancient Greeks who believed that the perfect spherical nature of the universe reflected God's purpose and design.

For example, Kepler was thrilled to think of the cosmos in term of the *trinity* of the Copernican system. The *splendid harmony* of the triune cosmos represented the three things at *rest* in the Copernican universe;

The Sun – corresponded to God the Father;

The Fixed Stars – corresponded to Christ the Son;

The Intermediate Space (Aristotle's aether) – corresponded to the Holy Ghost.

But Kepler also was affected by the Copernican spirit. Mathematics should correspond to experience and observation. Kepler hoped to prove that the mathematics of the universe proved the Glory of God. Kepler asked *What makes the planets move?* and *What holds the celestial unity together?*

According to Kepler, for both theological and physical reasons, the Sun had to play a central role in holding the universe together. But how to prove it? For Kepler mathematics should hold the answer – mathematics should be able to prove it.

Because of the spin of the Earth, a universe of perfect circles made sense from a geocentric perspective. But in a heliocentric world, there is a big problem, and that problem is the planet Mars. You could devise elliptical schemes that were close, but still irregular. Tycho wanted him to solve the problem of the Martian orbit and thus reconcile Ptolemaic and Copernican cosmology. (See Link 2.4.)

Kepler worked ten years trying to work out the math – including calculating various epicenters – based on Tycho’s careful observations. A degree of arc is divided into 60 minutes each of which is divided into 60 seconds. Therefore there are 360 degrees of arc in a circle, 21,600 minutes of arc, and 1,296,000 seconds of arc. Kepler was able to make the orbit of Mars circular within 8 minutes of arc but Tycho’s observations were accurate within 4 minutes of arc. Kepler’s calculations were close, but not close enough.

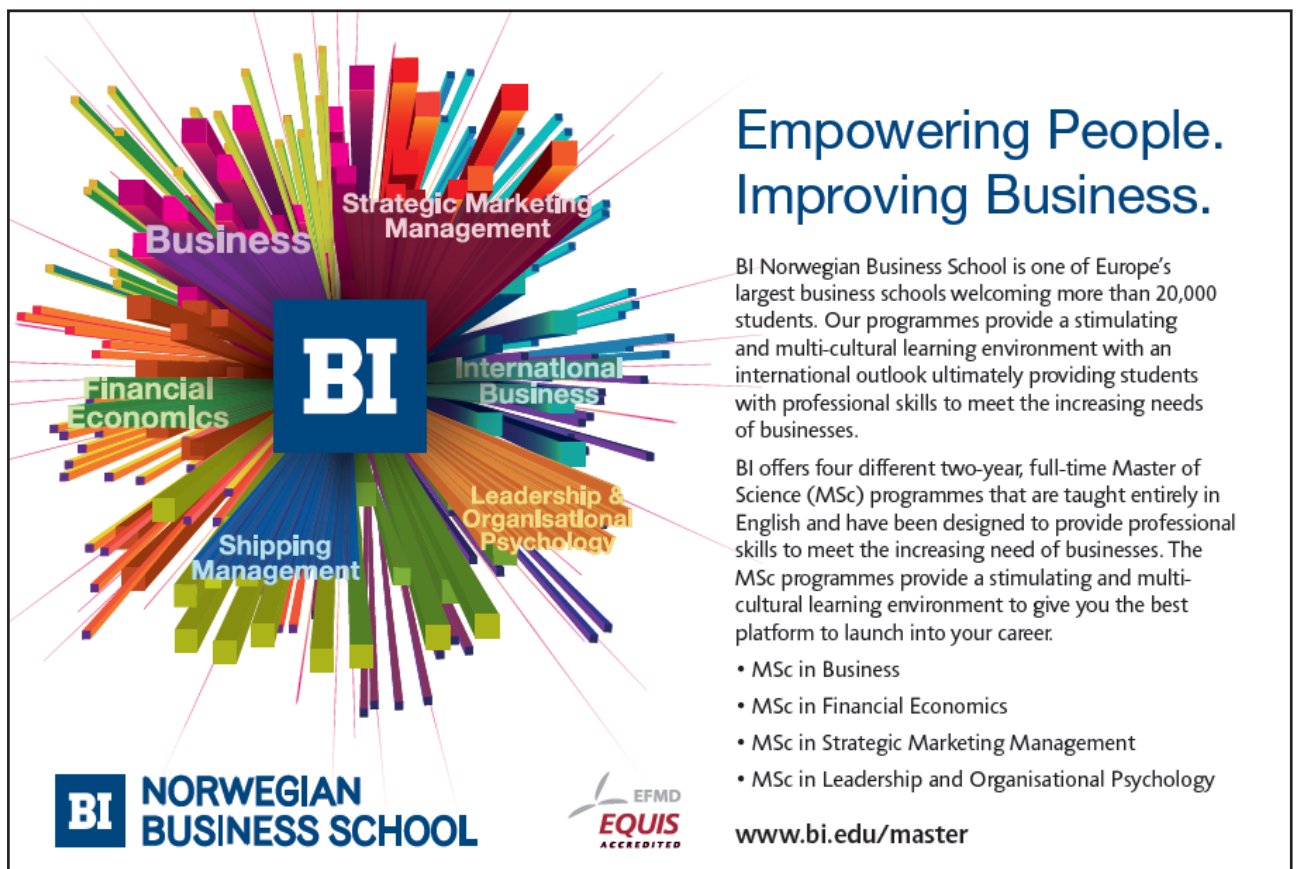

Empowering People. Improving Business.

BI Norwegian Business School is one of Europe’s largest business schools welcoming more than 20,000 students. Our programmes provide a stimulating and multi-cultural learning environment with an international outlook ultimately providing students with professional skills to meet the increasing needs of businesses.

BI offers four different two-year, full-time Master of Science (MSc) programmes that are taught entirely in English and have been designed to provide professional skills to meet the increasing need of businesses. The MSc programmes provide a stimulating and multi-cultural learning environment to give you the best platform to launch into your career.

- MSc in Business
- MSc in Financial Economics
- MSc in Strategic Marketing Management
- MSc in Leadership and Organisational Psychology

www.bi.edu/master

BI NORWEGIAN BUSINESS SCHOOL

EFMD **EQUIS** ACCREDITED

Finally he said to himself, *Let's go with the Sun*. And he gave up all attempts to find a circular motion independent from the Sun as a center. Then he got a brilliant idea. The great Archimedes had divided the circle into infinitely many triangles to find the ratio between the circumference and the diameter of the circle and π .

Presuming that Mars orbited the Sun, Kepler divided the observed orbit of Mars into triangles. Then he calculated the *time* it took Mars to pass through given segments of the arc. What he discovered was that Tycho's data were not consistent with a circular orbit, but they were consistent with an elliptical orbit. Given the choice between philosophy and observed motion, Kepler chose observed elliptical motion, even if it meant giving up the age-old Platonic assumption of perfect circles.

In addition, an elliptical movement suggested that some kind of force acted on the planets; a force that was weaker with greater distance from the Sun. Kepler's solution was ingenious. He postulated that the Sun rotated creating a vortex, a cosmic whirlpool, that carried the planets with it. (You have seen pictures of great spiral galaxies).

Then he learned about magnetism and theories of the Earth's magnetism. Kepler reasoned that if the Earth and the other planets were large magnets, then the Sun was probably a large magnet, and thus what held the universe together was the simultaneous attraction and repelling of the various magnets on each other. This was certainly ingenious and followed the theological presumption of the *magnetic soul* of the universe that was shared by all celestial bodies.

Kepler then assumed that one should be able to find mathematical harmony in the great balance of the magnets. And in searching for this harmony, he made his greatest contributions to astronomy.

Starting in 1609 Kepler published his laws of motion that he had extracted from Tycho's data. Kepler's First and Second laws dealt with the elliptical motion of the planets. It was his Third Law that we believe most excited this God intoxicated man. Using the Earth as the standard period of rotation in units of years, T , and distance from the Sun in astronomical units ($1 \text{ au} = \text{the Earth's average distance from the sun}$), D ; Kepler found that for the known planets: $T^2/D^3 = 1$ in every case. i.e. The square of the orbital time for each planet is proportional to their distance from the Sun cubed. (See Table 4.1.)

Planet	Dist. (AU)	Time (yr)	T^2/D^3
Mercury	0.39	0.24	0.971
Venus	0.72	0.62	1.030
Earth	1.00	1.00	1.000
Mars	1.52	1.88	1.001
Jupiter	5.20	11.86	1.000
Saturn	9.54	29.46	1.000
Uranus*	19.18	84.01	1.000
Neptune*	30.06	164.8	1.000
Pluto*	39.26	248.09	1.017
Eris*	67.67	557	1.001

*Discovered after Kepler's time

Table 4.1 Distances and Times of Orbit for Planets

In Kepler's time, Uranus, Neptune, Pluto, and Eris had not been discovered. They are included to show that the relationship continued to work as other planets were discovered.

Kepler believed himself to be most blessed by God. He was able to rethink God's great design and to have it revealed to him through his mathematics. This confirmed for Kepler the beautiful simplicity of the *divine mind* and strengthened his faith in the *divine order*.

Kepler had shown the mathematical harmony of the solar system but only by assuming that the Sun was at the center and controlled the motions of the planets. Thus, Mars, Jupiter, Saturn, Venus, Mercury, and Earth were all under controlled by the Sun. This was physical, scientific proof that Aristotle's cosmology was mythical and fictional. Kepler had found the mathematical unity that he sought but to do so he had to discard the Aristotelian system of cosmology.

Galileo Galilei (1564–1642 CE) was born in Pisa and initially studied for the ministry. In 1581 he started the study of medicine but found the scholastic teaching boring. He studied mathematics on his own and dropped out of formal education. He had been a difficult student, arguing with his professors at a time when dialogue was not an acceptable pedagogical technique.

In 1583 he observed the motions of pendulums, noting that the time of one swing was independent of the height from which the pendulum started the swing. By 1586, Galileo started formulating the laws of falling bodies and behaviors of bodies in water. It is not clear whether the story of his dropping weights off the Tower of Pisa is historical. But he found a very clever way to investigate the speeds of falling objects. He built inclined planes and rolled balls down them to observe their acceleration. Galileo determined that the speed of the rolling balls was proportional to the time they fell and the distance traveled was proportional to the square of the time. He tried different angles of the inclined planes and the mathematical relationships stayed the same. (See Link 4.4.)

Link 4.4 Galileo's Inclined Planes

<http://ysfine.com/maga/galtime.html>

Measuring their fall directly would have been very difficult but Galileo understood that free-fall would be equivalent to an inclined plane of 90 degrees.

Need help with your dissertation?

Get in-depth feedback & advice from experts in your topic area. Find out what you can do to improve the quality of your dissertation!

Get Help Now



Go to www.helpmyassignment.co.uk for more info



Helpmyassignment



Click on the ad to read more

Others had already challenged Aristotle's theory that the speed of falling bodies was proportional to their weight – that heavy bodies would fall faster than lighter bodies. However, Galileo found quantitative relationships between height, speed, and distance for falling objects. He not only challenged Aristotle's theory but gave a substitute that seemed to be supported by experiment!

It seems that Galileo began thinking about this problem as a consequence of watching hail storms. He noted that hailstones, large and small, randomly (or statistically if you will) hit the ground together. Galileo wrote an explanation of this phenomenon that contradicted Aristotle's theory in a small treatise *On Motion*.

Galileo's inquisitive mind would lead him in directions that clashed with the prevailing culture. He gave lectures in 1588 on the dimensions of Hell according to Dante's *Inferno* that were not appreciated by the Vatican. The Reformation was well under way and the Church was sensitive to criticism of any kind, real or implied.

In 1592, Galileo obtained a chair in mathematics at the University of Padua. He patented a water pump. Then, in 1595, he explained tidal motion in the first clear expression of his belief in the Copernican system of heliocentricity. And, in 1604 Galileo used parallax to show that supernovas are much farther than the Moon and in 1608 he proved that the path of an object traveling through space is parabolic. This was not new as Archimedes had demonstrated this mathematics and used it to aim his catapults. But it was one thing to disprove Aristotle and quite another to offer an alternative theory. (Remember that the accepted cosmology was based upon Aristotle.)

Galileo learned of the invention of the telescope in Holland in 1608 and built his own, much improved, telescope. He pointed his telescope to the stars and the results were genuinely dramatic. He made an amazing series of discoveries. The Moon had craters, mountains, and valleys. Jupiter had four Moons orbiting it in an equatorial plane. The Milky Way was composed of hundreds of unknown stars. Venus had phases just like the Moon. There were dark spots on the Sun.

In 1610, Galileo published *Sidereus Nuncius (Starry Messenger)*. This was a charming little book that was very popular, even with the Church in Rome. But unlike Copernicus and Kepler, Galileo was not reticent about popularizing his discoveries, discoveries that had enormous scientific and theological implications. He built a number of telescopes, continuing to improve them, and often gave them to important people in the hope that they would confirm his observations.

Galileo's search of the heavens virtually made untenable the Aristotelian/Ptolemaic systems. Imperfections on the Moon and beyond challenged the idea of immutability and the perfection of the heavenly bodies. All these factors further shook and rattled the belief in the Great Chain of Being.

But like his ideas of motion, again, it proved one thing to criticize Aristotle, but quite another to establish an alternative. Galileo faced many criticisms – among them were questions about whether his telescope was accurate or if he was just seeing cracks in his lens.

Galileo's greatest problem in offering Copernicus's theory as a reasonable alternative was that he could not prove Copernicus was correct. i.e. Galileo could not prove that the Earth moves.

Galileo's story can only be understood in terms of the times in which he lived. He lived during the high Renaissance when Italian art, literature, and music were at their height. Italian universities were the finest in the western world.

The hundred years before Galileo's birth was a century of magnificent discoveries. Columbus discovered the New World. Gutenberg invented the moveable type printing press. International banking was established and the world shrunk in terms of travel and communication time.

The Protestant Reformation was occurring and the Council of Trent in 1543 was convened to counter the problem. The Italian Papacy came into power. St. Peter's was completed in Rome. There were Lutherans and Calvinists in the North and Elizabethans in England. The Spanish were expanding into the New World. The Roman Index of prohibited books was established in 1559. The Church reviewed all sorts of books, but especially those on faith and morals.

By the beginning of the 17th century when Galileo ran into difficulty with the Church, the English began their settlement of North America. Indeed, Galileo's troubles and the Puritans' founding of the Massachusetts Bay Company happened concurrently. 1616 was the year that Shakespeare died, Cervantes died, Pocahontas went to London, and Galileo was called to the inquisition.

Galileo's conflict with the Catholic Church has become a symbol of the conflict between science and religion. At the end of the 19th century (in the shadow of the Darwinian controversy) Andrew Dickson White, the President of Cornell University, wrote a famous book *A History of the Warfare between Science and Theology* (1896) in which he focused on the Galileo story.

Indeed, certain facts have to be stated. Galileo was condemned by the Inquisition in 1633, was forced to renounce his theories, forbidden to publish his books, and placed under house arrest for the remainder of his life. Furthermore, the Catholic Church did not subsequently absolve Galileo until 1991.

But the conflict between Galileo and the Church was not as clear-cut as has often been claimed. It should be noted that throughout his troubles Galileo had friends and supporters in the Church. Initially, his work was well received, even in Rome. It was exciting. If you follow the chronology of the controversy, you will discover it takes curious twists and turns.

In 1616 Galileo was called to Rome to defend his theories, which he did with great eloquence. In the end, the argument went against him because he could not prove that the Earth moved. In spite of the fact that Pope Gregory XIII, in 1582, had used Copernicus's results to establish a new, and more accurate, calendar, a panel of 11 theologians, appointed by Pope Paul V, unanimously convicted Galileo of heresy for promoting the Copernican system. The two propositions for which Galileo was convicted effectively said: 1) the Sun is the center of the world and does not move; and 2), the Earth is not the center of the world and moves. The panel went on to call these ideas "foolish and absurd" in philosophy.⁶ Galileo was forbidden to defend Copernicus's theory publicly as scientific fact. The issue was not scientific truth but whether Galileo's teachings contradicted scripture!

In 1623 the Pope died, and Cardinal Barberini, who had been sympathetic to Galileo in 1616, succeeded to the throne of St. Peter. Galileo asked for and received permission to re-open his case. He was told by Cardinal Bellermino, who also admired Galileo, that he could write a balanced, impartial assessment of the Copernican controversy. Shortly, Galileo wrote in Italian a non-technical treatise – *The Dialogue Concerning the Two Chief World Systems* (Aristotelian and Copernican). The Dialogue initially passed papal censorship, was published (1632), distributed, and quickly became a best seller.

Unfortunately, Galileo ran into trouble again. *The Dialogue* was banned, and he was called to Rome to face the Inquisition for the second time. He was 68, ill, and things went from bad to worse for him.

An advertisement for SKF. It features a woman with long dark hair smiling in the foreground, with a white wind turbine in the background against a blue sky. The text is overlaid on the image.

Brain power

By 2020, wind could provide one-tenth of our planet's electricity needs. Already today, SKF's innovative know-how is crucial to running a large proportion of the world's wind turbines.

Up to 25 % of the generating costs relate to maintenance. These can be reduced dramatically thanks to our systems for on-line condition monitoring and automatic lubrication. We help make it more economical to create cleaner, cheaper energy out of thin air.

By sharing our experience, expertise, and creativity, industries can boost performance beyond expectations. Therefore we need the best employees who can meet this challenge!

The Power of Knowledge Engineering

Plug into The Power of Knowledge Engineering.
Visit us at www.skf.com/knowledge

SKF

There were two contextual issues: Galileo did have enemies, but they were mostly among scholastic school men rather than in the Church itself. Nevertheless, the scholastic school men also had powerful friends in Rome. They were fearful of Galileo because Copernicanism threatened to undermine the Aristotelian system. The Church in Rome literally felt threatened by the Protestant armies in the north of Europe. It was not a good time to be engaged in an endeavor which might undermine the authority of the Church itself.

Let's look at the treatise itself. The Pope believed that he had authorized a book that would fairly represent the arguments of both sides of the question. Instead, in *Dialogue*, Galileo wrote a highly partisan, polemical book. For example: Galileo named the Aristotelian *Simplicio*, which could have been taken in two ways: a) after *Simplicius*, the great 6th century authority on Aristotle; or as a derogatory implication that the Aristotelians were simpletons. Galileo compounded the problem by putting some of the Pope's own words into *Simplicio's* mouth. It appeared that a bitter Galileo was satirizing the very pope who sought to help him.

Galileo was a staunch Catholic and believed he was defending the Church against great embarrassment and potential disbelief. Where observation and empirical evidence disputed authority, Galileo believed that authority should give way, even if that authority were Aristotle, or the Church, or the Scriptures themselves. On this point he called upon the 4th century church father, St. Augustine. (Augustine was also a great favorite of Martin Luther, the leader of the Reformation.) Augustine, as well as others, realized that there was much in the Holy Scriptures that was poetry, illustration and metaphor that could not be taken literally.

Augustine believed that the Scriptures should be read literally except in those instances where reason and sound experience indicate otherwise. Augustine's rule was the source of some tension in determining what is reasonable and sound experience. In orthodox doctrine, the Church hierarchy, and especially the Papacy, is where this is sorted out.

But Galileo came to the belief that while God reveals himself in Scripture, He also reveals Himself in Nature. Galileo believed that God's design, purpose, order, structure, unity, and harmony of the creation is revealed in nature as well as in scripture. This is the Two Book doctrine. God reveals himself in the Book of Scriptures and the Book of Nature. Accordingly, Galileo had no intention of challenging the authority of Scripture. But he did take the position that the Scriptures was not a scientific book, nor did God intend it to be. The God of faith and morals was revealed in the Holy Scripture. The God of science and natural order was revealed in the Book of Nature. Where the Holy Scriptures conflicted with the Book of Nature, the Book of Nature should take precedence!

One can readily understand why Galileo inspired opposition in the schools and Church. Still, his ultimate condemnation appears to have hung on a problem he could not solve. Galileo could not prove that the Earth moves, thus demonstrating that Copernican theory was *scientific fact*. A commission convicted Galileo of heresy saying that his beliefs contradicted scripture. (Notice, this is not the same thing as saying his beliefs were wrong.) He was placed under house arrest for the remainder of his life. He was an old man of 68.

In some ways his defeat became a victory for Galileo. Galileo's condemnation brought increased public attention. His works were translated and published throughout Europe, even in Catholic France. So the Church's attempts to suppress his ideas backfired.

He spent his last years writing *Discourses and Mathematical Demonstrations Concerning Two New Sciences Pertaining to Mechanics and Local Motions*. Another *Dialogue*, this important book was written in Italian and smuggled to Holland for publication in 1638.

4.2 The Language of Nature

The Two New Sciences, as the book was called, was fundamentally a mathematical treatise in which Galileo set out his mature views about motion. Galileo was certainly not the first to see a relationship between mathematics and the natural world. As we have discussed, the Greeks, and especially the Pythagoreans, Euclid, and Archimedes appreciated the importance of a mathematically expressed nature. Tycho Brahe, Kepler, and others were also mathematicians who sought mathematical clarity in the natural world.

While Galileo is not unique, he came to symbolize a new world-view at the beginning of what would be called the *Scientific Revolution*. From Galileo's perspective, mathematics not only provided the best understanding of nature, but in many instances, the *only* understanding of nature. If one could not understand the language of mathematics, one could not discourse with nature.

To put it another way: God's revelation in the Book of Scriptures was written in the language of humanity. God's revelation in the Book of Nature was written in the language of mathematics. As Kepler discovered, in order to know God's thought and purpose in nature, it was necessary to learn God's natural language – mathematics.

Before Einstein, Galileo understood the principle of relativity. But we must be careful not to confuse Galileo with Einstein, whom we will discuss later. Let's call Galileo's observation *Ordinary Relativity*. The theory begins with an understanding that an object may have two motions, which are independent of one another. For example, if one throws a stone – the stone has two motions: 1. Forward or horizontal motion (which Aristotle called forced motion); and, 2. Downward motion of gravity (which Aristotle called natural motion). In Aristotle's frame of reference these motions were observed together. They would be distinguished, but not separated one from another.

Galileo understood in Ordinary Relativity that the motions are not only separate and distinct from one another, but under certain circumstances, cannot both be observed from a given position.

Example: On a moving ship, a cannon ball is dropped from a mast. If observed from the shore, the cannon ball will have two motions – a forward motion provided by the ship, and a downward motion caused by gravity. If observed from the ship, the cannon ball will have only one motion – the downward motion caused by gravity. Those on board the ship will not be able to observe the forward motion of the cannon ball because they are moving forward at the same rate. From the shore, the falling cannon ball describes a parabolic arc before hitting the deck. From the ship, the cannon ball falls in a straight line, hitting the deck in the same spot observed by those on shore. Which is the *true* event? It depends upon one's relative position of observation or *frame of reference*. (See Link 4.5.)

Link 4.5: Galilean Relativity

<http://faraday.physics.utoronto.ca/PVB/Harrison/Flash/ClassMechanics/Relativity/Relativity.html>

In thinking about the ship and cannon balls, Galileo published in the *Two New Sciences* "...a new and successful law for the free fall of bodies, the flight of projectiles, and the mathematical demonstrations he had been seeking."⁷

TURN TO THE EXPERTS FOR SUBSCRIPTION CONSULTANCY

Subscribe is one of the leading companies in Europe when it comes to innovation and business development within subscription businesses.

We innovate new subscription business models or improve existing ones. We do business reviews of existing subscription businesses and we develop acquisition and retention strategies.

Learn more at [linkedin.com/company/subscribe](https://www.linkedin.com/company/subscribe) or contact
Managing Director Morten Suhr Hansen at mha@subscribe.dk

SUBSCR✓**BE** - to the future

In experiments rolling balls down inclined planes, Galileo was able to measure their speeds and show that the velocity was a function of the time. He also showed that the weight of the rolling ball was unimportant. His conclusion was, it is not the weight or the distance traveled but the *time* that is the measure of free fall.

With the study of projectiles, we come back to the concept of two independent motions very like our two independent motions considered in our discussions of *ordinary relativity*. In the case of a cannon ball, we have *uniform* horizontal movement of the cannon ball, and *accelerating* gravitational movement of free fall. Galileo calculated the uniform horizontal motion while gravity bends the flight of the cannon ball downward until it hits the Earth.

Mathematically, what he demonstrates is that the two independent motions combine to produce a curved trajectory – a parabola. Furthermore, as later demonstrated, the ideal elevation of the cannon is 45 degrees to achieve maximum range. (It turns out that this is the same for the javelin, shot put, or a rock-throwing contest with your teenage son.)

Galileo's calculations not only demonstrate the centrality of mathematics, but also the end of Aristotelian physics based on inherent qualitative properties of nature. One should not conclude that Galileo was disrespectful of the ancient Greeks anymore than that he opposed the church or divine revelation. Indeed, he affirmed the Platonic ideal that Nature is rational, structured, and ordered. At the same time, he affirmed the Aristotelian belief that knowledge of the material world required careful observation of nature.

Where Aristotle had been *qualitative* in his analysis of nature, Galileo was *quantitative*. Of course, Galileo had the advantage of better measurement devices and more advanced mathematics.

The transition was underway to experimental science. It was a transition that did not happen quickly but was punctuated by important technological developments such as the invention of the telescope and the microscope and accurate devices for measuring temperature, pressure, and time. In addition, increased knowledge of mathematics also played a role in the development of experimental science.

5 Experimental Science and Knowledge: The Scientific Revolution and The Enlightenment (1500–1700)

5.1 The Scientific Revolution

Following are the characteristics of the Scientific Revolution. There was a belief in natural law and the purposefulness of nature; a strong rejection of authority, especially scholasticism; a commitment to observation and experimentation; a conviction that mathematics was the language of Nature; and a belief in a mechanistic cosmos. There was the establishment of international communities of scientists; The Royal Society of London (1662) and the Academie des Sciences de Paris (1666).

In addition, there occurred an information revolution in the 16th-17th century. With the improvement of printing technology, books, treatises, and pamphlets became less expensive, more plentiful, and were widely distributed. It became increasingly difficult for governments to control the dissemination of information, scientific or otherwise, as was the case in Galileo's *Two New Sciences*.

This brings us to a brief consideration of the relationship between science and technology. The importance of printing technology for the Scientific Revolution is virtually self-evident. But the relationship between science and technology is often not clear. Frequently, technology seems to develop independently of science and run well ahead of our scientific understanding of the technological processes. Example, as we shall see in the 19th century, steam technology developed well ahead of any understanding of thermodynamics. At other times, technological innovation clearly lays the foundation for scientific discovery. This was especially evident at the beginning of the Scientific Revolution in terms of the invention of certain instrumentation.

As we have already discussed, one of the most important inventions was the *telescope*. Galileo's telescopes were crude, and almost anyone who wanted one had to make their own. Even today, scientists actually spend a good deal of their time making their own instruments. It should be noted, however, that Galileo had no theory of optics to explain, or understand, how his telescope worked. That would come later. Basically, the telescope expanded an already known world. (See Link 5.1.)

Link 5.1 Galileo's Telescope

http://astronomy.wikia.com/wiki/Telescope_Construction

The *microscope* was a very different matter. It was developed in the early 17th century but, unlike the telescope, provided very poor images. Not until the 1660s were improved instruments available. The microscope became somewhat of a curiosity and toy of Royal Society – it was used to look at leaches, mold, gnats, spiders, and lice in human hair. The Italian Malpighi used the microscope to discover capillary blood vessels, thus providing the last bit of evidence to substantiate Harvey's theory of the circulation of the blood. (See Link 5.2.)

Link 5.2 Microscope

<http://inventors.about.com/od/mstartinventions/a/microscope.htm>

What do you want to do?

No matter what you want out of your future career, an employer with a broad range of operations in a load of countries will always be the ticket. Working within the Volvo Group means more than 100,000 friends and colleagues in more than 185 countries all over the world. We offer graduates great career opportunities – check out the Career section at our web site www.volvogroup.com. We look forward to getting to know you!

VOLVO
AB Volvo (publ)
www.volvogroup.com

VOLVO TRUCKS | RENAULT TRUCKS | MACK TRUCKS | VOLVO BUSES | VOLVO CONSTRUCTION EQUIPMENT | VOLVO PENTA | VOLVO AERO | VOLVO IT
VOLVO FINANCIAL SERVICES | VOLVO 3P | VOLVO POWERTRAIN | VOLVO PARTS | VOLVO TECHNOLOGY | VOLVO LOGISTICS | BUSINESS AREA ASIA

In comparison to the telescope, which expanded a familiar universe, the microscope opened up whole new worlds of existence never before contemplated. While the telescope expanded the upper limits of the Great Chain of Being, the microscope revealed unexpected realms of animate and inanimate being which did not fit obviously or easily into the Great Chain. Having never experienced the microscopic world, it was difficult to begin to comprehend it.

For example, a Dutchman, **Antony van Leeuwenhoek** (1632–1723), proved skilled in making microscopes. From a pail of lake water, he discovered scores of *animalcules*, a thousand times smaller than creatures he had discovered on cheese, mould, and flour. In his own saliva, he reported: “I now saw very plainly that these were little eels or worms, lying all huddled up together and wriggling; just as if you saw, with the naked eye, a whole tubful of very little eels a-squirring among one another;...”⁸ In his semen, he discovered similar creatures, very active and alive.

He had discovered protozoa, bacteria, and sperm. But it would not be until the 19th century that Leeuwenhoek’s discoveries would lead to major advances in biology and medicine. The reasons for this were multiple and quite revealing about the history of science:

1. Leeuwenhoek was not a scientist, but was an amateur and artisan, who published no books or papers, and was not associated with a university or scientific society. So he was outside the scientific community.
2. His research, if we can call it that, was not in the mainstream of the scientific agenda of his day. In fact, he was not in a *stream* of research at all. The scientific societies knew of his work, but considered it a curiosity at best.
3. No one else was as skillful and clever as he was in making microscopes, and no one surpassed him in the skill or acuity of his observations. Those who tried repeatedly failed in replicating Leeuwenhoek’s experiments. His microscopes were so good (magnified 300× with resolution to 1 millionth of a meter), no one else succeeded in making such a powerful instrument until the 19th century.
4. Most importantly, he was not very good at drawing, or reporting, what he saw. People simply did not have a frame of reference from experience to understand the world that Leeuwenhoek tried to describe. This is a lesson in discovering something truly new. The importance of the work can go unrecognized because others do not have mental reference points.

Leeuwenhoek’s great discoveries would ultimately be recognized, but not in his lifetime, although his discoveries may have inspired Swift in his 18th century satire on Gulliver’s Travels.

In the 1630s, an Italian, Torricelli, first working with water columns and then working with mercury, determined that the height of the mercury is always the same, regardless of the size or cross-section of the tube that contained it. Then he discovered slight day-to-day differences in the height of his mercury column. This led him to the theory that the weight of the air (or air pressure) affected the height of the mercury column. This was confirmed in a famous experiment by the French mathematician Pascal who carried a mercury column to a mountain top, leaving an identical instrument at the foot of the mountain. As anticipated, the column of mercury in the barometer became shorter as he climbed the mountain and the *barometer* was born. (See Link 5.3.)

Link 5.3 Barometer

<http://www.usatoday.com/weather/wbaromtr.htm>

Air pump experiments with the barometer raised questions about what happened in the space above the mercury or water in the weather glass. Aristotle denied the possibility of empty space or vacuum. So what happened to the air in the enclosed glass? Experiments were conducted in Germany in the 1650s with an air pump and two separate hollow hemispheres which could be put together and taken apart easily by hand when they were filled with air. But when evacuated by the air pump, sixteen teams of horses could not pull them apart. (Note: a tornado does not *suck* the roof from a building. Simply by lowering the pressure on the roof, the roof is thrown into the sky by the pressure of the air trapped in the building.)

This led to a number of vacuum experiments by Robert Boyle, distinguished member of the Royal Society, on flames, birds, mice, and the transmission of sound.

The Pendulum Clock was invented by Dutchman Christian Huygens in the 1660s. Before this, there was no accurate way to measure short time intervals. Galileo had worked out the mathematics of the pendulum earlier. To be able to measure with the precision of the pendulum was itself almost miraculous. (See Link 5.4.)

Link 5.4 Pendulum Clock

<http://www.britannica.com/clockworks/pendulum.html>

Other instruments developed during this time included the thermometer, slide rule, and other calculating devices that made possible quantitative observation and measurement rather than simple description.

5.2 A Mechanistic World

In the 17th century, scientific giants dominated the age. **Rene Descartes** (1596–1650) is best remembered for his contributions to mathematics, but in the 17th century he was one of Europe's leading scientists and philosophers. He was the leading spokesman for French Rationalism, and is often called the founder of modern philosophy.

Descartes came from a well-to-do noble family from central France. Educated by Jesuits, with whom he broke in later years, he was especially gifted in mathematics. As an adult, he had to seek refuge in Holland, which tolerated his unorthodox beliefs. With many others, he shared the belief that it was pointless to argue with the church about the science in the Bible, or about the structure of the universe. Descartes wanted to obtain independence for both science and philosophy from theology.

You will recall that Galileo, Kepler, and other mathematicians still worked rather clumsily with Euclidean geometry. Descartes' greatest contribution to mathematics was the invention of *analytical geometry*. It is said that one day Descartes contemplated a fly buzzing around a colleague's study. It occurred to him that the position of the fly in space was always a point that could be intersected by three lines which amount to the coordinates for the fly's position in the room. In other words, you could plot the flight of the fly on a graph

The importance of Descartes' development of analytical geometry for the history of science cannot be overemphasized. Analytical geometry allows all forms of motion to be analyzed mathematically, or theoretically. For example, a trajectory can be plotted on a graph with y as the vertical and x as the horizontal. The equations for the curve of any trajectory can be plotted and manipulated mathematically by assuming a change in charge and weight of the projectile, or in attitude of the cannon. With Descartes' analytical geometry, one can test a new cannon on paper, with a high degree of accuracy, before actually firing the cannon in outside field tests.



gaiteye
Challenge the way we run

EXPERIENCE THE POWER OF FULL ENGAGEMENT...

.....

**RUN FASTER.
RUN LONGER..
RUN EASIER...**

**READ MORE & PRE-ORDER TODAY
WWW.GAITEYE.COM**

As Descartes realized, one can envision an infinite number of points in space, with an infinite number of lines running through those points. The *relationship* between and among these points or coordinates can all be expressed by an *equation*. Thus any geometric figure [or problem] can be studied algebraically.

Descartes became the founder of *Systematic Rationalism* – and his major contribution in rational philosophy is that he began with himself, rather than God. His *Discourse on Method* (1637) introduced the so-called Cartesian method.

Descartes asked the question, what can we know reliably in this world of sense experience? God? The Material World? Rigorously, Descartes rejected both. We begin with doubting. And what we can't doubt is that we are doubting. Consequently, we affirm that we exist. And Descartes summed this up with *Cogito Ergo Sum*, I think therefore I am.

Descartes deduced the existence of God from his own perception of God. Either he created himself, or he was created. If he had created himself, he would have bestowed upon himself infinite perfection. But since he wasn't perfect, and since he had the idea of infinite perfection, that could not have come from his parents or another finite cause. Descartes viewed God as eternal, infinite, immutable, omniscient, omnipotent, and the Creator of all things *which are outside himself*.

Descartes stated that: 1. The material world is completely filled – there is no void. 2. A material body in the material world has extension – it can be located at point. But the point always occupies a space, a coordinate. 3. The coordinate can be expressed in two dimensions by two axes. A third axis gives three dimensions and a solid shape. One can add an infinite number of axes. Therefore, all material existence can be expressed mathematically.

Change in the coordinate, or Cartesian, system is *Motion*. And as we have already established by plotting the parabolic curve of a projectile in motion, all motion can be expressed mathematically. Motion is the transference or transportation of bodies or parts of bodies in their relation to one another. This motion is essential to the material world – which is filled. God, of course, is the Prime Mover. (But that does not mean that God is actively pushing people around like a child playing with toy figures).

Descartes's Laws of motion

1. (law of inertia) – Everything remains in motion unless otherwise altered by outside cause.
2. (law of motion) – Bodies tend to move in a straight line. If circular, bodies tend to move away from the center.
3. A body coming into contact with a larger body, loses nothing of its movement, but moves off in a different direction. But if it meets one less strong, it loses as much motion as it imparts to the other body.

Like Aristotle, Descartes could not envision action or force across space. All space is filled with matter which is constantly in motion. Action across space is the result of tiny particles or corpuscles of matter pushing or banging against one another. (There is really no action across empty space).

Descartes posits a strictly mechanical explanation of nature and the universe. In common with the Greek Democritus and other atomists, Descartes leaves no room for an imminent God.

Descartes's cosmology follows from his views of Earthly physics. The whole material universe is filled with particles or corpuscles of matter in constant motion. Around the Sun, and other Stars, there whirl great vortices of matter that carry the planets and the heavenly bodies. The whole motion of the Universe is seen in terms of the interaction of gigantic whirling vortices. *Other than playing the prime mover, God has no role in this cold, mechanical world.*

This was deductive logic. Descartes claimed to have deduced the mechanical structure of the universe from the mechanical principles of machines. He noted in *Principia Philosophiae*: “I have been greatly helped by considering machines. The only difference I can see between machines and natural objects is that the workings of machines are mostly carried out by apparatus large enough to be readily perceptible by the senses...whereas natural processes almost always depend on parts so small that they utterly elude our sense...”⁹

5.3 The Scientific Method

Francis Bacon (1561–1626) lived almost contemporaneously with William Shakespeare. He became the English champion of inductive science. Bacon was not entirely a modern man. He lived on the boundary of the medieval and modern age. He clung to the geocentric cosmology. He believed in astrology and the portent of dreams. And apparently he was not a very nice man, nor was he highly regarded by his contemporaries. He was present in the court of Queen Elizabeth I, served a long term in Parliament, and became Lord Chancellor of England under James II. But like a lot of high placed officials with intellectual pretensions, Bacon was not highly regarded as a great philosopher by his contemporaries.

But Bacon was thoroughly modern in his belief that *knowledge is utility*. The purpose of acquiring knowledge is not to learn about the nature of God and God's purposes, but to: improve human life; achieve happiness; and mitigate human suffering. In this sense, Bacon can be regarded as a *humanist*.

It followed that the goal of scientific investigation was not to achieve perfect contemplation of the Ideal, or Form, or Unity, Truth, or Perfection – but to gain *control of nature*. Bacon thought this was attainable. His book, *The New Atlantis*, is perhaps the first scientific utopia.

There has been a great deal of debate about Bacon's contribution to the Scientific Revolution. His discussions of method outlined in the *Novum Organum* (1620) are not particularly original. Descartes and Newton, among many others, were also much concerned about method at this time.

Bacon was not a scientist. He was a politician, a raconteur. He is important because he represents a habit of mind which became identified with English Empiricism in contrast to French Rationalism.

In common with the French, his secular view of sciences helped lay the foundation for the Age of Reason and the following Scientific Revolution. In contrast to Descartes' deductive logic, Bacon emphasizes the inductive method, which ideally begins with observation and experimentation. This became *the English Way*. Ideally, hypotheses and theories are derived solely from observation and experimentation. The scientist, as John Locke might suggest, approaches the subject *Tabula Rosa*, with a blank mind.

Of course, this was ideal. In practice, it is impossible to approach any scientific problem without some prior ideas. To the extent that they believed they were radical empiricists, the English no doubt were deceiving themselves; just as the French who believed that they always reached their scientific conclusions through deductive logic were also self-deceiving.



This e-book
is made with
SetaPDF

SETASIGN

PDF components for PHP developers

www.setasign.com



In fact, the interplay between inductive and deductive science was dramatically illustrated by the most famous scientist of the age, Sir Isaac Newton. And as we shall see, both inductive and deductive logic could lead to a mechanistic universe – the hallmark of the Scientific Revolution.

However, we identify the modern scientific method more with Francis Bacon than any other individual.

5.4 Space and Time

Isaac Newton (1642–1727 CE) was born on Christmas Day at Woolsthorpe. He was premature, posthumous, and the only child of an illiterate farmer of Lincolnshire, England. Not much is known of his childhood. He was a solitary child, largely raised by his grandmother. (Interestingly, Newton was born the year that Galileo died.)

He was a curious, but dreamy child who built sundials, water clocks, windmills, and kites. It is said he cleverly used a tail-wind to help him out jump other boys. His mother took him out of school to learn farming, but he had little interest in agriculture. Finally, an uncle arranged for him to attend a school to prepare to attend Cambridge University. He entered Trinity College, Cambridge in 1661 at 18, a little older than most students, and probably not as well prepared.

1660 was the end of the Glorious Revolution that had begun in 1649 with the beheading of Charles I. Charles II was restored to the throne after eleven years under the Puritan Commonwealth of Oliver Cromwell. This was a time of great upheaval and troubles in England, including at the universities.

When Newton arrived at Trinity College, the curriculum was still dominated by scholasticism and had not changed much since the 14th century. The core curriculum was still based on Latin or Greek texts of Aristotle and the various medieval and Renaissance commentators. In addition to Aristotle, young Newton studied rhetoric, mathematics, theology, and morals – the traditional liberal arts.

The intellectual climate at Cambridge after the Restoration was pretty dismal. Professors, like the Church hierarchy, frequently held their positions from patronage. Masters (the real teachers) disdained the curriculum. Disdain led to neglect, apathy, laxity, and low standards. In turn, this meant that Cambridge students largely were left to fend for themselves.

Although Cambridge was intellectually absolutely dismal, it turned out to be ideal for a student like Isaac Newton, who, left to himself, had a grand time pursuing his own intellectual inclinations. He studied mainly math (geometry), but also the new mechanical philosophy of Descartes and others. His student notebooks indicate that he became a *corpuscularian*, meaning that he accepted that all matter was comprised of *corpuscles* or particles which were not infinitely divisible. Thus he became an *atomist* of sorts, as well as a mechanist.

There were positive influences at Cambridge, however. Although the Commonwealth was gone, Puritan values continued to dominate Cambridge and influenced young Newton. Puritan values preached the stewardship of Creation; believed the study of creation (including observation and experimentation) promoted the Glory of God; affirmed interest in nature as *the second book of God's Revelation*; promoted educational reform; and, emphasized public service and hard work

In sum, Newton was heir to the new astronomy of Copernicus and Galileo, the empiricism of Bacon, the mechanistic philosophy and mathematics of Descartes, and the morality of English Puritanism.

Newton graduated in January 1665, but by June he was forced to return to Woolsthorpe by an outbreak of the bubonic plague, an epidemic known as the Black Death, which had first ravished Eastern Europe in 1348–1349. Cambridge University was closed for almost two years until the spring of 1667. During this terrible time it seemed like God's wrath was being visited on the English. In London alone 100,000 out of 450,000 died.

Newton, age 23–24, enjoyed a brief but incredible outburst of intellectual creativity known as his *Annus Mirabilis* (wonder year). During these 18 months, he: 1. Invented both differential and integral calculus, which he called his *fluxions*; 2. Discovered that white light was composed of the colored rays of the spectrum; and, 3. Found the mathematical law of gravity as it applied to the motion of the moon and bodies on the Earth.

Also remarkable, Newton published nothing about these discoveries at the time. (How different from Galileo who would have shouted his discoveries from the housetops.) Instead, after the plague he returned to his studies in Cambridge where he was accepted as one of the Masters of Trinity College. While self-effacing, his work obviously attracted attention. In 1669, when his professor Isaac Barrow resigned, Newton, just 26, succeeded him as Lucasian Professor of Mathematics. (Stephen Hawking was the Lucasian Professor from 1979 to 2009.)

Before we begin our discussion of Newton's science, I should note that while he had an enormous capacity for work and little need for sleep, as Lucasian Professor at Cambridge Newton did not spend most of his time and energy on math and science – at least math and science as we understand it. Instead, he devoted much more of his time to alchemy, church history, theology, prophecy, and ancient history and philosophy.

Unfortunately, we know little about Newton's extensive work in *non-scientific* fields. When Newton died without leaving a will in 1727, his papers and possessions passed to his niece and later her descendants. A few of his papers were published, but most were considered *not fit to be printed* and packed into boxes. Two hundred years later the family finally offered Newton's papers to Cambridge University, who appointed a committee of distinguished scholars (all of them scientists) to review the collection. The science committee screened the Newton papers and selected manuscripts in mathematics and natural sciences, which today comprise the Portsmouth Collection at Cambridge. The remaining, by far the bulk of the collection, were returned to the family and sold at public auction in 1936. The auction scattered the Newton papers around the world. Some papers ended up in the hands of private collectors, but most went to research libraries, and are available for study. Only recently has our modern, and more accurate, portrait of Newton emerged. After we consider his contributions to the history of science, we will return to Newton's larger vision for the Unity of Knowledge.

Free eBook on Learning & Development

By the Chief Learning Officer of McKinsey

Download Now

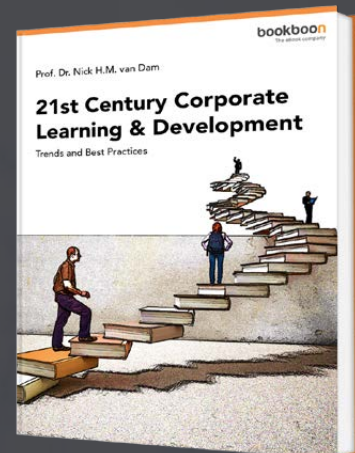

From his papers, we know that Newton began his serious study of mathematics in 1664 during his last year at Cambridge. At a Cambridge fair, he purchased a book on astrology (or perhaps astronomy) which he could not understand because he did not know trigonometry. So he bought a book on trigonometry, which he could not understand because he had never studied Euclid's *Elements*. So he next purchased Euclid and began what was largely a self-education in mathematics. (Remember, however, he did study with Isaac Barrow). After he mastered Euclid, Newton read modern mathematicians, including Kepler and Descartes. His work on *fluxional calculus* began in the fall of 1664, and continued at Woolstrophe in the spring of 1665.

Newton's fluxions, which became known as calculus, solved the problem of infinities. For example, when we drive 50 miles in one hour we know we averaged a speed of 50 mph. But, we also know that we drove faster some of the time and slower some of the time. We can get the average speed by calculating the difference in position (Δy) and difference in time (Δt) and solving for $\Delta y/\Delta t$. So if we drove 100 miles in 2 hours, $\Delta y/\Delta t = 100 \text{ miles}/2 \text{ hours}$ or 50 mph. But what do we do when the time interval gets shorter and shorter and then is finally 0? In the appendix, we show how to solve the problem of differentiation by calculating a limit when the denominator goes to zero. (See Link 5.5.)

Link 5.5 Newton's Differential Calculus

<http://bit.ly/19wjksO>

The above curve shows the distance (y) driven by an automobile as a function of the time (t). For this trip, we can estimate the speed of the car (dy/dt) over an interval by determining the change in distance, Δy , and the change in time, t . For example, the car was at mile 43 at 50 (t_1) minutes and mile 71 at 80 minutes (t_2), so $\Delta y = (71-43) \text{ miles} = 28 \text{ miles}$ and $\Delta t = (80-50) = 30 \text{ minutes}$. The average speed over that interval, $\Delta y/\Delta t = (28/30) \text{ miles/minute} = 0.933 \text{ miles/minute} = 56 \text{ miles per hour}$. As the interval becomes shorter, the estimate becomes closer to the instantaneous speed. Newton showed up how to determine the differential, dy/dt , when the interval becomes zero. (See Appendix 5.)

When Newton returned to Cambridge in 1667 his first lectures were not on mathematics, but on optics. While at Woolstrophe, he had conducted his famous experiments with prisms and mirrors on the wall of his study.

According to Descartes the light we see from the sun is simply the result of pressure on the aether. Using the analogy of a blind person's walking stick, Descartes argued that just as the pressure on the end of the stick is transmitted instantly to the hand, so the pressure from the sun transmits light directly to the eye. Newton believed that this could not be true. For example, at night, he reasoned, one should be able to improve one's vision by running forward to create pressure on the air and aether against the eye. But it does not work so Newton concluded that Descartes was wrong.

Newton adopted a particulate (or corpuscular) definition of light, believing that light must travel from the object to the viewer. Newton's transmission theory, of course, assumed that light had a velocity. Later, as you know, it was observed that light has wave-like qualities. Newton also noted these wave-like qualities, but assumed that the *waves* were produced incidentally to the movement of the extra-fine light corpuscles through the aether. Ultimately, Newton's corpuscular or particulate theory was rejected when more precise measurements of light in the 19th century demonstrated unquestionable wave-like properties. (But in the early 20th century, we will see that other experiments led Einstein to conclude that light has particle properties.)

This was one of the few ideas of Newton that was totally rejected by the scientific community. The irony, of course, is that by the 20th century, quantum theory partially rehabilitated Newton's corpuscular theory. We now know that under certain circumstances light appears as *quanta*, (tiny particulate packets of energy), while under other circumstances light behaves according to *wave* properties.

Concerning colors, Newton was correct. In the 17th century the color spectrum was generally explained as weakness of white light. That is, as light moved across the spectrum from red to blue-violet, it became increasingly weaker as it moved from white/bright to blue-violet/darkness. Chief among the proponents for this view was **Robert Hooke** (1635–1703), prominent in the Royal Society, and well known for his *Micrographia* (1665), a book which explored the wonders of Leeuwenhoek's microscopic world. Newton's analysis of white light with his prism and mirror experiments challenged one of Hooke's chief claims to scientific expertise.

As we know, Newton discovered that if a ray of white light passes through a prism at a 45 degree angle, the light is split into the colors of the rainbow. Each color acts as an independent ray and has its own precise and specific angle of refraction. He also demonstrated that they either retained their identity if passed through a second prism, or that they could be recombined into white light again. Thus the colors of the spectrum did not represent weaknesses of white light, but rather components of white light. (See Link 5.6.)

Link 5.6 Newton's Prism Experiment

<http://bit.ly/14Z9HEX>

When Newton sent his papers on optics to the Royal Society, however, it raised the opposition and enmity of Hooke and others. Newton was appalled and being shy and wanting to avoid public controversy, he withdrew his papers, and did not ultimately publish his famous work on *Optics* until 1704 – almost thirty years after his initial studies.

We know Newton best for his work on gravity. As the story goes, one day while he sat in his garden at Woolsthorpe during his *annus mirabilis* some apples fell to the ground nearby. This got him to thinking about the power of gravity and speculating whether gravity might extend as far as the Moon. If so, what kept the Moon from falling towards the Earth?



www.sylvania.com

We do not reinvent
the wheel we reinvent
light.

Fascinating lighting offers an infinite spectrum of possibilities: Innovative technologies and new markets provide both opportunities and challenges. An environment in which your expertise is in high demand. Enjoy the supportive working atmosphere within our global group and benefit from international career paths. Implement sustainable ideas in close cooperation with other specialists and contribute to influencing our future. Come and join us in reinventing light every day.

Light is OSRAM

OSRAM
SYLVANIA



Remember, at this time, Newton accepted Descartes doctrine of the mechanical aether as the cause of gravity – including Descartes theory that the Moon was caught in a vortex – an aether whirlpool – that held it in place as it revolved around the Earth. At first, he thought of the gravity problem only in terms of the Earth and Moon, and he did not consider how gravity related in general to the universe as a whole.

From Kepler's Third Law (T^2/D^3) Newton deduced that the force that keeps the planets in their orbits must be inversely proportional to the squares of their distances from the center of the sun. Newton began to ponder this and Cartesian mechanics. At this time (1666), Newton recognized the fundamental importance of Kepler's Third Law and easily converted it into his own formula, the famous inverse-square law, which was to become the cornerstone of universal gravity. In Newton's scheme, Kepler's distance (D) become the radius (R) of the circle: then it follows that the tendency to recede decreases in proportion to the square of the radius ($1/R^2$). Newton's Law of Gravity is:

$$F = m_1 m_2 G / r^2 \text{ where } m = \text{mass, } G \text{ is a constant, and } r = \text{distance}$$

This is still not a theory of gravity because Kepler's Law explained the Moon or a planet's tendency to *recede* or move outward (or centrifugal force). Gravity dealt with attraction, which is quite the opposite of centrifugal force. What Newton realized was the Kepler's Third Law, and his inverse square law, one explaining receding bodies and the other explaining attracted bodies, added up nearly to the same thing.

How was the puzzle solved? Enter the infamous Hooke once again. Hooke wanted to renew his correspondence with the great Newton, and did so by asking Newton questions about his mechanics. While Hooke was asking the right questions, and intuitively understood the problem, he lacked the mathematics to work out the solution.

In 1680, assuming Kepler's Law, Hooke asked Newton to calculate the curve a body would describe if acted upon by an inverse square law attractive force. The answer, of course, is an ellipse. But Newton was so offended by the tone of Hooke's letter that he refused to answer.

Edmund Halley (1656–1742), the discoverer of Halley's comet, was also trying to solve Hooke's problem and went to see Newton and learned that Newton had solved the problem and much more. Newton had determined that the path of a planet would be an ellipse if gravity decreased as the square of distance.

Thus began the writing of the *Principia Mathematica*, Newton's great work that represents the culmination of the Scientific Revolution and is basis for modern science. Halley, Newton's faithful friend, very much became the mid-wife of Newton's magnum opus.

Newton ultimately came to understand that gravity must be explained in terms of two motions that belong to the Moon. First, the Moon is constantly falling towards the Earth, and second, the Moon has an inertial tendency to continue in a straight line. Together, gravity and inertia keep the Moon in orbit around the Earth. (See Link 5.7.)

Link 5.7 Moon Orbiting Earth

<http://bit.ly/1731yNo>

The Moon travels around the Earth in a roughly circular orbit. For this discussion, we will consider it perfectly circular. (It makes the math easier and would please Aristotle a great deal!) The Moon is a massive body moving through space and, according to Newton's first law of motion, a body in motion tends to continue in a straight line unless acted upon by an outside force. (See below for Newton's three laws of motion.) The Moon is, however, acted upon by the Earth's gravity. Gravity accelerates the Moon towards the Earth and causes its path to curve. The combination of these two motions causes the circular motion of the Moon around the Earth. (And the Earth around the sun, and so forth.)

Using the inverse-square law, one may calculate thus: the distance from the Earth to the Moon is 60 times the Earth's radius, so the attraction of the Earth should be $1/60^2$ ($1/3600$) of the attraction of gravity at the Earth's surface, which Galileo had shown to be 16 feet per second. The Earth, therefore, should be attracting the Moon away from her inertial path out into space at a rate of $16/60^2$, or .0044 feet per second. Subsequently the calculation of the Moon's orbit showed Newton to be correct. From this principle, Newton can generalize to other motions both on Earth and in the heavens.

Still, there were problems. For example, how to explain the attraction of the planets over empty space, and how to account for the ordinary movement of the Earth. Also, when two objects collide, one is at rest, the other is in motion, what happens? Is there a transfer of force? How does that work? Or if one object is in motion and hits two at rest, is the force divided? How? Finally, if God set the universe into motion with one *BIG PUSH*, how does the push continue? The assumption is that God's PUSH does not get any less pushy, but somehow the push, or force, or energy, gets transferred and passed around from object to object in a passive material nature.

In the *Principia*, Newton arrives at three fundamental laws of motion, which differ in an important fashion from Descartes's laws: Law 1. [Inertia] "Every body continues in its state of rest, or of uniform motion in a right line, unless it is compelled to change that state by forces impressed upon it." Law 2. "The change of motion is proportional to the motive force impressed; and is made in the direction of the right line in which that force is impressed." Law 3. "To every action there is always opposed an equal reaction: or, the mutual actions of two bodies upon each other are always equal, and directed to contrary parts."¹⁰

Newton gave, in the *Principia*, a complete theory for the universe. Newton's gravitational law was *universal*, that is, it applied everywhere in the universe, e.g. on the Earth, on the planets, and eventually on the stars. Aristotle's theory was, of course, universal but it was based on untenable assumptions such as heavenly bodies being perfect and all orbits being circles. Aristotle's theory did not agree with scientific observations. Newton's theory, however, built on Brahe, Kepler, Galileo, and others and was the result of scientific observations. Newton, by giving a plausible theory for the structure and motion of the universe, had legitimized and authenticated Copernicus and Galileo

The full title of Newton's book is *The Mathematical Principles of Natural Philosophy*. Notice, Newton is saying that the behavior of nature is based upon mathematical principles. This is a totally materialistic view of natural phenomena which is the foundation of modern science. Of course, the book was written in Latin and is typically referred to by the abbreviated Latin title of *Principia Mathematica* or just the *Principia*.



Discover the truth at www.deloitte.ca/careers

Deloitte.

© Deloitte & Touche LLP and affiliated entities.



Click on the ad to read more

Newton's *Principia* restored a comprehensive world-view, which had been lost with the collapse of Aristotelian cosmology and physics. The *Principia Mathematica* stands at the pinnacle of 17th century science because it: provided the underpinning for Copernicus's system; explained Kepler's laws of planetary motion; affirmed and expanded Galileo's work on terrestrial motion and projectiles; and, completely superseded Descartes' *Principia Philosophica*. *Principia Mathematica* is one of the most important books ever written. It is probably the most important book in science.

Thomas Kuhn says in *The Copernican Revolution* “[Newton's] mathematical derivations were without precedent in the history of science. They transcend all other achievements that stem from the new perspective introduced by Copernicanism.... From Newton's inverse-square law and the mathematical techniques that related it to motion, both the shape and speed of celestial and terrestrial trajectories could be computed for the first time with immense precision. The resemblance of cannon ball, Earth, Moon and planet was now seen, not in a vision but in numbers and measurement. With this achievement seventeenth century science reached its climax.”¹¹ Newton, writing in a letter to Robert Hooke in 1676, left us with the following oft-repeated quote: “If I have seen further it is by standing on ye shoulders of giants.”¹²

The 18th Century, known as the Age of Reason as well as The Enlightenment, did not begin with a blinding flash of light and revelation from Newton's *Principia*. The power of the book was undeniable for those who could read it and understand it, but its acceptance was slow. One reason was that very few people, even today, can understand Newton's mathematics. The *Principia* will not be found on coffee tables or night stands. Like Einstein in the 20th century, Newton's science gained acceptance through the work of interpreters, popularizes, and disciples who championed what became known as the *Culture of Newtonianism*.

But there were serious problems with the *Principia*. Regardless of its brilliance, Newton no longer could provide a *mechanical* explanation for gravity. This was a serious problem in a mechanical age. Remember that Descartes had developed a mechanical explanation for celestial movement to avoid invoking spirits, magic, the occult, or hidden, secret, non-physical actions over empty space. Cartesians accused Newton of reintroducing the occult to explain gravity because Newton could not explain the action of gravity by physical principles.

5.5 Newtonianism and The Scientific Revolution

Newtonian mechanics are known for establishing the concept of absolute space and time. *Matter* was corpuscular, and motion was described by the three laws. *Force* changes motion, rather than causing acceleration, a change in the rate of motion. When we speak of Newtonian mechanics, we refer to a world of *Absolute Space* and *Time*. This means that space and time exist independently of matter and motion. Matter in motion occupies both space and time – but neither the matter nor the motion alter or affect space and time. In this sense, space and time are eternal and immutable.

But, problems remained for Newton. How did matter hang together; what was the principle of cohesion? Did he actually propose attraction at a distance as his explanation for gravity?

A mechanistic world-view suggests that nature works more like a machine than like a living organism. One of the questions related to atomism is where is spirit or soul in an atomistic, mechanical world?

Ultimately, the question becomes what role, if any, does God play in relation to his creation. If God is the *Great Engineer*, does He have a further role after building and setting the *World Machine* in motion? Or, if God is the *Great Tinkerer*, that is if he must interact with the world to adjust and correct, what does God's tinkering say about God as Creator? It suggests God is a faulty creator. How reliable then could *Natural Law* be if it required periodic amending, constant action by the Creator?

Newton, a profoundly religious man, was deeply troubled by the atheistic implications not only of Descartes, but also of his own work and that of other mechanists. It is only in this context that we can understand his otherwise inexplicable devotion to the study of alchemy.

For Newton, physics came easily, quickly, and profoundly when he was less than 30 years old. The basic structure of Newtonian mechanics was laid down before his return to Cambridge. On the other hand, his study of Alchemy, to which he devoted more than thirty years, came with a great difficulty after a protracted struggle, and, in the end, with no significant results.

Normally, in the history of science, scholars focus on a scientists' discoveries and contributions. Almost never do we explore their failures. But in Newton's case, his failure in the study of alchemy is of great historical interest.

Alchemy implied transmutation, the *Philosopher's Stone*, the *Fountain of Youth*. The Great Chain of Being implied immutability. Was it possible for spirit, or soul, or life force, to move up and down on the Great Chain of Being?

There are ancient stories and legends of transmutation: Snow White; Sleeping Beauty; Cinderella; Beauty and the Beast; King Arthur; the Frog and the Princess; werewolves; and genie stories. All involve the spiritual world, magic, spells, and the supernatural. Alchemists searched for the *rules* of transmutation as a branch of natural philosophy. In this sense, alchemy was a close cousin of science.

With the triumph of the Age of Reason, it became increasingly fashionable to spoof and ridicule alchemy. Alchemists were best known for searching for the *Philosopher's Stone*, or the *Elixir of Life*, or the secret of transforming base metals into gold or silver.

But Alchemy had a very serious side to it – as if turning lead into silver and gold was not serious enough. Alchemy searched for the boundary between the animate and the inanimate. Or, as Newton perceived it, the boundary between disorganization and reorganization: the boundary between order and chaos; the boundary between life and death!

How did inanimate *stuff* become living *stuff*? Where does the *vital agent* in matter first occur? (For the materialist this is an irrelevant question.) Where is spirit? Where is vitality? Where is God? Leibnitz talked about living force. There developed a theory called *Vitalism* that all living matter had spirit that caused non-living matter to become living through a process called assimilation. We will discuss this theory further in the 19th century as chemistry divides into two branches, organic (living) and inorganic (non-living).

Vitalism, then, was at the heart of alchemy, as it is in most nature religions. Newton believed in the existence of a vital agent diffused through all things. And this became the central issue in Newton's philosophy/science. Newton asked how and why matter organizes itself which gets back to the question of cohesion and change within systems.

SIMPLY CLEVER

ŠKODA



We will turn your CV into
an opportunity of a lifetime

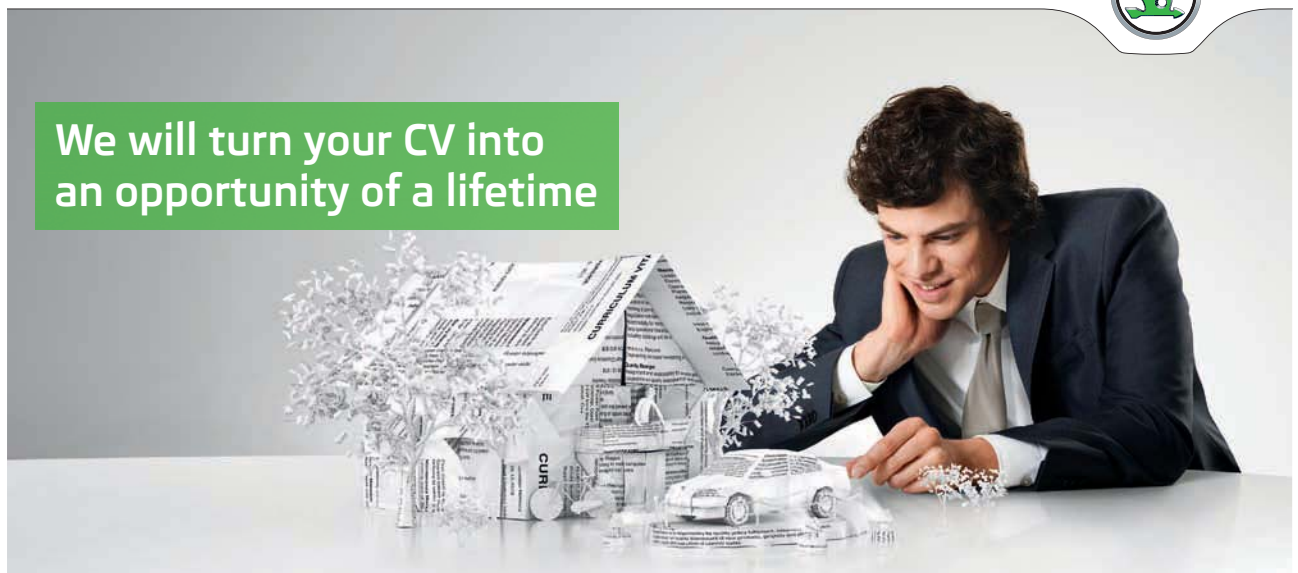

Do you like cars? Would you like to be a part of a successful brand?
We will appreciate and reward both your enthusiasm and talent.
Send us your CV. You will be surprised where it can take you.

Send us your CV on
www.employerforlife.com



Click on the ad to read more

Newtonianism explained mechanical motion within systems, but it did not explain *teleological* change within systems. That is, the Newtonian universe was a static universe and did not explain systems that were not static. Mechanical action could not explain assimilation. Initially, Newton called the vital agent the *mercurial spirit*, then the *fermental virtue*, or the *vegetable spirit*, and, ultimately, the *force of fermentation*. Newton was searching for the natural agent that God used to organize matter and put His will into effect in the natural world.

Newton's distinction between mechanical and vegetable chemistry is crucial to his solution of the theological problem posed by Cartesian materialism. Mechanical chemistry can be explained by the laws of motion. But in vegetative chemistry, we must look for some further cause. And for Newton, ultimately that cause was God. Through the vegetative principle, God constantly molded the universe to His providential design, producing all manner of generations, resurrections, fermentations, and vegetation. In summary, the secret animating spirit of alchemy kept the universe from being the closed mechanical system for which Descartes argued.

Consequently, Newton had to work out his own theology, as well. He spent an enormous amount of time reading scriptures, prophesy, commentaries, and other materials. Like Aristotle, he tried to develop a *Unified* theory for the natural and spiritual world.

Newton's choices were: Religious Orthodoxy (Trinitarianism); Materialism – in which spirit is irrelevant; Atheism – which rejects the existence of God completely; or Deism – in which he might believe that God created the world, set it in motion, and left it to run by itself.

But none of these were satisfactory to Newton. And that is why he researched in alchemy – Newton wanted to find a vital God. In the course of his search, he rejected orthodox Trinitarianism, and adopted a personal theology more akin to Unitarianism. He did not reject Jesus, but he did reject the idea of the incarnation – that Christ was God.

This created a small problem for him as Lucasian Professor. One of the requirements was the Lucasian Professor be ordained in the Church of England. He knew that in good conscious, he could not subscribe to the Nicene Creed, and thus could not keep his chair with hypocrisy. Newton asked for a permanent dispensation, which was granted.

Why did he fail? Given what he hoped to gain – a unified theory of creation – it is understandable why he worked so long and hard on his alchemy projects. The problems were more difficult than his physics problems. Newton's struggles with the religious and spiritual questions, which were central to his work, would prove uninteresting and forgettable to his followers. But not his physics.

Newton inspired a legion of disciples in the 18th century – first in England, and subsequently in Europe, especially France, and ultimately in America. Newton's *Principia* became like a testament of Nature's Bible for those who believed that God revealed himself in Two Books: His Word was revealed in the Holy Scriptures; and His Work was revealed in nature.

According to Richard Bentley (1662–1742), an Anglican clergyman who became an influential follower of Newton, Newtonian mechanics demonstrated design and order, thus confirming God's existence. (This is like Aquinas's argument from design.) Bentley's famous eight sermons, *The Folly and Unreasonableness of Atheism* were based on an apologia of Newtonian mechanics.

For English Protestants, Newton offered a home grown appeal. The Anglicans having renounced Rome as a source of religious authority, Bentley and his followers could claim that the validity of religious belief now was based on evidence drawn from science. Newton probably did not share this belief.

Newton, of course, had much greater impact among scientists than he did among the clergy. By the mid-eighteenth century Newtonianism itself had become a new scientific orthodoxy. The most influential Newtonian, however, was not English but rather was French.

Voltaire [Francois Marie Arouet] (1694–1778) became the most famous of the promoters of Newton. Voltaire was also France's best known philosopher in the 18th Century and maybe the most famous figure of the entire Enlightenment.

Voltaire, while he was in England, exiled from France, attended Newton's funeral in Westminster Abby. In his book, *Letters Concerning the English Nation* (1733), he devoted four chapters to Newton and his ideas. Later he published *Elements of Newton's Philosophy* (1738).

The acceptance of Newton was augmented by two remarkable women scientists of the 18th Century. The **Madame du Chatelet** (1706–1749), Voltaire's lover, maintained an important salon, or gathering place for scientists. Her *Institutions of Physics* (1740) became the most important interpretation of Newtonian mechanics of the time, and her translation of the *Principia* into French remains the only French version of that great work. Chatelet, along with **Laura Bassi** (1711–1778) of Italy, were two of the most important women scientists of the 18th century.

Bassi was also an early Newtonian, and is credited to carrying Newtonianism to Italy. She was the first woman to be offered a regular teaching post at a European university, and she made Bologna a major center of Newtonian studies and experimentation. She first taught *Optics*, and later the *Principia*. Thomas Jefferson carried Newton to North America and one of the great scientists of France, Pierre-Louis Moreau de Maupertuis, first advocated Newtonian theory to the French Academy of Sciences. Maupertuis anticipated Euler's law of Least Action by asserting that all action is always least action. God's economy was sublime proof of God's existence. In one of the most famous experiments of the 18th century, in which he traveled to the arctic and the equator, Maupertuis used Newtonian gravitational theory to determine the shape of the Earth.

One of the major premises of this book is that science is a cultural artifact. The assertion that science as we define it and practice it is a major western cultural phenomenon. In this age of *multiculturalism*, we think primarily of ethnic and religious cultural programs. But science, itself, is also a culture.

A culture as a common world-view has: shared values; common membership (status, initiation, rite of passage, accomplishments, and affliction); shared history (we-consciousness); and, a common language. Languages can be: verbal, written, symbolic (math), non-verbal (body), spatial (architecture), fashion (uniform), art and music, signage (sight, sound, and smell). Languages have vocabulary, context, grammar, and syntax. The Scientific Revolution was a revolution in language and culture, as well as a new understanding of nature or the natural world.



e-learning for kids

- The number 1 MOOC for Primary Education
- Free Digital Learning for Children 5-12
- 15 Million Children Reached

About e-Learning for Kids Established in 2004, e-Learning for Kids is a global nonprofit foundation dedicated to fun and free learning on the Internet for children ages 5 - 12 with courses in math, science, language arts, computers, health and environmental skills. Since 2005, more than 15 million children in over 190 countries have benefitted from eLessons provided by EFK! An all-volunteer staff consists of education and e-learning experts and business professionals from around the world committed to making difference. eLearning for Kids is actively seeking funding, volunteers, sponsors and courseware developers; get involved! For more information, please visit www.e-learningforkids.org.

Antoine Lavoisier, the founder of modern chemistry, wrote *Elements of Chemistry* (1789) which was translated into English by Robert Kerr in 1790. Lavoisier quoted the Abbe de Condillac: “We think only through the medium of words. Languages are true analytical methods. Algebra, which is adapted to its purpose in every species of expression, in the most simple, most exact, and best manner possible, is at the same time a language and an analytical method. The art of reasoning is nothing more than a language well arranged.”¹³ In other words, Lavoisier is arguing that it is impossible to separate the nomenclature of science from science itself.

Science produces facts; ideas represent the facts; and words express the ideas. Lavoisier concludes: “...we cannot improve the language of any science without at the same time improving the science itself; neither can we...improve a science, without improving the language or nomenclature which belongs to it.”

Those who participated in the Scientific Revolution shared a new cultural bond which emancipated them from old cultural bonds, primarily allegiance to church, nobility, and King. And, they became members (perhaps even citizens) of an international community of scientists.

Among the intelligencia and scientists, one of the most popular organizations to emerge in the 18th century was the Ancient Order of Freemasons. The Masons may have had their roots in the old guilds of working stone masons, but the organization ultimately became a secret fraternity of the educated and literate. Here Newtonians could gather to worship God as the Great Architect of Nature.

Masonry tended to be Deist, foster religious tolerance, support science, promote self-government, and, not the least, provide a venue for sociability. The Lodges, which spread to every major city in England and France, express a dramatic attempt of the 18th century to fashion a new cultural center independent of the church, court, guild, or social estate. The Masonic Lodges gathered in men (and women) who read science, bought books, attended lectures, and believed that society could be ordered as a Newtonian universe. As Lodges do, the Masons fostered a new, secret fraternal vocabulary of signs and symbols.

In America, Franklin, Washington, Jefferson, Adams, and Hamilton were all members of the Masonic Order. Look at the back of a U.S. dollar bill. On the left you will find *NOVUS ORDO SECLORUM* – a New Secular World – underneath a Masonic symbol, the pyramid and the *eye*. (Notice the hedge *In God We Trust*.) The Scientific Revolution became counter-cultural.

The first encyclopedia (*Encyclopedie*) was edited by **Denis Diderot** (1713–1784) and **Jean D’Alembert** (1717–1783). A massive collection of knowledge was published in 17 volumes between 1751 and 1765. Most of the famous writers and philosophers of the 18th century contributed in one way or another.

The idea of the *Encyclopedie* was to compile a summary of all useful and pertinent knowledge for the educated person. It included essays on all manner of arts, sciences, literature, and customs. There were essays, of course, on Newton and Newtonianism, but also on social, political, philosophical, and religious topics. Topics included Natural Rights, Reason, Government, History, the Bible, Atheists, and even the *Encyclopedie* itself! The *Encyclopedie* became a vehicle for propaganda as well as for the propagation of science and learning. It provided up-to-date information on scientific topics, essays on rational thinking, and applied critical analysis to the problems of human society.

Diderot, D'Alembert, and their colleagues assumed that through the Encyclopedia they could produce a summary of all knowledge. This reflects a faith that *reason* would overcome the vast regions of human ignorance, irrationality, and superstition. In a very real sense, the *Encyclopedie* became a secular substitute for Scriptures. It is the *book of knowledge* that will show you how reason, rather than faith, leads to social redemption.

You can readily appreciate that from the perspective of religious and government authority of the ancient regime in France, the *Encyclopedie* movement represented a threat. From the perspective of the King and the Church, it was subversive in that it undermined their authority. In the sense that it challenged church and state; it was a radical document. The *Encyclopedie* envisioned radical, structural change to the society.

Given its radical nature, religiously and governmentally, it is ironic that, scientifically, the *Encyclopedie* was a conservative document. That is, the editors did not envision any radical, structural change to science itself. While the political and social revolution was yet to come, the Scientific Revolution had reached its climax in Newtonian mechanics.

Diderot wrote in 1754: “We are at the present time living in a great revolution in the sciences.... I feel almost certain that before 100 years are up, one will not count three great geometers [mathematicians] in Europe. This science will very soon come to a stop where the Bernoullies, the Eulers...and D’Alamberts have left it. They will have erected the columns of Hercules. We shall not go beyond that point.... When we come to compare the infinite multitude of phenomena of nature with the limits of our understanding and the weakness of our sense-organs, can we ever expect from our work...anything but a few broken pieces, separated from the grand chain which unites all things. Even if experimental philosophy should be at work during centuries and centuries, yet the material it amasses, having become incomparable through sheer size, will still be far from exact enumeration.”¹⁴

Diderot claimed that the development of mathematics had come to the end point. In other words, we have learned God’s vocabulary. So that while we will continue to gather data – which we will convert into additional information – Diderot doubted that there is much more to learn about the fundamental structure of the universe as discovered through mathematics.

We know this was not true – but we wanted to emphasize the fundamentally conservative nature of this vision from the Enlightenment. Newton became the defining moment.

5.6 The Enlightenment and the Idea of Progress

Many scholars consider the Scientific Revolution and the Enlightenment as a single period of history. I believe we should make some distinction between the two. The Scientific Revolution was a *cultural* event usually associated with Copernicus, Galileo, Kepler, Descartes, and Newton as the leading figures, supported by a host of others. The seventeenth century began the Scientific Revolution and the eighteenth century completed it. The Scientific Revolution completed the overthrow of the Aristotelian system, both in cosmology and physics. Mathematics, this new language, was its greatest revolutionizing force, and astronomy and cosmology, its principal subjects of concern. In general, the Scientific Revolution of the 17th Century was not a movement of empirical experimentation as championed by Bacon, although observation and measurement played a major role, as we have seen in optics.

To the French, the 18th Century was the century of light, the *Siecle des Lumieres*. The Germans used the term *Aufklärung*, which was devised by Immanuel Kant. For the English, it was simply *The Enlightenment*. 18th Century philosophers envisioned that *reason*, as the new scientific spirit, could also improve politics, morals, manners, the arts, literary criticism, and even public speaking. Remember that rhetoric was one of the original liberal arts. In a sense, the Enlightenment grew out of the Scientific Revolution where reason had been so successful.

As you recall, the Greeks and Aquinas also affirmed reason. But there was a difference now. In Greek philosophy, reason was represented by Perfect Intelligence. In the Newtonian Culture, reason was embodied in the Law of Nature. Throughout the 18th Century, especially in France, reason and nature together were extolled as the keys to human prosperity. The 18th Century talked about *Natural Law* as it applied both to physics and to politics, to science as well as to government.

Emancipating God from Nature might seem as a move in the right direction, especially if this made the objective study of science possible. But separating God from Nature created two paradoxes for the 18th century that were never satisfactorily resolved.

1. *Natural Law*, as discovered by observation and experimentation, was purely descriptive, but not normative. Natural law revealed what is in nature, but not what *ought* to be. Natural law told us how nature worked, but provided no insights on how one could derive ethics from natural science. Natural law described how nature behaved, but not how we ought to live. But the philosophers of the Enlightenment hoped for more from nature. They hoped they could find moral imperatives in the laws of nature.
2. The second paradox came out of the first. One goal in discovering natural law was to be able to predict the future, totally and accurately. (This was later confirmed in the exciting prediction of the return of Halley's comet in 1759, 1835, 1910, and 1986). Natural law was linked with a search for greater determinism in nature.

At the same time, discovery of natural law was regarded as emancipating when applied to human affairs. Natural law conferred individual rights, freedom, and liberty from arbitrary authority such as church and king. The inalienable rights of life, liberty, and the pursuit of happiness, as extolled by Jefferson in the Declaration of Independence, were, after all, supposedly rooted in natural law.

Yet there is a contradiction between natural law that determines events in nature, but at the same time sets humanity free. This is especially a paradox if humans are regarded as a part of nature, not transcendent of nature.

These paradoxes were not easily resolved. Here in the 18th century we see already the tension between natural law and moral law – between science and humanity.

One resolution to the 18th Century dilemma described above was to create a new, secular faith. We have already discussed this by identifying the *Principia* as the New Testament, and the *Encyclopedie* as the new Scriptures of the enlightenment. In attacking the Aristotelian cosmology and physics, the enlightenment also brought the Great Chain of Being crashing down. The consequences for religious authority and for civil law and order were great. Prior to the 18th century, all of Europe lived in a hierarchical society which was divinely established. Authority in the society flowed from the:

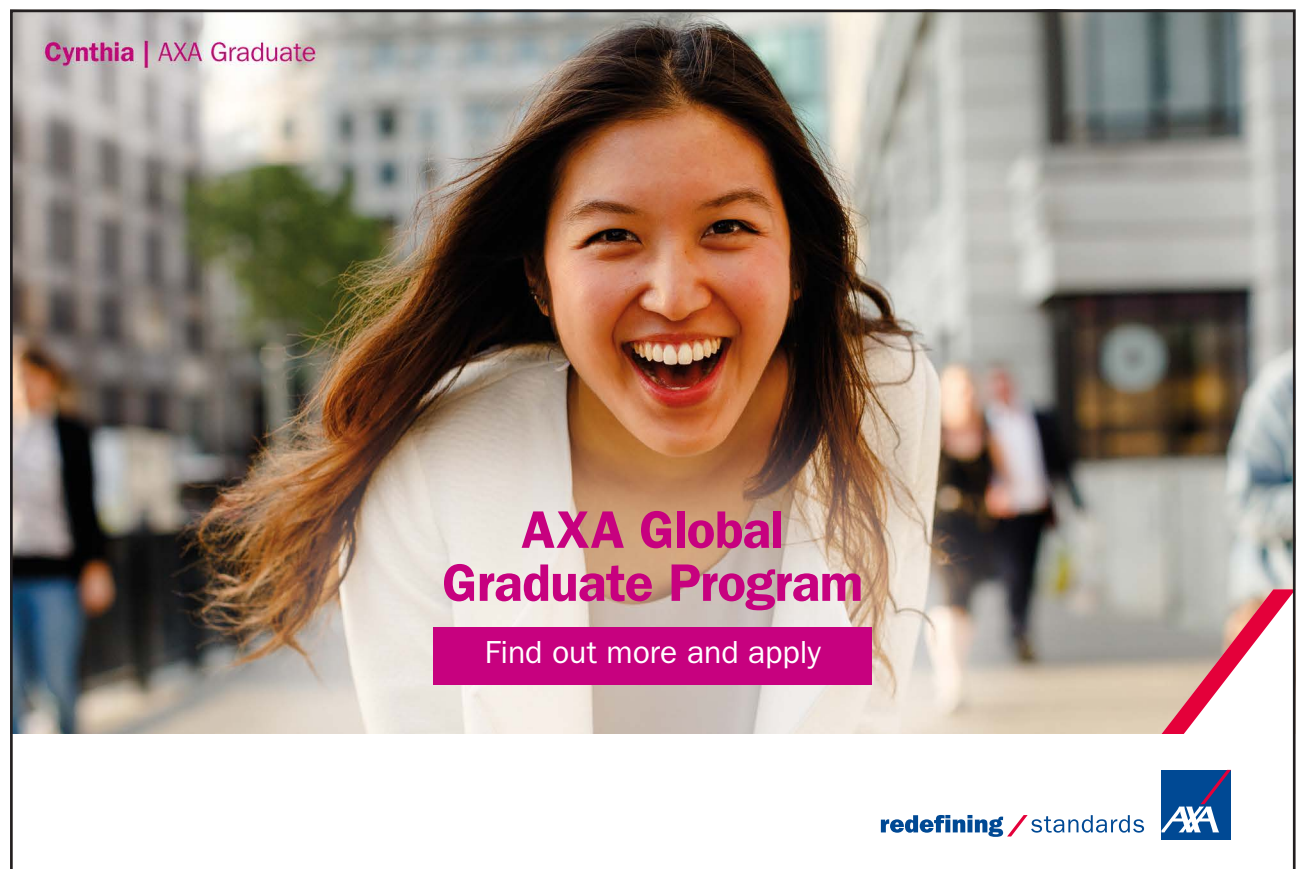

Cynthia | AXA Graduate

AXA Global Graduate Program

Find out more and apply

redefining / standards AXA

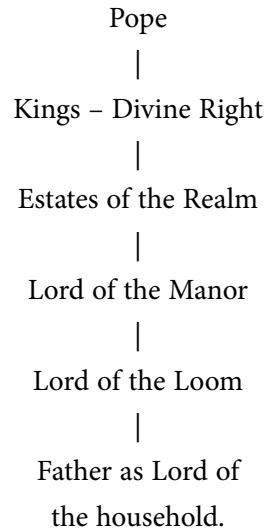

A hallmark of the enlightenment was the rejection of authority, first religious and then secular. Nonetheless, another characteristic of social change is the persistence of old ideas in the culture, especially the ideas (and vocabulary) of Plenitude, Gradation, Continuity, and Immutability. Despite the collapse of the Great Chain of Being, we are going to discover how tenaciously old ideas hang on. This is an interesting phenomena in the history of ideas – how gradually we give up old ways or categories (or vocabularies) of thinking.

What happens if we lay the Great Chain of Being on its side? We get a temporal dimension that did not exist before. *Is the world getting better or worse?* is a classic debate between ancients and moderns. The Idea of Progress makes history truly possible. Voltaire's *Essai sur les Moeurs* says that despite cruelty and the awful influence of Christianity, society does make progress. **Marquis de Condorcet** (1743–1794 CE) wrote *Historical Progress of the Human Mind*, while he was in hiding from Robespierre in 1793. His work sketches ten periods of history, the last which lies in the future. Condorcet believed that mankind continuously makes progress moving towards a utopian state.

The 18th century believed that reason was the basis of progress. It was the Age of Reason and one can establish rational laws and institutions by applying reason through natural law. Belief in reason can be optimistic or pessimistic. The optimistic belief is that human nature is fundamentally good and the pessimistic belief holds human nature is basically bad. Historically, since the 18th century, I think these have generally defined liberal versus conservative.

How do you know what is socially good versus bad? How can you define the public interest? One way is to get perspective on the society in space and time. Utopian or *travel* literature was important in the 18th century. e.g. Voltaire's *Essays on the English* (1778); and Jonathan Swift's *Gulliver's Travels* (1726).

In *The Social Contract*, **Jean Jacques Rousseau** (1712–1718) describes the Noble Savage tradition. “Man is born free and everywhere he is in chains.”¹⁵ Rousseau believes nature is good and pure but is ultimately ambiguous about the progress of civilization. (A modern statement of the same idea is Michael Blake’s, *Dances with Wolves* [1990].) Rousseau was very popular in the 18th century.

The idea of progress is the basis of our modern view of history. The 18th century is the seed-bed for the modern social sciences, although it will not be until the 19th century that social sciences as we know them were developed.

John Locke (1632–1704) was an English Philosopher. (Thomas Jefferson believed that Bacon, Newton, and Locke were the three greatest men of the Scientific Revolution.) Locke is central to understanding American political philosophy and you may know him best from his *Two Treatises on Government* (1680–1690) which underpins many of the beliefs of not only the Declaration of Independence, but also the U.S. Constitution.

Locke was fundamentally optimistic about human nature and human institutions and government which derived from a State of Nature. In challenging the Divine Right of Kings, Locke argued that the rights of the governed and governors are defined by the law of Nature, not the law of God. His vision of government was *Newtonian* – the familiar systems of checks and balances – very mechanical – in which the constituent parts of the society are engaged in machine-like harmony.

Locke’s most important work was his *Essay Concerning Human Understanding* (1690). Locke believes that all knowledge comes from experience, *a posteriori*, rather than *a priori*. He rejects a gloomy, Calvinistic view of human nature, and especially the doctrine of original sin. To Locke, humans are not inherently wicked or evil.

The Mind is born *Tabula Rasa* – that is a blank slate. We have no knowledge, or ideas, apart from our experience. There are no innate ideas, such as love, beauty, justice. We know nothing apart from experience, including our idea of God. This is a *nurture-over-nature* argument in the extreme.

But, if the mind is a blank slate, how can we know anything? If the mind is like a computer, what keeps the information from becoming a vast meaningless jumble? A chaos? The chief and dominant human faculty is *reason*. How do we know right from wrong? The Scottish Moral Sense philosophers such as Shaftesbury stated that we have a moral sense.

Baron de Montesquieu (1689–1755) is an important forerunner to modern sociology. Like Voltaire, he lived in London for a while, and was even elected a member of the Royal Society. Montesquieu's major book was *L'Esprit des Lois*, or the Spirit of the Laws (1748). Montesquieu wanted to know why societies varied so in government, culture, custom, religion and laws. Among other things, Montesquieu noted that climate, soil, and matters we do not call geography, can have a profound effect on social structure. (Auguste Comte, a 19th century scholar, is usually called the founder of sociology, a term he devised for the study of society).

In his survey of human history, Montesquieu discovers that there are fundamentally three kinds of government: despotic; monarchical; and, republican. Each kind reflected the customs, manners, economy, and laws, in sum the culture of the people governed by the systems. Montesquieu reflects that the Romans at different times enjoyed each kind of government. Thus his analysis is not inevitably progressive.

But he is not ambiguous in his assessment that the English are better governed than the French. His political system essentially agrees with Locke – that liberalism and the balance of powers are desired in the republican state. Balance of power guarantees moderation of power, and harmony and equilibrium within the society. In turn, harmony and equilibrium promote maximum enjoyment of life, liberty, and property. These are the constant themes of the Newtonian worldview as applied to government. As you no doubt recognize, they are also the principal themes of the United States Constitution.

I joined MITAS because
I wanted **real responsibility**

The Graduate Programme
for Engineers and Geoscientists
www.discovermitas.com





Month 16
I was a construction supervisor in the North Sea advising and helping foremen solve problems

Real work
International opportunities
Three work placements





Adam Smith (1723–1790), a Scotsman, was a student of mathematics and literature and professor at the University of Glasgow. In 1776, he wrote *An Inquiry into the Nature and Causes of the Wealth of Nations*. *The Wealth of Nations* developed three major ideas.

1. Historical analysis. Like Montesquieu, Smith studied history, including ancient Rome, to discover patterns of economic activity, including the origins of money, the price of goods and labor, and theories of rent and interest. In this way, Smith blazed the trail for other economists such as Karl Marx, whose analysis was also based on extensive studies of economic history. One could say that Smith is the founder of economic history.
2. Division of Labor. In terms of his analysis, Smith believed that wealth was enhanced by the division of labor. In the old guild system, the craftsman – such as the smith, or candle maker, barrel maker, etc. – would fabricate the entire item. This can be over emphasized because there was always some division of labor. But Smith sees how manufacturing can be made more profitable if the laborers are assigned specific and limited tasks. [His famous example is taken from pin manufacturing which he believed could be made cheaper if manufacture of pins was broken down into its component parts, and each laborer allocated one of the tasks]. Obviously, Smith's *division of labor* is describing the factory system adopted widely during the industrial revolution. According to Smith, it is the division of labor which increases the overall wealth of nations, and thereby raises the standard of living of capitalists and workers alike.
3. The *invisible hand*. Finally, Smith posited a profound idea that the general or public good is the product of individual activity to maximize profit and minimize loss. According to Smith, society's overall economic health is most enhanced by the unregulated separate actions of individuals, gaining and losing, but in sum, achieving maximum productivity. More concretely, he applied his theory to creating a price system. How does one establish the correct, or optimum, price for goods and services? Smith envisioned a Newtonian mechanism of natural checks and balances – which he called supply and demand. Economic laws, the invisible hand, are the best regulators of economic activity. Smith thus promotes *laissez-faire* economic policy, that the state should avoid interference in the economy except to ensure order, justice, and some limited public works such as roads and bridges.

Smith, like Newton, had deep personal belief in a benevolent God. Again, like Copernicus, Kepler, Galileo, and Newton, Smith believed that nature was regular and harmonious – and he extended this principle to human society. Like the mechanical order of the natural world, Smith believed that human society was also governed by economic natural laws. From Smith's perspective, *laissez-faire* economic policy did not favor the rich over the poor. Rather, *laissez-faire*, which did not bind the *invisible hand* of economic law, maximized economic benefit for the whole society.

5.7 Preface to the Industrial Age

The period from about 1700–1900 CE is known as the Industrial Age. Because of the foundations of the Scientific Revolution and the Enlightenment, important discoveries were made in all areas of science. The next six Parts of the book will address the areas of classical Chemistry; Electricity and Magnetism; Thermodynamics; Natural History and Geology; Biology; and the Social Sciences. To maintain continuity of discovery in a given area we will treat each of these topics separately and chronologically. But, it should be realized that discoveries were occurring simultaneously in the different areas and often discoveries in one area were helping the progress of another. To gain an overall understanding of this period it would be helpful to return and review each section after all six have been studied.

During the industrial age, not only was science being used to make material progress but scientific discovery was happening at an unprecedented rate. Modern universities were founded that joined in research activities and the industrial world realized the economic advantages of research. Nowhere was this truer than in the first of the next topics, chemistry.

ie business school

93%
OF MIM STUDENTS ARE
WORKING IN THEIR SECTOR 3 MONTHS
FOLLOWING GRADUATION

MASTER IN MANAGEMENT

- STUDY IN THE CENTER OF MADRID AND TAKE ADVANTAGE OF THE UNIQUE OPPORTUNITIES THAT THE CAPITAL OF SPAIN OFFERS
- PROPEL YOUR EDUCATION BY EARNING A DOUBLE DEGREE THAT BEST SUITS YOUR PROFESSIONAL GOALS
- STUDY A SEMESTER ABROAD AND BECOME A GLOBAL CITIZEN WITH THE BEYOND BORDERS EXPERIENCE

Length: **10 MONTHS**
Av. Experience: **1 YEAR**
Language: **ENGLISH / SPANISH**
Format: **FULL-TIME**
Intakes: **SEPT / FEB**

5 SPECIALIZATIONS
PERSONALIZE YOUR PROGRAM

#10 WORLDWIDE
MASTER IN MANAGEMENT
FINANCIAL TIMES

55 NATIONALITIES
IN CLASS

www.ie.edu/master-management | mim.admissions@ie.edu | [f](#) [t](#) [i](#) Follow us on IE MIM Experience

6 Classical Chemistry (1700–1900)

6.1 The Foundations of Modern Chemistry

Astronomy and physics, to this point in time, dealt with large objects and processes that could be observed. Newtonian science had thus far only been successfully applied to mechanics. We move now to the microscopic world, the world of chemistry and chemical reactions.

The origin of alchemy is not completely known. It may have been an ancestor of chemistry but so were practical processes: tanning of leather; making of bronze and glass. Chemistry has many roots from the making of useful products such as dyes, paints, and medicines to cosmetics and embalming. Like early mathematics, chemical procedures were discovered and then applied with no basic understanding of the science involved.

When we talk of history on a large scale, we see the huge influence of materials. We speak of the Stone Age, Bronze Age, and Iron Age recognizing that the progress of civilization was limited by the available materials for tools. Stones are natural but only a few metals occur pure in nature: gold, silver, platinum, tin, mercury, copper, lead, and a few more. All of these metals are very soft in their pure states.

The discovery of metals probably occurred by accident as rocks containing a pure metal were left in a campfire to produce, after the fire was over, a shiny, metallic residue. At first, metals were used primarily for ornaments. Pure copper and tin had some practical applications but not until the discovery of bronze was there a material hard enough to replace the stones that were used for warfare. Bronze can be made by alloying copper and tin, but other elements can be used as well. The earliest tin-alloy bronzes have been dated to the 4th century BCE. Tin and copper do not usually exist in the same geographical area so trading is involved for a society to develop the use of bronze. Bronze utilization occurred at different periods in different areas. Bronze is very useful for making weapons and shields and as a building material.

Iron oxide occurs widely in nature but a vigorous chemical reaction is required to reduce it to the metal. The red clays that are found in many places contain iron oxide. Iron is much harder than bronze and can also be machined to make small, but strong, parts for machines. Since only iron ore is needed to make iron, it can be done in a single area without trading. Traces of iron have been found as far back as the 5th century BCE in Scandinavia and iron replaces bronze somewhere between 1300 BCE and 400 CE depending upon the geographical area.

From the 16th century forward, there was an increasing metallurgical culture. This formed the basis of the Industrial Revolution (late 18th and early 19th centuries) that established economies based on coal, iron, copper, and mercury.

By the time of the Enlightenment (18th century), however, Chemistry, was without a scientific basis; it was neither quantitative nor had a useful language or fundamental theory. You will recall the Ancient Greeks believed that everything was made of four elements: *earth*, water, air, and fire. This belief remained essentially unchanged up to the eve of the Scientific Revolution. There was a good deal known about many of the earths (ores) and many modern elements had been identified: gold, silver, lead, mercury, and well as many non-elements: salt, potash, and others.

The first major discoveries between 1770 and 1800, involved the nature of fire, or combustion. From these explorations about fire, came discoveries which established the nature of two more of Aristotle's elements – air and water. Together, this remarkable thirty-year period laid the foundation for modern chemistry.

Paracelsus (1493–1541) was born Philip von Hohenheim. He later expanded his name to Philippus Theophrastus Aureolus Bombastus von Hohenheim and then added the title Paracelsus. (Celsus was a famous Roman physician and Paracelsus meant *above* or *greater than Celsus*. Note: this is not the Celsius of temperature fame.)

On June 24, 1527, at Basel (Switzerland) Paracelsus threw Avicenna's *Canon of Medicine* into a bonfire. He announced: "Your Galen, your Avicenna, and all their followers know less than the buckles on my shoes!"¹⁶

Paracelsus was a philosopher, alchemist, and surgeon who travelled Europe healing, practicing a mixture of medicine and mysticism, and even lecturing in German instead of the traditional Latin. His explanation was that his students understood German better. Here we have another radical. And, at the time the Church and King did not welcome those challenging authority. (Remember, this was just a few years after Martin Luther had nailed his 95 theses to the church door.)

Paracelsus burned books because he believed that patients were not cured by theories but by experiments! He may have been the first medical scientist! (Even at the beginning of the 20th century there were German physicians who did not sterilize instruments because they believed a doctor could not harm a patient!) The human body, to Paracelsus, was a chemical factory. This chemical machine ran upon incorporeal essences determined by vital spirits. From Paracelsus the iatrochemists were born. (These were chemists that tried to cure people with chemicals. Notice, in England the pharmacist is still called the chemist.) Basically, Paracelsus was the first to look at the human body from a chemical point of view.

Paracelsus accomplished little science or medicine, but his voice was a wake-up call that gave considerable impetus to the study of chemistry and medicine, as we shall see.

Robert Boyle (1627–1691), President of the Royal Society, author of *The Skeptical Chemist* (1661), did not believe in either Aristotle's elements or Paracelsus's principles. Boyle was a faithful Newtonian who believed in a mechanical world made up of *corpuscular particles*. But, like Newton, he lacked theory and experimentation to pursue a truly scientific chemistry.

Without theory, he plunged into experiments. He noted relationships between fire and air. He reported on many reactions and believed matter was conserved. Boyle is credited with establishing the relationship between the volume and pressure of gas. That is, the volume of a gas is inversely proportional to the pressure exerted upon it. (See Link 6.1.)

Link 6.1 Boyle's Law

<http://bit.ly/14hzk0V>

Boyle's Law of Gases states that as pressure increases, volume decreases proportionally and vice versa. Mathematically this means $PV = c$ where P = pressure, V = volume, and c is a constant. All gases behave according to Boyle's Law. The graph shows volume as a function of pressure. (Temperature must be held constant as it also affects pressure and volume.) Clearly finding such a quantitative relationship says something fundamental about the nature of gases.

About 1670, J.J. Becher proposed that when something burned, it gave up a substance. Becher's follower, George Ernest Stahl, named the substance *Phlogiston*. Phlogiston was hypothesized to be an oily, moist, material that gave matter its taste, odor and combustibility. Phlogiston could do anything. Fire (i.e. Phlogiston) should rise to the top of the universe and become part of the heavens. Becher thought phlogiston was a substance that could be found and measured. Notice that his is an investigative attitude that Aristotle would not have had.

Phlogiston was supposedly released when wood burns and when metals rust. Air carried away phlogiston and plants absorb it from the air. Combustion does not occur in vacuum because there is no air to carry away the phlogiston. When metal is burned it becomes heavier, but, of course, phlogiston, contains *levity* and when leaving metals makes them less buoyant. (If you replace the word *phlogiston* with *energy*, you can go a long way with many of these arguments. But, eventually, you get into contradictions as Phlogiston came to be used as an explanation for all sorts of properties.)

In the 18th century, the study of gases became important. In 1756, **Joseph Black** (1728–1799), Professor at Edinburgh and inventor of the analytical balance, showed that solids like magnesium carbonate and limestone (calcium carbonate) lost a common gas, CO₂, when heated. He called this gas *fixed air*, because it seemed to be fixed in solids and it did not support combustion. Black showed he could make fixed air by passing air over heated charcoal. He also found the gas in exhalation exhaust. (He was right on the edge of a major discovery.)

The most important thing about pneumatic chemistry, or the study of gases, is that it allowed measurement, you could get numbers. Weight, pressure, volume, and temperature were now quantifiable. **Henry Cavendish** (1731–1810), in England, a wonderfully eccentric and independently wealthy experimenter, found that several metals dropped into acid released a gas. He found this gas had weight and that it would burn with common air and make dew. (He was combining hydrogen with oxygen.) He believed he had discovered phlogiston.

After further, very careful experiments in 1783, Cavendish made perhaps the most important pronouncement in chemistry prior to Lavoisier and Dalton. Cavendish had determined that water was made up of two gases, phlogistonated-air (hydrogen) and dephlogistonated-air (oxygen) and that they combined in 2 to 1 volume proportions.



"I studied English for 16 years but...
...I finally learned to speak it in just six lessons"
Jane, Chinese architect

ENGLISH OUT THERE

Click to hear me talking before and after my unique course download

Joseph Priestly (1733–1804), from the North of England, was a dissenter clergyman, who ultimately publicly embraced Newton's Arianism, i.e. that Christ was exceptionally good man and prophet, but no God. His main work was the study of gases, or *airs*. Priestly undertook to study all airs and experimented with carbon dioxide, hydrogen, nitric oxide, nitrous oxide, hydrochloric acid, sulfur dioxide, and other gases. He rarely weighed his materials so his work was mostly descriptive.

Of course, his most famous work was the discovery of oxygen. (There is some argument that Scheele and Lavoisier also deserve some credit for this discovery.) Priestly discovered that he could heat the calx of mercury (mercuric oxide) and the gas produced burned very brightly and supported the life of a mouse long after common air would not. This was an old experiment but others had not investigated the gas that was produced. Priestly had made a discovery of immense importance. He had found the active substance from air that combined with other materials and referred to it as dephlogisticated air. However, he did not appreciate the nature of his discovery. That would come from Antoine Lavoisier. (Still, today, we call combining with oxygen – other substances that readily assume a negative charge, e.g. fluorine – *oxidation* and the reverse processes *reduction*.)

Antoine Lavoisier (1743–1794) was the son of a French nobleman and, in fact, a nobleman himself. He studied all areas of science. Lavoisier carried out many quantitative chemical reactions and believed heat, as well as mass, was conserved. The key to Lavoisier's chemistry was the analytical balance. Balances have been known since antiquity but Joseph Black had recently developed the much more sensitive instrument that Lavoisier used.

He summed up his many experiments in his *Elements of Chemistry* (1789). Lavoisier wrote, "We must lay it down as an incontestable axiom that in all the operations of art and nature, nothing is created; and equal quantity of matter exists both before and after the experiment."¹⁷ This principle becomes known as the *conservation of mass*. In effect it says that matter is neither created nor destroyed in chemical reactions. (See Link 6.2.) (However, matter can be converted to energy and vice versa in nuclear reactions.)

Link 6.2 Conservation of Mass

<http://bit.ly/18IKoEj>

Lavoisier observed that there were quantitative reactions involving heat and thought that heat was a substance which he named *caloric*. For example, heat added to water gave steam.

Lavoisier decided that air was a mixture of gases. In 1774 Priestly visited Lavoisier in Paris. There is no record of their conversations but it is reasonable to assume they compared experimental results and theories. Lavoisier discovered that air reacting to make *calx* lost 1/6 its volume. (Air is about 20% oxygen. Calx is a term sometimes used to mean calcium oxide but often as a general term for metallic oxides. Hence mercury calx would be mercuric oxide.) Lavoisier concluded that air is not an element but that it contains an element (oxygen) that supported combustion, life, etc. Lavoisier named Cavendish's phlogiston *hydrogen*. Lavoisier concluded that the reaction of hydrogen with air to make dew was actually the combining of hydrogen and oxygen to make water. In effect, Lavoisier killed the phlogiston theory but Priestly never accepted Lavoisier's conclusion.

Lavoisier also showed that burning diamonds and graphite produced the same gas. (This was Black's carbon dioxide, CO₂.) This was the first example of allotropism. Allotropes are different crystal structures of the same element. Diamonds and graphite, whose properties are so different, are actually just different crystal structures of pure carbon. Another example of allotropism was a problem that had bothered churchmen of medieval times. Tin, used to make organ pipes, while machined into shiny, smooth surfaces, would slowly become grainy, dull and crusty, breaking into powder. This was called *tin disease* and some attributed it to an attack by the devil on the church. It was eventually shown, however, that tin has a different crystal structure to which it slowly transitions in the cool temperatures that were common in un-heated European churches.

Recall that Black had shown that the gas we exhale is carbon dioxide. Lavoisier experimented by having a person working on a treadmill and measuring the oxygen he required. Lavoisier concluded correctly that we burn organic matter and produce the by-product of carbon dioxide. This was the first step towards understanding metabolism and realizing that we obtain our own energy by burning organic matter, i.e. that we are heat-engines.

Lavoisier has been called the Father of Modern Chemistry. Lavoisier's work changed chemistry so much, that he and his followers perceived the need for a new, and modern system of chemical names and nomenclature to sweep away the dead language, and pseudoscience of alchemy. In his *Method of Chemical Nomenclature* (1787), Lavoisier wrote: "That method which it is so important to introduce into the study and teaching of chemistry is closely linked to the reform of its nomenclature. A well-made language, a language which seizes on the natural order in the succession of ideas, will entail a necessary and even a prompt revolution in the manner of teaching. It will not permit professors of chemistry to deviate from the course of nature. Either they will have to reject the nomenclature, or else follow irresistibly the road it marks out. Thus it is that the logic of a science is related essentially to its language."¹⁸ Lavoisier provided the naming system for chemistry that we still use today. For example, when metals such as mercury, copper, or iron react with oxygen, the products are all called oxides, e.g. iron oxide.

Lavoisier supported the French revolution by making gunpowder for the Republic's army. But, he had also been a tax farmer and aristocrat. Lavoisier had criticized Jean Paul Marat's studies of fire and was executed by the Revolutionary Council in 1794.

6.2 Chemistry Becomes a Science

Three advances were necessary to give chemistry Revolution a firm, scientific foundation. We have discussed the first two.

1. Chemists needed a breakthrough to determine that Aristotle's Fire, Water, Air, and Earth were not the fundamental elements of matter;
2. A modern, universal nomenclature was essential so that chemists everywhere could share and compare results; and,
3. Chemistry had to be established as a mathematical science, with a plausible, theoretical basis.

Enter a self-educated Quaker named **John Dalton** (1776–1844). Dalton was an unlikely hero of the Scientific Revolution. Unlike Cavendish and Lavoisier, Dalton was relatively poor. He had to make his own living as a tutor, largely teaching arithmetic in the city of Manchester.

Dalton did not establish his own lavish laboratories, nor did he have access to advanced facilities or well-stocked libraries as did Cavendish, Priestly, and Lavoisier. Dalton did only a little experimental work. He traveled around England taking air samples and recording meteorological data. He analyzed the air samples and found that samples from different places had the same proportions of gases.

Dalton is one of the first theoretical chemists who, using Newtonian mechanics and his own sense of physical reality, developed an esthetics of science. Dalton's theories were compelling because of their beauty in terms of their logic, symmetry, and simplicity. Indeed, more than any other scientist to date, Dalton was a picture drawer, he thought visually – he would be at home today where no chemistry lecture is complete without view graphs and illustrations.

Dalton did not believe that experimentation was the be-all and end-all of scientific research. This is not to say that Dalton was not a superb observer. His primary interest was the atmosphere and climate. He took careful and copious notes of his daily observations.

In Spain, **Joseph Louis Proust** (1754–1826) believed the composition of chemical compounds did not vary from compound to compound. Rather, Proust proposed that elements which combined to form compounds did so in definite, fixed and reliable proportions.

There was controversy whether this was actually the case, and Proust through careful, repeated experiments determined that it was true. “The stones and soils beneath our feet, and the ponderable mountains, are not mere confused masses of matter; they are pervaded through their innermost constitution by the harmony of number.”¹⁹

As Dalton contemplated the atmosphere and its composition, he ultimately asked the same question about matter that Newton posed. What was the principle of cohesion? What held the gases together in the atmosphere? Dalton determined that the composition of the atmosphere was universally the same (for all intents and purposes). Well versed in Newton, Dalton contemplated a corpuscular, or particle chemistry in which each of the atoms (if we may call them that) were treated as real things. He even made small wooden beads to represent the atoms. He then envisioned how atoms combined to make different compounds. Now the big question. Were all the atoms of the same size and weight? Here was the big theoretical breakthrough, a complete departure from the ancient Greek atomists.



In the past 5 years we have drilled around

95,000 km

—that’s more than **twice** around the world.

Who are we?
We are the world’s leading provider of reservoir characterization, drilling, production, and processing technologies to the oil and gas industry.

Who are we looking for?
We offer countless opportunities in the following domains:

- Operations
- Research, Engineering, and Manufacturing
- Geoscience and Petrotechnical
- Commercial and Business

We’re looking for high-energy, self-motivated graduates with vision and integrity to join our team.

What will you be?

careers.slb.com

Schlumberger

Dalton postulated that atoms of the *same* element were alike, but atoms of each element differed one from the other in size and weight. This is a remarkable conceptual breakthrough. Here is an excerpt from a paper read by Dalton in November, 1802. It was a paper on *the Proportion of the Gases or Elastic Fluids Constituting the Atmosphere*: “The elements of oxygen may combine with a certain portion of nitrous gas, or with twice that portion, but with no intermediate quantity.”²⁰ There is some possibility that this sentence was added after he read the paper and before he actually published it in 1805. (Little does it matter whether he was announcing his idea in 1802 or 1805. Most histories state that Dalton presented his atomic theory in 1803.)

Dalton concluded that Newton’s atoms differed in weight from one element to the other. But, for composition of compounds to be constant, the atoms of a given element must all weigh the same. Dalton concluded, in 1803, in his law of Multiple Proportions, that atoms must combine in simple, small number ratios to form compounds. He developed a system of symbols that would last until Berzelius simplified it further.

Dalton, of course, could not determine the size and weight of any atom, but as everyone now realizes, he could determine the *relative size and weight* of the atoms. And taking hydrogen, the lightest, and giving it arbitrarily the number one, you could calculate the relative weight of oxygen, or any other element in a compound. (See Link 6.3.)

Link 6.3 Dalton’s Symbols and Atomic Weights

<http://bit.ly/13EeQRy>

If you look at the figure closely you will see that Dalton gave oxygen a weight of 7 compared to hydrogen being 1. This is because Dalton selected the simplest ratios for compounds and concluded water was HO not H₂O as we know now. If water was HO the relative weights of oxygen to hydrogen would be 8 to 1. We can assume Dalton got 7 to 1 because of inaccuracy in weighing the two gases in the reaction.

There is a lot of chemistry to be done after Dalton, but we now have a firm mathematical foundation for it. The Law of Definite Proportions established chemistry as a mathematical science, and further affirmed that nature was mathematical as established by Galileo, Kepler, and Newton.

In 1803, John Dalton provided the key to making chemistry a science. There were elements that did not change, each element had atoms of a particular weight, the atoms combined in a great variety to make compounds. (Later we will use the term *molecule* for combinations of atoms.)

To be able to do proper chemistry, we need to know the relative weights of atoms so that we can combine them in proper ratios. Bernard Jaffe, author of *Crucibles: The Story of Chemistry From Ancient Alchemy to Nuclear Fission* (1930) said about Dalton: “Dalton’s Atomic Theory remains today one of the pillars of the edifice of chemistry – a monument to the modest Quaker of Manchester.”²¹ I personally think we should change the word *chemistry* to *science* or even *the Enlightenment*. And, it is clearly not “one of the pillars...of chemistry”, it is the *foundation*.

Here, for the first time, is a logical theory of the microscopic. Remember, Aristotle’s Elements were really the three common physical states plus energy. Certainly, Aristotle’s concept was a good basis for describing the physical properties of matter, but those states were by no means immutable and he must have known it. And, Aristotle certainly gave not even a hint of understanding chemistry.

At this point, I want to insert a thought from the anthropologist Joseph Campbell who says that our mythology, the origin of metaphysics, began with the observation of nature and man’s logical extrapolation of himself to create *gods*. This mythology was used to explain nature. According to Campbell, because of science we have developed much better observational abilities, both of the macroscopic and microscopic worlds.

But, we have enshrined in our traditions a 2000 (or more) year-old-mythology. Campbell says this is the basis for the apparent conflict between science and religion. I find Campbell’s arguments compelling as I notice that the conflict so often revolves around *literal* interpretations of scriptures. For example, Joshua stopping the sun. I have stood at the archeological dig in Jericho and could readily believe that a day might seem a week under those harsh, desert conditions. Especially with an enemy army surrounding you. Further, to a geocentric culture with no way to measure time other than the sun, it is very easy to imagine even a casual statement becoming a time honored myth.

Physics books at the turn of the 20th century stated that clouds could not rise above 20,000 feet and gave good arguments for this fact. When people started climbing to higher altitudes, the books changed. Biology books used to state that the Mexican Fruit Fly could fly faster than the speed of sound. A physicist in the 1960s constructed model flies and found out they disintegrated at speeds greater than about 10% of the speed of sound. (The speed of sound at sea level is about 670 mph.) He also pointed out that his models became impossible to see at about 60 miles an hour. The writer ultimately traced the original publication to a biologist who went to Mexico in the 1920s. As he stepped off the train a fruit fly hit him in the face, producing a bloody welt. When he asked what hit him, his host said it was a fruit fly and they flew so fast you could not hear them. The biologist recorded in his textbook that fruit flies fly faster than sound and this erroneous fact was copied from book to book for half a century.

After Dalton's theory of atoms and elements, the search was on to make sense of the atomic weight scale. Because of Lavoisier's quantitative chemistry, accurate work could now be done. However, as we shall see, it will be about 1920 before we can truly measure atomic weights. In fact, we will measure the dimensions of the nucleus, before we can measure atomic weight directly.

An indication of the importance of the chemical industry of this time, was the establishment of a chemical company in Newark, Delaware, by Pierre du Pont de Nemours, in 1804. Du Pont had emigrated to America with his sons to avoid the fate of Lavoisier. Du Pont opened a chemical factory initially making gun powder to sell to Napoleon. One important aspect of the rapid growth of the chemical industry was the research that was fostered by the commercial success of chemistry. Besides medicine, chemistry was the first area of science to become a major industry and to attract industrial funding. The first patent issued by the U.S. Patent Office was in chemistry.

J.J. Berzelius (1779–1848) analyzed thousands of compounds to find accurate relative weights. He also invented the modern notation of chemical compounds that results in the chemical algebra which is called stoichiometry. For an example of the archaic alchemical versus Berzelius notation, see *Crucibles: The Story of Chemistry*, Jaffe, Bernard, Dover, New York, 1930, p. 109.

Excellent Economics and Business programmes at:



university of
 groningen



“The perfect start
of a successful,
international career.”

CLICK HERE
to discover why both socially
and academically the University
of Groningen is one of the best
places for a student to be

www.rug.nl/feb/education

Gay-Lussac and others brought evidence to support the theory that equal volumes of gases, at the same temperature and pressure, contain equal numbers of atoms. But, why should this work if equal weights do not contain equal numbers of atoms? This was the major complicating factor in determining the nature of chemical compounds and reactions. The anti-atomic argument continued into the beginning of the 20th century.

The invention of electric battery or pile by Volta, allowed Davy and his protégé Faraday to discover new elements by electrolysis. (Some element can only be isolated that way.) (In 1800, Nicholson, an engineer, had electrolyzed water to produce hydrogen and oxygen.) In spite of the puzzles of atomic weights, evidence accumulated to support the atomic hypothesis. Also, when salts like sodium chloride were melted and an electric current was passed through them, the metal always collected at the negative electrode (cathode) and the other element at the positive electrode (anode).

Berzelius concluded that electrical forces must be involved in chemical affinity. Probably, this conclusion was the most important idea, next to Dalton's atoms, to come from 19th century chemistry. Berzelius thought that every atom had both a positive and a negative charge, one of which was greater than the other, and only oxygen was totally negative. He thought the attraction of atoms was caused by the negative end of one atom attracting the positive end of another. But, if this were true, there could be no molecules of two atoms of the same kind.

The secret to solving the atomic weight problem, however, lay in the hypothesis of **Amadeo Avogadro** (1776–1856). In 1811, Avogadro proposed that equal volumes of gas contained equal numbers of molecules. And, with reactions such as hydrogen gas and chlorine gas producing hydrogen chloride that implied both hydrogen gas and chlorine gas had molecules of at least two atoms each. As we will see later, this proposal was a key to determining correct atomic weights and molecular structures. (See Link 6.4.)

Link 6.4 Avogadro's Hypothesis

<http://bit.ly/17NwUpD>

But, where was God in all this chemistry? God still existed in the formation of organic compounds in that vitalist theory effectively said that organic compounds contained vital spirit and could only be made by nature, not by man. This is the closest to a Great Chain that chemistry would ever come. But in 1828, Wöhler synthesized urea, a well-known compound found in urine. This was a scientific disproof of vitalism but it didn't persuade the vitalists.

Then, in the middle of the 19th century, two more developments catapulted chemistry as a science in the true Galilean sense. First, in 1859, Bunsen and Kirchoff, German chemists, developed the spectroscope. Various elements were known to give discrete spectra when heated. That is, by placing the element in a fire, the light produced, when broken up by a prism, consisted of only a few spectra lines instead of the continuum of a rainbow. And, these *line spectra* were fingerprints of the elements.

Bunsen and Kirchoff made a combination telescope and prism that could be pointed at a light source to see the spectrum. By dipping a platinum wire into a solution containing an element and then placing it in a flame, they characterized the spectra of known elements. Others looked at stars and could determine their elemental composition. Later in sunlight the spectrum of hydrogen was seen along with a new spectrum of an element not yet found on Earth. They realized the sun contained an unknown element and named it helium after the Greek Helios for sun. (See Link 6.5.)

Link 6.5 Spectroscope

http://scitechantiques.com/spectroscope_move/

Franklin had measured the lightening in the sky, but Bunsen & Kirchoff had reached all the way to the heavens and analyzed the chemical content of the stars!

Through the first half of 19th century, arguments went back and forth as to the number of atoms in each compound. An obscure chemistry teacher in Turin, Amedeo Avogadro, had proposed the term *molecule* and had hypothesized that the number of molecules in a given volume of gas, no matter what the gas, were the same.

This was complicated by the fact that Berzelius's bonding theory would not permit two atoms of same element to bind together to form a molecule. Furthermore, the great Dalton believed the simplest structure would always be correct and had claimed that water was HO.

By 1860, there was chaos with the argument over what were the basic ratios of the atomic weights of elements. Many reactions were known but arguments abounded as to which were the correct assignments.

The First International Chemistry Conference was held in Karlsruhe, Germany in 1860. Most of the leading chemists attended and **Stanislao Cannizzaro** (1826–1910) proposed they reconsider the Avogadro hypothesis. By the end of the Conference all were in agreement and a table of atomic weights had been established. Using Avogadro's equal volumes assumption:

1. Vol H + 1 Vol Cl = 2 Vol HCl

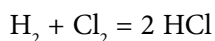

2. Vol H + 1 Vol O = 2 Vol's water

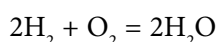

And, so forth.

The concept of the molecule was accepted and a consistent set of formulas and atomic weights was finally established!



American online
LIGS University
is currently enrolling in the
Interactive Online **BBA, MBA, MSc,**
DBA and PhD programs:

- ▶ enroll **by September 30th, 2014** and
- ▶ **save up to 16%** on the tuition!
- ▶ pay in 10 installments / 2 years
- ▶ Interactive **Online education**
- ▶ visit www.ligsuniversity.com to find out more!

Note: LIGS University is not accredited by any nationally recognized accrediting agency listed by the US Secretary of Education. More info [here](#).



By this time, chemistry was a vast confusion of thousands of compounds that underwent tens of thousands of reactions with no rhyme or reason. Then, enter **Dmitri Mendeleev** (1834–1907) who observed the periodic nature of the elements. As one started up the table of elements, in order of their atomic weights, every so often their properties started to repeat. In 1869, he made a table of repeating periods. When an element didn't seem to be similar in properties to the one above it, he skipped a position.

The result was that similar elements like sodium and potassium, beryllium and magnesium, carbon and silicon, etc., lined up above each other. But there were six blank spaces, such as below aluminum and Mendeleev predicted these elements were unknown elements that would eventually be found. They were all found, although the last technetium, which is radioactive, was not found until half way through the 20th century. (See Link 6.6.)

Link 6.6 Mendeleev's Periodic Table

<http://yiancs.tripod.com/CHEM4U/mendeleev.gif>

Gallium (called eka-aluminum by Mendeleev) was found only 5 years later, in 1874. Mendeleev's table became a unifying concept in chemistry! (See Link 6.7.)

Link 6.7 Modern Periodic Table

<http://www.ptable.com/>

Lavoisier, Dalton, Berzelius, and Mendeleev remain today as the four greatest names in the development of chemistry as a science.

Svante Arrhenius (1859–1927) is perhaps the first physical chemist. Certainly, many scientists of the period contributed to both chemistry and physics. (As we shall see later, Faraday was a particularly major scientist in both arenas.) But, Arrhenius brought physics and chemistry together in a way that no one had done before.

Arrhenius attended the University of Upsala as had his hero, Berzelius, 80 some years earlier. Arrhenius proposed to develop a theory of conductivity in solutions for his dissertation. His professor rejected his proposal but Arrhenius persisted and his thesis was rejected by the faculty at Upsala. But, they granted him a doctoral degree anyway because of his brilliance as a student! (This was the same university that had rejected Berzelius's proposal for a modern way of representing chemical reactions! Arrhenius went on to win the Nobel Prize in chemistry as Berzelius likely would have if the Nobel Prizes had existed during his lifetime.)

Pure water does not conduct an electric current and neither does a salt like sodium chloride (NaCl). But salt dissolved in water conducts electricity while sugar dissolved in water does not! Arrhenius's theory was that some molecules dissolved in water forming a solution that had charged particles or ions. ($\text{NaCl} \rightarrow \text{Na}^+ + \text{Cl}^-$. Positive ions are called cations and negative ions, anions.) It was these ions that conducted the current from one electrode to the other. This first successful theory of solutions would not be supplanted until the twentieth century.

Arrhenius also proposed the first theory of acids and bases. Acids, according to him were compounds that produced H^+ in solution and bases produced OH^- . The two ions reacted to produce water. For example, hydrochloric acid, HCl would react with sodium hydroxide, NaOH to produce water and a salt.

According to Arrhenius: the following reactions would occur in water:

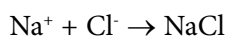
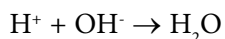
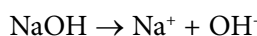
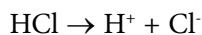

In summary: $\text{HCl} + \text{NaOH} \rightarrow \text{NaCl} + \text{H}_2\text{O}$

Arrhenius initiated the study of chemical kinetics and the actual mechanisms of chemical reactions. By mechanism, we mean the individual molecular reactions that add up to the overall reaction. Arrhenius gave us the concept of activation energy for a reaction around 1888. Arrhenius determined that an energy barrier – the difference in initial energy of reactants and the necessary higher energy that must be reached at some point in the reaction – controls the rate of a reaction. Arrhenius actually gave a quantitative formula for determining activation energies.

6.3 Organic (living) Chemistry

In 1800, organic chemistry was very crude. A small number of organic compounds were known such as waxes, fats, oils, acetone, sugars, oxalic acid, urea, and alcohol. According to the vitalist theory, organic compounds had to be found in nature, they could not be made in the laboratory. Even the great Berzelius supported this theory. Organic compounds had to be extracted from nature and then studied in the laboratory. Chemists that did this kind of work became known as natural product chemists.

Lavoisier made the first systematic studies of organic composition in 1786. He defined organic chemicals as combinations of oxygen with radicals that contained carbon and hydrogen. If of animal origin, they could also contain nitrogen and phosphorus. Lavoisier determined carbon content by combustion. Gay-Lussac and Louis Thenard made improvements in 1810 and Berzelius further refined methods of elemental analysis from 1814 forward. Berzelius tried to determine molecular formulas.

During the period 1811–1817, Berzelius analyzed a sufficient number of organic compounds to prove that they obeyed the same laws as inorganic compounds. He further developed his bonding theory based upon radicals.

Gay-Lussac and Thenard found that the ratio of hydrogen to oxygen in sugars, starches, woods, and gums was the same as in water, namely two hydrogen atoms for each oxygen atom. The other main component of these compounds was carbon. Hence, they acquired the name *carbohydrates*. *Carbohydrate* is misleading because *hydrate* means a compound containing water. And, while the ratio of hydrogen to oxygen was the same as in water, these compounds did not contain water units as do some inorganic hydrates.

Justus von Liebig in 1823 published the analysis of silver fulminate and Friedrich Wöhler in 1824 of silver cyanate, two strikingly different compounds with the same percentages of silver, carbon, nitrogen and oxygen. This suggested that there were different chemical compounds with the same composition which, in turn, implies they must have different arrangements of the atoms to have different structures.



DON'T EAT YELLOW SNOW

What will your advice be?

Some advice just states the obvious. But to give the kind of advice that's going to make a real difference to your clients you've got to listen critically, dig beneath the surface, challenge assumptions and be credible and confident enough to make suggestions right from day one. At Grant Thornton you've got to be ready to kick start a career right at the heart of business.

Sound like you? Here's our advice: visit GrantThornton.ca/careers/students

Scan here to learn more about a career with Grant Thornton.



© Grant Thornton LLP. A Canadian Member of Grant Thornton International Ltd



Friedrich Wöhler (1800–1882) was a young German chemist who set out to make organic compounds in the laboratory. He wished to disprove the Vitalist theory. And, in 1828, by heating inorganic ammonium cyanate (NH_4CNO) Wöhler produced the natural product Urea ($(\text{NH}_2)_2\text{CO}$) which had previously been crystallized from urine. By now, Berzelius was considered the greatest authority on chemistry. Wöhler wrote to Berzelius saying: "...I can prepare urea without requiring a kidney of an animal, either man or dog."²² Berzelius confirmed that Wöhler had succeeded. (See Figure 6.8.)

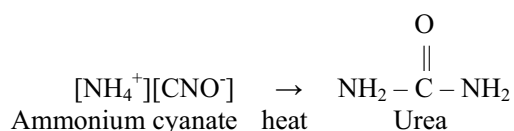

Figure 6.8 Synthesis of Urea

Urea is found in mammalian urine. (It is produced by mammals to remove excess nitrogen.) At that time, chemists characterized chemical compounds by elemental analysis, color, crystal form, melting point, boiling point, taste, smell, and elemental analysis. When ammonium cyanate is heated, it rearranges to urea that has a melting point of 132.7° C. While the elemental analysis gives the same formula (CH_4ON_2), the properties of the two compounds are quite different.

Supporters of the Vitalist theory claimed urea was sort of an in-between compound, not really organic. But the door had been opened.

By 1860 Bertholot claimed the total synthesis of organic compounds. (Amino acids, even proteins are synthesized today.)

A theory for the structures of organic molecules was needed. Dumas and others proposed various radicals such as *etherin* (ethylene, $-\text{C}_2\text{H}_4-$) that could have things added to them to become compounds such as ethyl alcohol, ethyl ether, ethyl acetate, ethyl chloride, and so on. While the etherin theory was not complete, it came very close by proposing such correct reactions as: C_2H_4 (ethylene) + H_2O (water) = $\text{C}_2\text{H}_6\text{O}$ (ethyl alcohol or ethanol). In fact, this very reaction is used today in an industrial process for making ethanol.

In 1837, **Auguste Laurent** (1807–1853) developed the *nucleus* theory in which there was a three dimensional structure in the form of radical *cubes* with atoms added to or removed from the faces to give different properties. This allowed such exchanges as chlorine replacing hydrogen without a change the geometry. It was also the beginning of modern stereochemistry. The French chemist, Charles Gerhardt, was a strong supporter of Laurent and carried the idea much further in the 1840s.

Berzelius and the establishment strongly opposed Laurent and Gerhardt making them essentially outcasts. Laurent had actually been the first, in 1846, to propose that elementary gases such as oxygen and nitrogen were diatomic molecules. As we mentioned earlier, by 1860 the idea of diatomic gases was accepted.

Wurtz was a classmate and friend of Gerhardt who supported him also. In 1849 Wurtz discovered methylamine and ethylamine and suggested that these were molecules of ammonia with one hydrogen atom replaced by a methyl (CH_3 -) or an ethyl (CH_3CH_2 -). August von Hoffmann then isolated secondary and tertiary amines which led further support to Wurtz and, hence, Laurent. In 1853 Laurent proposed a comprehensive theory of type compounds. Laurent died in 1853 and Gerhardt in 1856, both on the verge of great success.

Organic chemistry was organized around classes of compounds but there was still no coherent theory of structure. In 1856 William Henry Perkin attempted to synthesize quinine and made, instead, a new dye that was named *mauveine*. The dye produced the very difficult to obtain royal purple color and at one point was worth more per pound than platinum.

Organic chemistry was progressing at a very rapid rate. **Friedrich Kekulé** (1819–1896) in 1858 dreamed of carbons forming a chain and the idea of the carbon skeleton to make organic compounds was discovered. Carbon could have four bonds (valence) and could connect to itself or to other atoms to make organic molecules. A few years later Kekulé would dream again, this time about snakes eating each other's tails, and gain insight into the structure of the unusual molecule benzene. Benzene gives rise to an important class of compounds that are called aromatic molecules. (See Figure 6.9.)

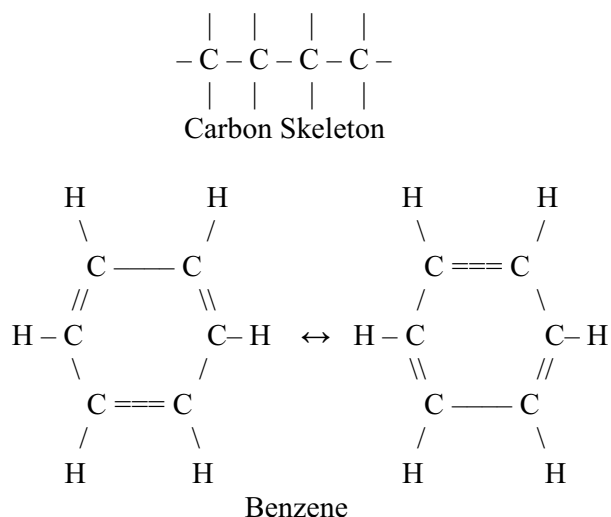

Figure 6.9 Kekulé's Carbon Skeleton and Benzene

Kekulé made two huge contributions to early chemistry. In the first case, he suggested that organic compounds had a carbon skeleton with other atoms connected to the remaining carbon bonds. This proposal correctly describes many classes of organic compounds. The idea was completely empirical but it gave a starting point for describing the thousands of organic compounds known at the time. In addition, the carbon skeleton with various function groups attached, starts to give an explanation for the variety of properties seen in organic compounds. For example, all alcohols have an oxygen between a hydrogen and a carbon while all ethers have an oxygen between two carbons. The second great contribution of Kekulé was a proposed structure for benzene which had the unusual formula of C_6H_6 . Benzene, and related compounds, had unusual properties such as distinctive smells. For this reason, they had been called aromatic (aroma producing) compounds. Aromatic compounds are much more reactive than simple hydrocarbons (containing only hydrogen and carbon) like butane (C_4H_{10}).

Louis Pasteur (1822–1895) was also a friend and supporter of Laurent. Laurent suggested to Pasteur that he study the salts of tartaric acid to determine their properties, especially their optical activity. (Certain compounds rotate polarized light.) Pasteur observed that half the crystals were oriented in an angle to the right and the other half to the left. He also found that they rotated light accordingly and that mixtures that did not rotate light were equal mixtures of the two forms.

In the 100 years, from the late 18th century to the late 19th, chemistry had become a science and made remarkable progress. Following Dalton, all knew there must be a mechanism to *chemical bonding*, that is, to what held the atoms together.

At the same time, another great cosmological barrier loomed, the Vitalist theory that separated *organic* from *inorganic* chemistry, terms we still use today. Wöhler, in a purposeful search to synthesize a natural product succeeded and only the dogmatists could continue to claim that a part of nature could be created only by the gods and that *spirit* was required for *assimilation* of inorganic into organic materials.

In 1839, Salicylic acid (*aspirin*, the first wonder drug) was extracted from the leaves of the spirea plant. Ultimately the German chemist George Bayer patented aspirin, the first wonder drug, in 1889.

Spurred on by a growing major economic frontier, the chemical industry, the 19th century was to know hundreds of thousands of new compounds synthesized in the laboratory by organic chemists. And, theories of bonding, which would both explain and predict chemical compounds and properties, were sought. Again, the empirical and theoretical thinking brought logical models which would be the mainstay of chemical understanding.

It would be in the 20th century, with first the discovery of subatomic particles (particularly the electron) and later the development of quantum mechanics that chemists would have our modern theories of chemical bonding. Two American chemists, who both spent most of their careers in California, G.N. Lewis and Linus Pauling would be the central figures in the development of bonding theory. Pauling's *The Nature of the Chemical Bond and the Structure of Molecules and Crystals* (1939) is a comprehensive treatise on early theories of chemical bonding. We will discuss chemical bonding in Chapter 16.

If Newton stood on the shoulders of giants, then, he, along with Descartes, Galileo and others, gave birth to numerous more giants who would push back the frontier of the molecule and the structure of all material, living and non-living, of which the universe is made.

.....Alcatel-Lucent 

www.alcatel-lucent.com/careers

What if you could build your future and create the future?

One generation's transformation is the next's status quo. In the near future, people may soon think it's strange that devices ever had to be "plugged in." To obtain that status, there needs to be "The Shift".



7 Classical Electricity, Magnetism and Light (1700–1900)

During the Enlightenment and the hundred years that followed it, while chemistry was becoming a science, Newtonianism and the scientific method made progress in understanding and utilizing electricity and magnetism. These developments also advanced our understanding of light. And the physics of electricity was important to understanding chemistry.

With the help of the great mathematicians, Euler, Lagrange, and Laplace, Newton's laws became deeply entrenched in the 19th century. Newtonianism became the dominant paradigm. The great French mathematician and astronomer **Pierre-Simon Laplace** (1749–1827) postulated the mechanical Universe based on Newton's laws. Laplace believed that if you knew the position and momentum of every particle in the universe, you would be able to calculate all the future positions and momentums. i.e. Laplace believed that physics had shown the universe to be totally determined and operate like a machine. (Quantum mechanics would later prove Laplace wrong but his was a very attractive idea to scientists.)

A dramatic confirmation of Newton's laws was the discovery of the planet Neptune in 1846. William Herschel had discovered the seventh planet, Uranus, in 1781. Astronomers calculated Uranus' orbit using Newton's laws of motion and gravitation as outlined in the *Principia*. But, when Uranus' orbit was actually observed and carefully measured, it fit the Newtonian predictions—with the exception of a slight wobble about 1.5 minutes of arc in twenty years. Could there be errors in observation? Could there be errors in calculation? Or, could there be another reason?

Simultaneously in 1845, two theoretical astronomers, Urbain Le Verrier in France and John Couch Adams in England, used Newton's laws to calculate the position and size of a new planet beyond Uranus that could cause such an aberration. Adams' supervisor lacked confidence in the calculations, so they were not published. Le Verrier, who had published his calculations, asked the German astronomer Johann Galle to look for a new planet at given coordinates in the sky. On the very evening that he received Le Verrier's instructions, September 23, 1846, Galle looked and discovered Neptune. (In retrospect, it turned out that Adams had not only anticipated the discovery, but that the English on three occasions had actually observed the planet but had not known it!) Newton's laws work remarkably well and Pluto was discovered in 1930 using similar calculations on the orbit of Neptune.

In the 19th Century science tried to achieve a unified theory of physical phenomena. “We are near a complete understanding of physical phenomena.” One physicist remarked. “Particles of matter in motion, governed by forces, strictly determined, and expressed in mathematical formalism.” Many thought that astronomy had proven Laplace's *Mechanical Universe*!

At the beginning of the industrial age, electricity, magnetism, heat, and light were mysteries. Although the 19th century did not achieve a unified mechanical-mathematical theory, it laid the foundations for electro-magnetism, thermodynamics and kinetics, and wave theory of light. Newton (and Descartes) believed that the material world was made up of particles. Dalton's atomic theory confirmed that the elements indeed were comprised of atoms and molecules. But science still did not understand the principle of cohesion. And electricity and heat seemed to behave like fluids, not like particles.

7.1 Electrical Phenomena

William Gilbert (1544–1603), court physician to Queen Elizabeth I studied the properties of magnetism. He concluded that the Earth was a gigantic magnet with north and south poles. He also believed that magnetism had something to do with holding the universe together.

Benjamin Franklin (1706–1790) demonstrated that lightning and electrical effects were the same. The Leyden jar, which could store an electrical charge, had been invented in 1745 by Pieter van Musschenbroek. (Today the Leyden jar is called a capacitor or condenser.) Until this time, experiments with electricity could only be done by producing sparks and any kind of quantification of electrical effects was not possible. With the Leyden jar, however, it was possible to store a charge and use it later. (See Link 7.1.)

Link 7.1 Leyden Jar

<http://bit.ly/14UvczE>

There is uncertainty about whether Franklin actually conducted his kite experiment. It was logical to think that lightning might just be static electricity on a large scale. (In fact, the Ancient Greeks had speculated this.) The sparks created by rubbing different materials together certainly look like small lightning bolts and they give shocks and can even start fires like lightning bolts.

Franklin speculated that large amounts of electrical charge were generated in storm clouds. This again was logical as lightning results from storm clouds once they are mature. What is known for sure about Franklin's experiment was that he later wrote that he flew a kite, with a silk string and with a key on the string connected, by wire, to a Leyden jar, into growing storm clouds. The Leyden jar built up a large electrical charge during the experiment.

It is unlikely that lightning actually hit the kite because Franklin would have likely been killed. However, the friction in rapidly moving clouds builds an electrical charge and the experiment as described would have worked. Many pilots have heard static buildups on their radios as they flew through storm clouds and numerous airplanes have been hit by lightning. Franklin's experiment was crucial to the characterization of electricity.

Luigi Galvani (1737–1798) was an Italian physician who lived in Bologna. Around 1773 he was dissecting a frog on a bench where he was also conducting electrical experiments. A scalpel touched to a severed leg of a frog created sparks and caused the muscle to contract and leg to kick. Presumably, the scalpel had picked up a charge from other items on the bench.

Galvani concluded that *animal electricity* was produced by the frog and carried by the muscle to the nerve causing the reflex. Galvani promoted the idea that all life was electrical. A life-long argument as to the source of electricity developed between Galvani and the next individual in our story. The argument was advanced through their publications and lectures and those of their students and associates.

Galvani's protagonist was **Count Alessandro Volta** (1745–1827). Volta first studied chemistry and then became a professor of physics at the Royal School at Como, Italy. His knowledge of both disciplines served him well. Among his discoveries is the important chemical compound methane (CH_4). He developed the law of capacitance that shows that voltage and charge are proportion in a given capacitor.



Join the best at
the Maastricht University
School of Business and
Economics!

Top master's programmes

- 33rd place Financial Times worldwide ranking: MSc International Business
- 1st place: MSc International Business
- 1st place: MSc Financial Economics
- 2nd place: MSc Management of Learning
- 2nd place: MSc Economics
- 2nd place: MSc Econometrics and Operations Research
- 2nd place: MSc Global Supply Chain Management and Change

Sources: Keuzegids Master ranking 2013; Elsevier 'Beste Studies' ranking 2012; Financial Times Global Masters in Management ranking 2012

Maastricht University is the best specialist university in the Netherlands (Elsevier)

Visit us and find out why we are the best!
Master's Open Day: 22 February 2014

www.mastersopenday.nl



Click on the ad to read more

In 1791 Volta studied Galvani's *animal electricity* and found that he could replace the frog's leg with a salt-soaked piece of paper between two different metals and generate an electrical current. Volta concluded that the frog's leg was a conductor of electricity, not the generator. In 1800, Volta made his greatest contribution by the invention of the Voltaic pile, a series of two different metals separated by brine solutions. He used zinc and silver to construct a Voltaic Pile, what we now call a *battery*. (A battery is a series of a electrochemical cells although it has become common to call even a single cell a battery.) (See Link 7.2.)

Link 7.2 Voltaic Pile (Battery)

<http://bit.ly/14hzy8l>

By placing alternately silver and zinc metal sheets, separated by paper wetted with brine (salt water solution), Volta generated a large electrical current that could be used for quantitative experiments. A single cell (one sheet of silver and one of zinc separated by paper wetted with brine) produces a current by itself. However, the force of this current, which will come to be called its voltage, is increased with a series of cells.

Volta's battery gave scientists, for the first time, a constant and reproducible source of electric current. It was now possible to study electricity in a reproducible and quantitative fashion. Within a decade of Volta's invention, both electrolysis and electroplating were discovered. We will say more about the former soon.

We wanted to discuss Galvani and Volta together because their competing theories about the production of electricity were crucial to many developments. Simply put, Galvani thought electricity was produced by animals (organically) and Volta thought it was produced by inorganic materials. The irony, of course, is that they were both right. Electric currents are produced by electrochemical cells and biological cells themselves often have electrochemical properties. These properties are essential to the functioning of nervous systems.

In between the times of the two Italians' great discoveries, another scientist, this time French, made one of the most fundamental discoveries about electricity. In the 1780s, **Charles de Coulomb** (1736–1806) quantified electric charge. Coulomb invented the torsion balance which allowed much smaller quantities of force to be measured accurately. (See Link 7.3.) (An English geologist, John Michell also had made a torsion balance about 1750.)

Link 7.3 Coulomb's Torsion Balance

<http://bit.ly/1cZr8Im>

It was known that opposite charges attracted each other and like charges repelled each other. Coulomb was able to determine the mathematical relationship between charge and force to be:

$$F = -q_1 q_2 K / r^2 \text{ where } q = \text{charge, } K \text{ is a constant, and } r = \text{distance}$$

The force, whether attractive or repulsive, decreases with the square of the distance between the two charges. This relationship bears a remarkable similarity to Newton's Law of Gravity:

$$F = m_1 m_2 G / r^2 \text{ where } m = \text{charge, } G \text{ is a constant, and } r = \text{distance}$$

At this point in history, science knew of two forces and both varied proportionally to a property of the objects (mass or charge) and inversely proportionally to the square of the distance between the two objects. With Coulomb's law it was possible to apply mechanics to charged bodies in the same way that Newton's law allowed the application of mechanics to massive bodies.

Two other important events in developing an understanding of electricity and magnetism should be mentioned. In 1817, Andre Ampere, a French physicist, discovered that parallel electrified wires in which the current ran in the same direction repelled one another. Also, in 1821, Hans Christian Orsted, a Danish chemist and physicist, electrified a platinum wire causing it to glow. More importantly, the needle of a near-by compass focused on the wire as if it were a magnet. Orsted determined that the electrified wire was surrounded by a magnetic effect. Orsted devised the galvanometer, which is essentially a compass with a bent needle to measure magnetic deflection caused by an electrical current. The galvanometer became an important device for accurately measuring current. (See Link 7.4.)

Link 7.4 Galvanometer

<http://www.tpub.com/neets/book16/33NP0033.GIF>

Electricity was magnetic. Was the opposite true? We will see shortly that Orsted's discovery led to other, very important developments.

7.2 Volta's Cell Applied to Chemistry

The same year that Volta's cell was announced (1800), a British civil engineer passed an electric current through water producing hydrogen at the cathode (negative electrode) and oxygen at the anode (positive electrode). This reversal of the well-known process of making water from hydrogen and oxygen added important evidence in support of Dalton's atomic theory that would be announced only three years later. (See Link 7.5.)

Link 7.5 Electrolysis of Water

<http://www.instructables.com/id/Separate-Hydrogen-and-Oxygen-from-Water-Through-El/>

When two electrodes are placed in water, and a voltage is applied across them, water is broken up into hydrogen and oxygen. Oxygen gas bubbles up from the positive electrode and hydrogen gas bubbles up from the negative electrode. The terms positive and negative were arbitrarily assigned. However, researchers realized that the charges were opposite so the terms positive/negative are appropriate

In addition, both Sir **Humphry Davy** (1778–1829), one of England's most distinguished chemists, and the great Berzelius in Sweden used electrolysis to isolate various elements. Many elements such as sodium and fluorine were isolated for the first time by electrolysis.



Empowering People. Improving Business.

BI Norwegian Business School is one of Europe's largest business schools welcoming more than 20,000 students. Our programmes provide a stimulating and multi-cultural learning environment with an international outlook ultimately providing students with professional skills to meet the increasing needs of businesses.

BI offers four different two-year, full-time Master of Science (MSc) programmes that are taught entirely in English and have been designed to provide professional skills to meet the increasing need of businesses. The MSc programmes provide a stimulating and multi-cultural learning environment to give you the best platform to launch into your career.

- MSc in Business
- MSc in Financial Economics
- MSc in Strategic Marketing Management
- MSc in Leadership and Organisational Psychology

BI NORWEGIAN BUSINESS SCHOOL

EFMD **EQUIS** ACCREDITED

www.bi.edu/master

Berzelius believed that electricity was the force that held atoms together to form molecules. This would explain why some atoms would be attracted to the positive electrode and others to the negative electrode. If atoms were oppositely charged, then these atoms should bond together as do oxygen and hydrogen and many other pairs.

7.3 Electricity, Magnetism and Light

Michael Faraday (1791–1867) was perhaps the greatest experimentalist of the 19th century. Faraday's life is a rags-to-riches story. He had little education, and a notorious aversion to mathematics. Faraday was the son of a blacksmith. His family was too poor to keep him in school so at 13 he became an errand boy for a bookstore. The owner apprenticed Faraday as a bookbinder (a term of seven years) for books that came into the shop.

Faraday not only learned to bind books, but he also read everything that came his way, including the Encyclopedia Britannica. While still working at the bookstore, he attended the lectures of Sir Humphry Davy, built his own Voltaic pile, and independently discovered electrolysis by running current through solutions of silver nitrate, copper sulfate, and aluminum chloride, noting that the metals were deposited on the negative electrode.

Faraday sent Davy a report on his own scientific experiments, and a copy of Davy's own lectures finely bound. Davy wondered what to do about Faraday and asked the advice of one of the Governors of the Royal Institution of Great Britain, of which he was Director. The Governor advised: "Let him wash bottles! If he is any good, he will accept the work; if he refuses, he is not good for anything."

Faraday accepted and remained at the Royal Institution for 45 years, first as Davy's assistant, then as his collaborator, and eventually as Director. Despite his general ignorance of mathematics, Faraday had remarkable skill in envisioning how nature worked. As Davy's apprentice, he showed great skill, intuition and creativity.

Davy and Faraday repeated both Orsted's and Ampere's experiments. Faraday pressed on, and conducted two experiments that may seem obvious and simple today, but which required great ingenuity.

In 1821, Faraday designed a remarkable experiment that became the basis for the electric motor. A permanent magnet was set in a bowl of mercury. A battery was connected to the mercury and also to a wire suspended above the bowl and just touching the mercury. (See Link 7.6.) When the current was applied, the hanging wire rotated around the fixed magnet.

Link 7.6 Original Faraday Electric Motor

<http://www.sparkmuseum.com/MOTORS.HTM>

In 1831, Faraday conducted a set of electrical and magnetic experiments. He passed a magnet through a coil and generated an electric current. (See Link 7.7.)

Link 7.7 Magnet Generating Current in Coil

<http://bit.ly/12nrOjX>

When the magnet stops moving, the current stops as well. By this experiment, Faraday had proven that mechanical motion could be converted into an electric current.

Likewise, when Faraday passed an electric current through a coil, it generated a magnetic field that attracted an iron bar. (See Link 7.8.)

Link 7.8 Current Generating Magnetic Field

<http://bit.ly/13EifA>

When the current stops, the iron bar stops moving as well. Faraday had proven that an electric current could be converted into mechanical motion. This is the basis of all electric motors.

Faraday had invented both the electric motor and the electric generator. Others, primarily Joseph Henry, an American Scientist who was the first Secretary of the Smithsonian Institution, improved and developed the electric motor and generator into practical devices. The Industrial Revolution would now move from steam to electricity as its driving force. Electricity had great advantages. For example, electricity could be moved over great distances by wires and it could be switched on and off conveniently. (See Link 7.9.)

Link 7.9 Electrical Switch

http://www.123rf.com/photo_264323_vintage-electrical-switch.html

It was quickly learned that metals conduct electricity and most other materials do not. So, switches were made by simply screwing two metal clips to a block of wood and connecting a metal strip to one of the clips. With wires connected to the clips, when the flexible strip is pushed against the contact, the current flows. When the flexible strip is released, and allowed to break the connection, the current doesn't flow.

Later, Faraday wrapped iron rings with copper wire and determined that he could create an electrical induction from a charged ring to the uncharged ring. Thus the transformer was invented. By analogy to the mechanical advantage of levers and gears, transformers could change the voltage of an electric current by having different numbers of turns in the two coils. (See Link 7.10.)

Need help with your dissertation?

Get in-depth feedback & advice from experts in your topic area. Find out what you can do to improve the quality of your dissertation!

Get Help Now



Go to www.helpmyassignment.co.uk for more info



Helpmyassignment



Click on the ad to read more

Link 7.10 One Coil Generating Current in Another

<http://en.wikipedia.org/wiki/Transformer>

The voltage ratio between the two coils is the ratio of the number of turns in each coil. In other words, if the first coil has 50 turns and the second coil 100 turns, when 5 volts are passed through the first coil, a 10 volts is generated in the second coil. (This does not, however, mean that you are getting something for free. While the voltage is doubled in the second coil, the current produced is only half and the actual energy, which is proportional to the product of voltage and current, remains the same.)

Finally, Faraday determined that electricity and magnetism were virtually identical in his famous, but elegantly simple experiment, of passing a magnet through one of his electrical coils. Faraday determined that it did not make any difference whether the magnet was moved or whether the coil was moved: either action produced an electrical current. Of this famous experiment, Faraday wrote: “The mutual relation of electricity, magnetism, and motion may be represented by three lines at right angles to each other, any one of which may represent any one of these points and the other two lines the other points. Then if electricity be determined in one line and motion in the other, magnetism will be developed in the third; or if electricity be determined in one line and magnetism in another, motion will occur in the third. Or if magnetism be determined first then motion will produce electricity or electricity motion. Or if motion be the first point determined, magnetism will evolve electricity or electricity magnetism.”²³

In Faraday’s own words is the heart of the theory and practice of electromagnetism. From these principles, one can in effect create an electric motor. And also from these principles came the development of the dynamo, or generator, which powers our electric civilization.

Faraday did not know it at the time, but he had just taken the first step towards Einstein’s theory of relativity. We have already discussed ordinary, mechanical relativity known to Galileo and Newton. Faraday had discovered a new relativity. Electricity at rest (at least relative to the observer) is called static electricity. Electricity that is moving (relative to the observer) is called current. Faraday determined that the electromagnetic phenomena were the consequence of relative motion of the apparatus – not the absolute motion of any part. That is, the same electromagnetic effect was achieved whether one moved the magnet up and down in the coil, or moved the coil up and down over the magnet. It made no difference. But, the amount of current that was produced was dependent on the relative speed of the magnet and coil to each other. An observer sitting at a galvanometer has no way to tell how the equipment is moving – there is no absolute state of rest that can be measured to tell us whether the magnet or the coil is moving – all he can observe is that they are moving relative to one another!

Place the magnet and coil in a car, train, or airplane, and there is no way to determine the absolute speed that the vehicle and its electrical equipment are moving. Again, only the relative motion of magnet and coil can be determined in a speeding vehicle. Faraday was intrigued by the discovery that absolute motion cannot be determined by electromagnetic experiments – only relative motion can.

Faraday was much more than a clever inventor and experimenter, however. He was also a brilliant theorist. As we have already stated, electricity raised questions about corpuscular or particle theory. Electricity seemed to behave like a fluid affecting an area or field rather than a particular point or place. When a drop of water hits the rug, it spreads out to form a wet area. The drop loses its particular identity, while the area or field becomes continuously damp. The basic elements of matter (in this case our drop of water) are discrete or they are continuous in nature – they cannot be both at the same time.

Faraday did not question the particular or atomistic theories being developed by Dalton and Berzelius at this same time, but he believed that particular matter influenced other matter through the action of the imponderables. Further, Faraday proposed that the imponderables – electricity, magnetism, gravity, and light – were continuous entities that occupied fields in space and time.

Faraday began with the famous experiment of the magnet, bits of iron filings, and paper, that demonstrates the effect of a magnetic field of force. Once again, we have the problem of explaining action at a distance. Faraday asked, what is more fundamental: the action of the iron filings, or the *lines of force* that appear to be aligning them? (See Link 7.11.)

Link 7.11 Lines of Force

<http://www.ribbonfarm.com/wp-content/uploads/2007/10/magnet0873.png>

Faraday believed the lines of force were more fundamental – without the lines of force, there would not be a magnet. Faraday no doubt believed the force field was the basic entity. And he believed that magnetic force fields and electric force fields were related to one another in some way.

It was evident to Faraday that the magnetic force field caused the iron filings to align according to the lines of force. But what about the force field itself? Did it occupy space, or did it change space? Here we have the first questioning of Newton's idea of absolute space. Did electrical or magnetic force fields affect space itself?

If space is not bending or curving as a consequence of electromagnetic effects, then what is? In what medium do the electromagnetic phenomena occur? Faraday's only alternative was to propose that the force fields acted in an electromagnetic aether.

After Faraday concluded that an electrical field was equivalent to a magnetic field *in motion*, he speculated that his electromagnetic force fields might be similar to Newton's gravitational force fields. Thus Faraday spent the last years of his life trying to work out a *unified general field theory* that would reconcile the imponderables electricity, magnetism, and gravity. Faraday was puzzled by a problem that continues unresolved. If electromagnetic fields of force are interchangeable with gravitational fields of force, why is it that electromagnetic forces are both attractive and repulsive, but gravity as experienced in nature is only attractive?

Faraday thought that Newton's theory of gravitational action-at-a-distance was incompatible with his theory of the continuous force field of electromagnetism. To understand Newton better, Faraday studied Newton's mathematical calculations, and concluded that it was Newton's calculations that made gravitational theory appear to be valid.

In addition to his brilliance as an experimentalist and theoretician, Michael Faraday was noted for his excellence as a lecturer. He was famous for explaining difficult concepts to school children. Whenever it was announced that Faraday would lecture at the Royal Institution, both Charles Darwin and Charles Dickens always came. Dickens even encouraged Faraday to write popular books on science.

An advertisement for SKF. The background is a blue-tinted image of a woman with long dark hair smiling, with a wind turbine behind her. The text is overlaid on the image.

Brain power

By 2020, wind could provide one-tenth of our planet's electricity needs. Already today, SKF's innovative know-how is crucial to running a large proportion of the world's wind turbines.

Up to 25 % of the generating costs relate to maintenance. These can be reduced dramatically thanks to our systems for on-line condition monitoring and automatic lubrication. We help make it more economical to create cleaner, cheaper energy out of thin air.

By sharing our experience, expertise, and creativity, industries can boost performance beyond expectations. Therefore we need the best employees who can meet this challenge!

The Power of Knowledge Engineering

Plug into The Power of Knowledge Engineering.
Visit us at www.skf.com/knowledge

SKF

James Clerk Maxwell (1831–1879) lived only 48 years, but along with Faraday produced some of the most brilliant physics of the 19th century. Maxwell has two claims to fame: first, he founded the Cavendish Laboratory at the Cambridge University, which became one of the leading laboratories for atomic and nuclear physics; and second, he developed the mathematical synthesis for establishing electromagnetic theory.

Maxwell, a Scot, was virtually the antithesis of Faraday. Maxwell was from a wealthy family, he was a mathematical prodigy, and enjoyed the best of education and contacts.

Maxwell's great contribution was to take Coulomb's electrostatic work, Faraday's electromagnetic theory, Gauss' study of magnetism, and Ampere's research, reduce each to comparable equations, and then produce synthetic equations which were equivalent for electrical fields and magnetic fields. Mathematicians immediately recognized that Maxwell's equations were variations of the *standard wave equation* – whether it is water waves or sound waves. In other words, Maxwell's equations stated that there was a new kind of wave involving electrical and magnetic fields – this would later be known as electromagnetic waves. (See Link 7.12.)

Link 7.12 Electromagnetic Wave

<http://bit.ly/181QIV0>

As the figure shows, the electric and magnetic fields are at right angles to one another and at right angles to the direction of propagation of the waves – just as Faraday had described. But Maxwell discovered more!

In 1849, Armand Hippolyte Fizeau (and later in 1862 Jean Foucault) calculated the velocity of light using similar devices. The experimental apparatus took advantage of interference patterns. By passing beams of light through moving water, with one beam going in the direction of the water flow and the other going against the water flow, the resultant interference pattern can be used to calculate the speed of light. (See Link 7.13.)

Link 7.13 Measurement of Speed of Light

[http://commons.wikimedia.org/wiki/File:Speed_of_light_\(Fizeau\).PNG](http://commons.wikimedia.org/wiki/File:Speed_of_light_(Fizeau).PNG)

Later, in 1887, using a similar apparatus, Michelson and Morely determined that light had a constant speed in a vacuum. We will return to this when we discuss Einstein's Special Relativity.

More importantly, earlier in the century, Thomas Young and Augustin Fresnel independently developed theory and experimentation which demonstrated the wave theory of light, in conflict with Newtonian hypothesis of the corpuscular nature of light. All of the imponderables now seemed to moving along on waves: heat, light, electricity, and magnetism. (In the next section we will discuss heat.)

Maxwell, then, not only established the wave theory of electromagnetism, but he also predicted that electromagnetic waves would propagate at the speed of light. Maxwell concluded: “The velocity of transverse undulations...agrees so exactly with the velocity of light...that we can scarcely avoid the inference that light consists in the transverse undulations of the same medium which is the cause of electric and magnetic phenomena.”²⁴

Obviously, we are approaching a unified field theory based on the propagation of electromagnetic and light waves through some sort of aetherial substance.

7.4 Electrical Technology

The development of electrical technology provides an excellent case study of the relationship between science and technology, engineering and industry, in which science leads the way in theory, observation, and experimentation. The work of Faraday, Maxwell, and others, established a firm foundation for electrical technology.

Of course, the age of steam was well underway by this time, as was gas lighting in streets, homes, and factories. By 1825, over 50 English towns were lit by gas.

In his early experiments concerning induction, Faraday determined that electricity not only had a positive and negative aspect, but that it also could be switched *on* and *off*. This *on-off* aspect of electricity obviously could be incorporated into communications. The first application of this principle was the invention of the telegraph in 1837 used for railway signaling. With the development of the Morse code and cables laid under the English Channel in 1850, and across the Atlantic in 1866, a world-wide communications revolution was underway. In 1844 Samuel Morse, tapped out the first telegraphic message from Washington, DC to Baltimore, “What Hath God wrought.”²⁵ The telegraph aided governments, armies, and businesses. The telegraph allowed instant communications between customers and stock markets, and inflamed public imagination about the progress of technology. (See Link 7.14.)

Link 7.14 On/Off Switch and Telegraph

<http://bit.ly/17322TZ>

Using an On/Off Switch a magnetized coil could be used to move a metal rod against a plate at the other end of a wire creating a signaling device. The telegraph was first used on railroads for signaling when railroad track switches had to have their positions changed. It was, however, only a short time before communications were sent by telegraph. Such instant communications over a long distance creating a brand-new world of commerce.

Maxwell wrote to Faraday in 1857: “You are the first person in whom the idea of bodies acting at a distance by throwing the surrounding medium into a state of constraint has arisen...your lines of force can weave a web across the sky and lead the stars in their courses without any necessary immediate connection with the objects of their attraction.”²⁶ How prophetic.

TURN TO THE EXPERTS FOR **SUBSCRIPTION** CONSULTANCY

Subscribe is one of the leading companies in Europe when it comes to innovation and business development within subscription businesses.

We innovate new subscription business models or improve existing ones. We do business reviews of existing subscription businesses and we develop acquisition and retention strategies.

**Learn more at [linkedin.com/company/subscribe](https://www.linkedin.com/company/subscribe) or contact
Managing Director Morten Suhr Hansen at mha@subscribe.dk**

SUBSCR✓**BE** - to the future



In 1886–88, Heinrich Hertz in Karlsruhe, Germany succeeded in producing and directing Faraday's and Maxwell's invisible electromagnetic waves across space, just as Maxwell had predicted. Using a simple apparatus (an electrical oscillator and a spark detector), Hertz produced electromagnetic waves, which today we know as radio and TV broadcast waves. The electromagnetic waves that Hertz produced travelled at the speed of light, just as Maxwell predicted, and had all the properties of Maxwell's equations. Hertz, like Maxwell, died young, and Marconi and others perfected the technology that led to wireless and radio communication. (See Link 7.15.)

Link 7.15 Hertz Apparatus

http://www.sparkmuseum.com/BOOK_HERTZ.HTM

The most significant economic use of electrical power, however, was in the development of electric motors and dynamos. Early battery powered electric motors were technically sound, but hopelessly outclassed by steam engines. After Faraday's discovery of the principle of the generator (dynamo), however, large scale use of electrical power became possible. Electricity did not become economically competitive with steam until after Edison invented the incandescent filament light bulb in the 1870s. Electric lights provided the economic basis for the growth of the electrical industry.

In 1882, New York and London built central power stations, with dynamos driven by steam. Berlin's power station began operation in 1888. By the 1890s electric lighting was quickly displacing gas lighting. Concurrently, in the late 1880s and 1890s, electric trams and electric railways began operation in the cities. In 1890, London opened its first underground *tube line*, which is still in operation today as part of the Inner Circle. Electricity was produced at Niagara Falls in 1896.

As we have seen, the electrical industry was dependent on scientific progress. The same was not the case for steam technology, which provided power for mills, factories, and the railroads. We will explore steam technology and thermodynamics in the next chapter.

8 Thermodynamics (1700–1900)

8.1 The Rise of Steam Technology

In the previous chapter, we saw an example in electricity and magnetism where scientific discovery led to technological application. In the case of heat (and steam), the technological development came first and the scientific discovery followed.

You will recall that Lavoisier thought that heat was a substance, which was very far from a valid explanation. Steam engines were built and applied without any basic science to support them. This did not, however, stop the Industrial Revolution from changing the world.

You will recall that ordinary pumps, which worked by removing air from the top of a pipe and letting the air pressure on the water force it upwards, could only lift water about 30 feet. One of the first steam engines was built in 1698 by Thomas Savery who used the steam pressure developed in an iron boiler to help pump water from mines. Savery's steam pump could raise water about 150 feet. Because mines were being dug deeper and deeper in search of coal and metal ores, Savery's steam pump was an important invention.

Thomas Newcomen developed an improved steam pump in 1712, safer because it employed a piston and did not depend on high pressure steam which often caused accidents. By 1769, James Watt improved the Newcomen steam engine, increasing the efficiency three-fold. Watt's new and efficient source of constant power attracted mill owners who had been dependent on the flow of streams turning water wheels for power. By the time of the American Revolution, Watt and his partners were manufacturing about 20 industrial steam engines a year. (See Figures 8.1 and 8.2.)

Link 8.1 Newcomen Steam Engine

http://en.wikipedia.org/wiki/Thomas_Newcomen

Link 8.2 Watt Steam Engine

<http://www.humanthermodynamics.com/watt-engine.jpg>

Steam engine efficiency increased so dramatically that by the time of the American Civil War in 1861, steam engines were applied to manufacturing and transportation in the form of trains and railroads and ships. The Industrial Revolution was powered by steam.

The best known early American adaptation of steam technology was Robert Fulton's steam boat, which in 1807 cut travel time between New York City and Albany (about 150 miles) from more than four days to 32 hours. (See Link 8.3.)

Link 8.3 Fulton Steam Boat

<http://bit.ly/176lwFj>

By the 1840s coal had replaced wood as the primary fuel. 1815–1860 has been called the *golden age* for steamboats in the United States. For the most part, the advance of western industrialization was an economic revolution driven by new technologies, not by innovations in basic sciences.

8.2 Heat and Energy – the First Law of Thermodynamics

Of course, scientists were interested in the scientific basis for the new steam technology. But the nature of heat was not understood until the 19th century. Galileo and others tried to measure or quantify heat. Modern thermometers and measuring schemes were developed by the 18th century.



What do you want to do?

No matter what you want out of your future career, an employer with a broad range of operations in a load of countries will always be the ticket. Working within the Volvo Group means more than 100,000 friends and colleagues in more than 185 countries all over the world. We offer graduates great career opportunities – check out the Career section at our web site www.volvogroup.com. We look forward to getting to know you!

VOLVO
AB Volvo (publ)
www.volvogroup.com

VOLVO TRUCKS | RENAULT TRUCKS | MACK TRUCKS | VOLVO BUSES | VOLVO CONSTRUCTION EQUIPMENT | VOLVO PENTA | VOLVO AERO | VOLVO IT
VOLVO FINANCIAL SERVICES | VOLVO 3P | VOLVO POWERTRAIN | VOLVO PARTS | VOLVO TECHNOLOGY | VOLVO LOGISTICS | BUSINESS AREA ASIA

In 1714, German Daniel Gabriel Fahrenheit invented the mercury thermometer and the Fahrenheit temperature scale. In 1742, a Swedish astronomer, Anders Celsius, developed the Centigrade or Celsius scale of temperature that ultimately replaced the Fahrenheit scale everywhere but in the U.S. The Celsius scale is based on water: 0 degrees is defined as the temperature at which water freezes and 100 degrees as the temperature at which water boils. (Today's scientists use another scale: 0 degrees Kelvin equals absolute zero, the lowest possible temperature. Kelvin degrees are the same as Celsius degrees so you can add 273.15 to the Celsius temperature to get Kelvin. We will discuss the determination of absolute zero later in this chapter.) It is not coincidental that Celsius based his scale on water since heat was believed to be an imponderable fluid. (See Link 8.4.)

Link 8.4 Fahrenheit vs. Celsius

<http://www.fahrenheit.org/>

On the Fahrenheit scale the freezing point of water is defined as 32 °F and the boiling point of water as 212 °F. On the Celsius the freezing point of water is defined as 0 °C and the boiling point of water as 100 °C. The two scales are compared on the graph above. Each can be converted to the other by using the following formulas: $F^{\circ} = (9/5) \times C^{\circ} + 32$; and $C^{\circ} = (F^{\circ} - 32) \times (5/9)$.

You will recall that Lavoisier coined the term *caloric* to distinguish heat from Aristotle's *fire* which was not a basic constituent of matter. It was also noted by Lavoisier that heat, like light, did not have weight, but appeared to flow in and around matter. The *calorie* (Latin, *calor*, heat) is defined as the amount of heat required to raise the temperature of 1 gram of water 1 degree Celsius. (The calorie content of foods is actually given in units of kilocalories, that is, the amount of heat required to raise 1 kilogram of water 1 degree Celsius.)

Like other sciences, much of the early study of heat was descriptive and qualitative. Radiant heat, for example, seemed to possess many of the same qualities as light, and early experiments by William Herschel and others, suggested that heat and light might be explained by a common theory. This was *before* heat was regarded as a form of energy. Before 1820, physicists still held to Newton's particle theory of light and heat was also thought to be comprised of particles, rather than motion – suggesting, of course, that something particulate was *hot*.

The equivalency of heat and energy was first suggested by **Benjamin Thompson** (1753–1814), Count Rumford. (Thompson was a colonial turn-coat who ultimately fought for the British in the American Revolutionary War.) Watching cannons being bored in Munich, Rumford noted how hot the metal became. Buckets of water were poured on the metal to cool it during the boring process. The standard explanation would be that the boring action had liberated the *caloric fluid* in the metal. Rumford concluded, however, that the heat was the consequence of work produced by the motion of the boring apparatus. (See Link 8.5.)

Link 8.5 Cannon Barrel Boring

<http://www.clemson.edu/caah/history/facultypages/PamMack/lec122sts/inve>

[tion6.html](#)In the 1840s, Englishman **James Prescott Joule** (1818–1889) established that mechanical work could be converted into heat quantitatively. In a number of careful experiments (the paddle wheel being the most famous), Joule determined that work converted to heat at a definite, measurable rate of conversion, i.e., 4.2 Joule equal 1 calorie. (See Link 8.6.)

Link 8.6 Joule Experiment

http://etc.usf.edu/clipart/35600/35657/joule_35657_lg.gif

Joule also determined that an electrical current passed through a certain resistance gave a specific amount of heat. Joule is credited with the discovery of the First Law of Thermodynamics: $\Delta E = H + W$ where: ΔE is the change of energy in a system, H is the heat added to the system, and W is the work done on the system. Obviously any of these parameters can be negative. For example, when the system cools H is negative and when the system does work on the surroundings W is negative.

The First Law of Thermodynamics is another way of stating the Law of Conservation of Energy. Historically, the problem of heat played a major role in the development of the Law of Conservation of Energy. Gravitational energy and kinetic energy were obviously related, but the idea of heat as energy was not quite so obvious. Conservation of Energy is another way of saying: *You can't get something for nothing*. (Many *perpetual motion* machines attempt to produce energy by some scheme such as water flowing downhill through a turbine-generator that turns an electric motor that powers a pump to pump the water back up into the reservoir.) (See Link 8.7.)

Link 8.7 Perpetual Motion Machine

<http://bit.ly/1d3NMOZ>

A German physician, **Julius Robert Mayer** (1814–1878) is generally credited as the first scientist to propose that all natural forces (electricity, magnetism, gravity, heat, mechanical work, etc.) are equivalent. Mayer suggested that the term *force* was vague and ambivalent, and he proposed using the term *energy*, instead. Mayer, and later Hermann von Helmholtz, saw that all forces – animal heat and mechanical work – were convertible, yet conserved.

From the perspective of physiology, Mayer perceived that all forms of energy are equivalent, meaning that energy can be transformed from one form to another providing that the total amount of energy remains constant.

In 1848, Scottish physicist **William Thompson** (1824–1907), who would become Lord Kelvin, arrived at a fascinating conclusion based upon Charles's Law of Gases. Charles's Law states that the volume of a gas is directly proportional to its temperature. Joseph Louis Gay-Lussac published this relationship in 1802 based upon unpublished work of Jacques Charles from around 1787.

gaiTEYE
Challenge the way we run

EXPERIENCE THE POWER OF
FULL ENGAGEMENT...

.....

RUN FASTER.
RUN LONGER..
RUN EASIER...

READ MORE & PRE-ORDER TODAY
WWW.GAITEYE.COM

Thompson had observed that gases expand or contract about $1/273^{\text{rd}}$ of their volume for each 1 degree (Celsius) temperature change around 0°C . Thompson extrapolated the volume to zero at -273°C . He concluded that -273°C must be the lowest possible temperature. Kelvin's absolute zero became the basis for the Kelvin temperature scale. Many chemical properties are a function of the absolute temperature. Kelvin's value was amazingly accurate for the crude apparatus of the 19th century. (The current value for absolute zero is -273.15°C . On the Kelvin scale, the freezing point of water is 273.15K and the boiling point is 373.15K .) (See Link 8.8.)

Link 8.8 Extrapolation to Absolute Zero

<http://bit.ly/1d3NPKy>

By plotting the volume of a gas in ordinary temperature ranges, and then extrapolating the temperature lower, Kelvin realized that the data predicted the gas would have zero volume at -273°C . Of course, zero volume would make no sense but it did suggest to Kelvin that there was a lower limit to temperature.

Joule, as we have already discussed, also saw the relationship between heat and work. And so it followed that there is a relationship between energy and work. The First Law of Thermodynamics is a special case that applies to the transformation of heat to mechanical work. Joule put Mayer's theory on a firm foundation of physical theory. Energy is the capacity to do work. The study of heat and work became known as *thermodynamics*. (In *thermodynamics*, *thermo* refers to heat, and *dynamics* refers to motion or work.)

The Law of Conservation of Energy brought a sense of unity concerning physical forces in nature, but it also set limits to the age of the Universe. According to the Law of Conservation of Energy, the sun cannot create energy out of nothing. Consequently, the sun cannot continue to shine forever, radiating heat and light into the solar system. The sun is a finite system with a limited amount of energy.

In 1863 Lord Kelvin, based on the Law of the Conservation of Energy, estimated that the sun could not be more than 100 million years old. Consequently, the Earth could not be more than 100 million years old. A number of physicists tried to lengthen the age of the sun by suggesting that its energy was regularly supplemented by meteors crashing into the sun. But Kelvin rather easily deflected these arguments.

Kelvin's calculations created a serious crisis for the uniformitarianism school of geology, and inferentially, for Darwinism as we will discuss later. There was not enough time for geological or biological evolution. In addition, the idea that the sun itself has finite life, scientifically raised a point that religions had always addressed: that there were limited supplies of energy in the solar system, and that the universe itself was mortal.

Lord Kelvin's recognition that the sun had a limited lifetime was a very important 19th century insight. But his actual estimate of the lifetime of the sun was much too low because he did not know about nuclear energy, which increased the life of the sun by a large factor. (Instead of 100 million years the sun is actually about 4.5 billion years old. This age will allow enough time for uniformitarianism and evolution. In Chapter 19 we will discuss how the age of the Earth and sun are determined.) Nevertheless, Kelvin's insight still stands – the sun has not always shined, and will one day *burn out*.

8.2 Entropy – The Second Law of Thermodynamics

The First Law of Thermodynamics (conservation of energy) raises an important question about the universe. If energy is conserved, why does your soup grow cold, or your ice cream melt? Why does smoke fill the room, but never gather in a corner? Why do ice cubes placed in warm water melt cooling the water? Why doesn't the resulting solution ever turn into ice and warm water. More profoundly, why does nature's time flow *forward*, but never *backward*?

Sadi Carnot (1796–1832), a French army officer, began to contemplate such questions in 1824 as he thought about James Watt's steam engine. Carnot realized that the essential principle of the steam engine was the temperature differential created between the steam boiler and cooling condenser. Carnot made an analogy between the steam engine and the common water wheel. Falling water produced work in the waterwheel, falling temperature produced work in the steam engine.

By the Law of Conservation of Energy, of course, heat transferred to work is energy conserved. Carnot noted that the principles of the steam engine were little understood, and in a brilliant thought experiment he worked out the theoretical maximum efficiency of one of Watt's steam engines.

$$\text{Efficiency} = \frac{T_H - T_C}{T_H} \times 100\%$$

where T_H is the temperature (in Kelvin units) of the hot body and T_C is the temperature of the cold body. Notice that 100% efficiency can only be achieved if the temperature of the cold body is absolute zero.

In a frictionless, reversible engine (like a water wheel) wouldn't heat be ideally conserved? Envisioning such a frictionless, reversible engine, Carnot placed similar engines side by side in his thoughts – one of them slightly more efficient than the other. In Carnot's mind, the more efficient machine drove the other machine in a reverse cycle. Because the first engine was more efficient, however, that engine would also produce some useful work.

Carnot had just imagined a perpetual motion machine which he realized was an impossibility! But he died of cholera before he could fully work out the answer to this question. And after the fashion of his time, most of his papers were burned so that little was left for him to contribute to the history of science. But his ideas provided important insight into what would become known as the Second Law of Thermodynamics.

What was wrong then, with Carnot's frictionless engine models? **Rudolf Clausius** (1822–1888) in Germany provided the answer. Carnot's heat flow was sound; Joule's idea that heat was converted to energy was sound; what had to be given up was the idea of the conservation of heat. Energy, Clausius realized, is conserved, but some heat is converted to work and some passes to a lower state.

This e-book
is made with
SetaPDF



SETASIGN

PDF components for PHP developers

www.setasign.com



What Clausius established is that certain natural processes flow in one direction, and *only in one direction*. From hot to cold, but not from cold to hot. This universal tendency he called *Entropy*, which is the basis for the Second Law of Thermodynamics. Said Clausius: “We can express the fundamental laws of the universe which correspond to the two fundamental laws of the mechanical theory of heat in the following simple form: 1. The energy of the universe is constant. 2. The entropy of the universe tends towards a maximum.”²⁷

Entropy is associated with an increase in disorder in a system. Order and disorder are defined relative to the degree of probability of states in a system. A highly improbable configuration is highly ordered. A highly probable configuration is highly disordered. Because isolated systems evolve in the direction of a more probable configuration, they naturally become more disordered with time. Thus entropy increases.

A good example would be shuffling a deck of cards. There are many combinations with red and black cards in mixed order but far fewer combinations with all the red cards ahead of all the black cards. When we shuffle a deck it is very unlikely that all 26 red cards will precede all 26 black cards.

Consider two gases in neighboring containers. When you open the door between them, the gases become intimately mixed. Thus, disorder, or entropy, increases. Maxwell, who we met in the previous chapter, developed the mathematics of thermodynamics with thought experiments of his own. The most famous of Maxwell’s thought experiments involves a hypothetical demon. (Maxwell’s demon seems to provide a constant source of energy with no source! The fallacy in Maxwell’s proposition was not discovered until the 20th century.)

Maxwell, along with the Austrian physicist **Ludwig Boltzmann** (1844–1906), developed a kinetic theory of gases and went on to invent statistical thermodynamics. In some ways, it is easier to understand the concept of entropy thinking statistically. (See Link 8.9.)

Link 8.9 Gas Molecules in Box with Partition

<http://bit.ly/1dqNO1X>

In part c of the figure two gases, A (blue) and B (red), are placed in the two chambers of a container with a wall between. Temperature and pressure are maintained the same in both containers. When the wall is removed, in a short period of time there is a mixture of both gases in each chamber. This natural mixing, which increases the disorder of the container, is called *entropy*.

Consider the mixing of two gases as we described above. After the door is opened between the two containers, each molecule moves freely about the entire area. Let's work out the case of three molecules (A, B, and C) distributing themselves between the two containers (1 and 2). The following table gives all the possible arrangements of the three molecules in the two containers.

<u>Container 1</u>	<u>Container 2</u>	<u>Number in 1</u>	<u>Number in 2</u>
ABC		3	0
AB	C	2	1
AC	B	2	1
A	BC	1	2
BC	A	2	1
B	AC	1	2
C	AB	1	2
	ABC	0	3

The total number of configurations is 8. The number of configurations with 3 molecules in one container and zero in the other is 2. The number of configurations with 2 in one container and 1 in the other is 6. Since the molecules move freely around the two containers, the probability at any time that all the molecules will be in one or the other container is $2/8 = 1/4$ or 25%. The probability that two molecules will be in one container and one in the other container is $6/8 = 75%$. Clearly the more disordered state of 2 molecules in one container and one in the other is the higher entropy and most likely state.

Expanding to 4 molecules gives 16 possible states. There will be 2 configurations of 4, 0; 8 configurations of 3, 1; and 6 configurations of 2, 2. Now the probability of all molecules being in one container is only $2/16$ or 12.5%. Statistical mechanics and statistical thermodynamics works well with molecules because the numbers are so large under most circumstances. For example, a liter (slightly more than a quart) of a gas at standard temperature and pressure contains about 3×10^{22} molecules. (10^{22} is ten thousand billion billion!)

Maxwell died of stomach cancer in 1879 at the age of 48. Boltzmann continued to make important contributions in theoretical physics but had bitter disputes with other scientists of the era. Thinking himself a failure, he committed suicide in 1906 at the age of 62. At his request, Boltzmann's gravestone contains the equation for entropy as derived by statistical thermodynamics: $s = k \log W$ where s is entropy, k is a constant and W is the number of microscopic states.

8.3 Entropy and Civilization

Perhaps the oldest idea in western civilization is the idea of an eternal, static, and unchanging universe. We discussed this idea first in relationship to the Greeks, especially Aristotle. If humans and the world were mortal, at least the heavens, filled mostly with divine aether, were eternal.

Copernicus demoted the Earth from the center of creation, but the creation itself still enjoyed divine perfection. Of course, because of friction in the system, Newton, a deist, had seen that from time to time God would have to give creation a *kick-in-the-pants* to keep the world from running down.

By the 19th century, scientists were no longer confident that God would so graciously intervene to wind up the clock again. Lord Kelvin and others began to talk gloomily about the *heat death* of the universe.

As we have discussed, energy can be converted to work only if there is a temperature difference. Because the Second of Thermodynamics inexorably moves to equalize all temperatures, at some point a closed system will have the same temperature throughout and will be incapable of doing work. In the end, all closed systems are supposed to suffer such a heat death.

Free eBook on Learning & Development

By the Chief Learning Officer of McKinsey

[Download Now](#)

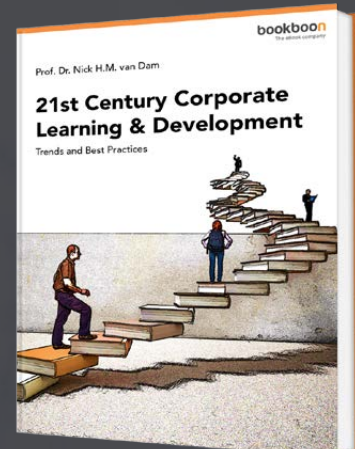

[Click on the ad to read more](#)

Will the universe, all life, civilization, and purpose then end in a whimper? In 1862, Lord Kelvin, one of the discoverers of the Second Law of Thermodynamics, rejected the idea that the universe would suffer a heat death. Lord Kelvin wrote that “it is impossible to conceive of a limit to the extent of matter in the universe; and therefore science points to endless progress...[rather] than to a single finite mechanism, running down like a clock, and stopping forever.”²⁸

Others were not as optimistic as Lord Kelvin, and the Second Law of Thermodynamics, with its pessimistic forecast of inevitable disorder and heat death of the universe, inspired dread and dismay among many 19th century intellectuals who once optimistically celebrated the idea of progress.

Entropy introduced a new sense of *time* in western science and civilization. Never before had Europeans had the sense of time running out. We all have a sense of finitude, of course, but the Second Law of Thermodynamics forced western society to think about the end of time itself. Could one continue to believe in Newton’s Absolute Time, if entropy extinguished time?

One other, very important, cosmological concept that arises from the Second Law is that if the universe must have an end, then it must have had a beginning. The fact that the universe has not yet reached its temperature equilibrium, to which it continues to progress, means that the universe cannot have existed forever. This will be important as we move to the cosmology of the 20th century.

In concluding this part of our discussion on thermodynamics, we should add that the 20th century will give us the Third Law of Thermodynamics: a perfect crystal at absolute zero would have zero entropy. This law gives a reference, or starting point, for entropy.

Pessimistically we can describe the three laws of thermodynamics as follows:

- 1st Law $\Delta E = H + W$ (You can’t get something for nothing.)
- 2nd Law $\Delta S = \int q/T$ (You can’t even break even.)
- 3rd Law $\Delta S = 0$ (perfect crystal at 0 K) (You can’t quit the game.)

9 Natural History – Taxonomy and Geology (1700–1800)

9.1 Foundations of Natural History

From Ancient Greece until well into the 18th century, natural philosophy (not biology) placed all animals and plants along the Great Chain of Being. Starting with the simplest plants, you trace plants up the Great Chain to animals, and eventually to humans. Aristotle classified animals into red-blooded and non-red-blooded animals, and viviparous (live-bearing) from egg laying animals. In general, the Greeks (e.g. Aristotle) were much better at gross anatomy than physiology. That is, they would observe and describe structures much better than biological functions.

Galen and Hippocrates had both emphasized observation, and Galen particularly emphasized dissection. Galen left behind a copious, coherent, comprehensive, and largely accurate body of work but with some major problems. He thought that the lungs provided *cooling air* that was carried to the heart by the *arterial vein*. The action of the heart itself was a *push-pull* action.

Galen had dominated anatomy and physiology for 1500 years. His shortcomings, of course, were well known, especially in the medical schools in Italy that had grown up with the Renaissance. In the medical schools, the physicians would read from Galen, while surgeons cut the cadaver. (Surgeons/barbers were from a lower class—they were like technicians and helpers, not well respected.) Sometimes they blamed the translation or the surgeon, but not Galen. It was Andreas Vesalius who actually challenged Galen.

Andreas Vesalius (1514–1564), the founder of modern anatomical science published his great book *De Humani Corporis Fabrica* (On the Construction of the Human Body) in 1543, the same year that Copernicus published *De Revolutionibus*.

Vesalius as a young man was professor of medicine at the great University of Padua. He received a regular consignment of corpses of executed criminals from the Padua court, and made great progress in the study of anatomy. Unlike the bombastic Paracelsus, Vesalius, cautiously, politely, but firmly, corrected Galen's anatomy.

Although *De Fabrica* did not win over the entire medical community, Vesalius' descriptions, accompanied by wonderful illustrations drawn by a student of Titian (the great Renaissance artist), steadily won over the students in Italian medical schools in Padua and Bologna. (See Link 9.1.)

Link 9.1 From De Fabrica

<http://vesalius.northwestern.edu/>

Vesalius' insisted that physicians and students do their own dissections. It was imperative, he argued, that every medical student make their own observations and discoveries. With Vesalius as Europe's leading anatomist, Padua's fame was such that it attracted students from all over Europe, including Englishman.

William Harvey (1578–1657) was an unlikely scientific rebel. He admired Aristotle and Galen. Harvey graduated from Cambridge and then studied medicine at the University of Padua, from 1600–1602. (Galileo was on the faculty.) He returned to England for another medical degree at Cambridge and then went into practice. Harvey became royal physician to King James, and continued as physician to Charles I, remaining with the King during the English Civil War.

At Padua, Harvey studied with Hieronymus Fabricius, discoverer of the valves in the veins. Fabricius concluded that the valves prevented blood from falling in the lower extremities. About the same time, anatomists at Padua discovered the *lesser circulation* between the heart and the lungs by identifying the pulmonary artery.

But anatomy was learned from cadavers whose organs were not functioning. Back in England, Harvey had the good fortune of observing the laborious beating of a dying heart. He realized that the heart was not beating push-pull-push-pull as Galen supposed, but was beating push-rest-push-rest (systole-diastole)!

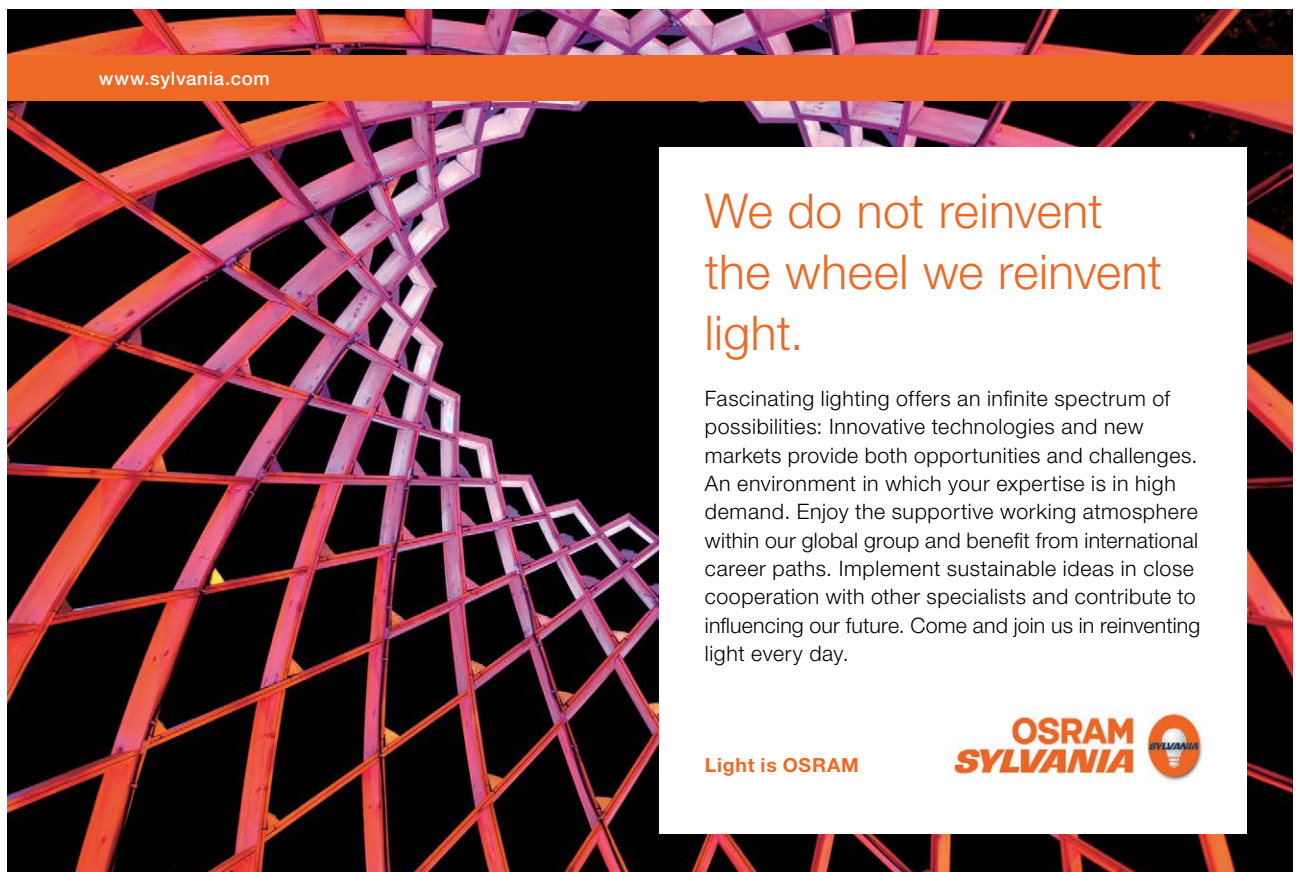

www.sylvania.com

We do not reinvent the wheel we reinvent light.

Fascinating lighting offers an infinite spectrum of possibilities: Innovative technologies and new markets provide both opportunities and challenges. An environment in which your expertise is in high demand. Enjoy the supportive working atmosphere within our global group and benefit from international career paths. Implement sustainable ideas in close cooperation with other specialists and contribute to influencing our future. Come and join us in reinventing light every day.

Light is OSRAM

OSRAM SYLVANIA 

Harvey observed that the heart was working with the mechanical motion of a pump, like pushing water through a pipe. The function of the valves in the veins was also clear, it was to return the blood to the heart. Harvey envisioned a mechanical hydraulic system for general circulation of blood in the body. He described the circulatory system as a large mechanical system of pipes and valves connected to a pump, the heart. He still did not know about capillaries, which weren't discovered by Marcello Malpighi until 1661 – shortly after Harvey's death. (Malpighi found the capillaries using a microscope.) Harvey published *An Anatomical Study of the Motion of the Heart and of the Blood in Animals* in 1628. (See Link 9.2.)

Link 9.2 Harvey's Blood Circulation

<http://bit.ly/13PVOCy>

Harvey made three contributions: 1) He advanced medicine and life science on a firm basis of direct observation and experimentation. 2) He introduced quantitative reasoning in the study of anatomy and physiology. Harvey's mechanical model could be diagrammed and measured. Harvey calculated that the heart pumped about 400 pints of blood through the aorta in 24 hours. He estimated that the normal body had about 10 pounds of blood and the heart pumped about this much in a little over ½ hour. Galen thought that blood was manufactured by either the heart or the liver but the body could not possibly manufacture 400 pints of blood each day. 3) Most important was Harvey's discovery of the circulatory system. He created a single circulatory system with a single center (the heart) to replace the multiple systems of Galen. His achievement can be compared to Copernicus, Kepler, and Galileo. However, his modern theories cost him many patients.

Note: While medicine advanced little in the West during the dark ages, it rose to considerable heights among the Arabs. In the 13th century, Ibn al-Nafis of Damascus, while living and working in Egypt, advanced the theory of pulmonary circulation. Some of Al-Nafis's work was translated into Latin in 1547. It is not clear whether Padua had this information at the time of Harvey's tenure there. Nonetheless, Harvey stands as a giant among medical scientists for observing and then promoting the theory of blood circulation.

James Ussher (1581–1656), Archbishop of Armagh, was Vice-Chancellor of Trinity College in Dublin (protestant). The 16th and 17th century Europe suffered an *information overload*. Newly discovered animals, plants, and peoples, raised questions about the creation story and the subsequent Great Flood as mentioned in the Bible.

Where did all this extra creation come from and how did it fit into Holy Scriptures and the Great Chain of Being? Was the creation story in the Bible incomplete? Had God made mistakes? Was the process of creation still continuing? Did the apparent disorder of nature contradict the rational mechanical Newtonian system?

The new discoveries were not necessarily contradictory to Scriptures. Christianity is principally a religion about human history, but it also had much to say about natural history – especially the age of the Earth.

In 1650, Ussher, Archbishop of Armagh and Primate of All Ireland, calculated the age of Earth tracing backwards through the chronology of the Bible which he supplemented with other sources. Ussher published *Annals of the Old Testament, Deduced from the First Origins of the World* in 1650. Ussher believed he could precisely date creation at October 23, 4004 BCE, making the Earth less than 6000 years old. Ussher's calculation became part of the authorized English Bible in 1701 and remained there until 1950. (See Link 9.3.)

Link 9.3 Authorized English Bible showing Age of Earth

http://christianity.wikia.com/wiki/Dating_creation

Ussher did not comment about natural or geological history – but the implications of his date for the age of the Earth were very important. All changes in God's creation, either in animal species or geology, would have had to occur very rapidly over a narrow time frame. The rise of mountain ranges would have to have been incredibly violent and quick.

Notice that Ussher, the opposite of being a fundamentalist, wanted to show that Irish institutions also had great scholars. His use of the Bible to calculate the age of the Earth was a scholarly process itself. However, this raises the fundamental question as to whether the Bible is a history book. The rise of modern geology, and then evolutionary biology, dramatically challenged Ussher's assumption.

Biology is an artifact of the 19th century. But the first major attempt to bring order and system out of the vast biological data collected since the time of Columbus was initiated by the great Swedish naturalist and taxonomist, **Carolus Linnaeus** (Carl von Linne) (1707–1778), a collector of birds and plants.

Linnaeus, a professor at the University of Upsala, was determined to bring order out of apparent chaos. He developed a classification system for all plants and animals based upon the determination of their *genus* and *species*. Linnaeus classified plants and animals according to their *similarity*, taking especial note of their reproductive systems. In his system, human beings are classified as: Phylum – Chordata; Subphylum – vertebrata; Class – Mammalia; Order – Primates; Family – Hominidae; Genus – Homo; Species – sapiens. Hence we are called *Homo sapiens*. (Notice, DNA had not been discovered so, of course, DNA testing was not possible. Many changes are being made in the classification scheme now.) (See Link 9.4.)

Link 9.4 Linnaean Classification

<http://bit.ly/14ZaWE1>

Linnaeus believed the natural world to be ordered and systematic. He held to ideas of plenitude, gradation, continuity, and especially, immutability. Linnaeus did not initially believe that species had evolved or that any had become extinct.



Discover the truth at www.deloitte.ca/careers

Deloitte.

© Deloitte & Touche LLP and affiliated entities.



Click on the ad to read more

Linnaeus' work was first published in 1735 as an eleven page work titled *Systema Naturae, the System of Nature*. By the 10th edition in 1758 it included more than 4000 species of animals and more than 7000 species of plants. Linnaeus believed the *System* was a recapitulation of God's creation. He believed that all species could be traced back to an original pair created by God. By cataloging all the species, Linnaeus envisioned himself as a Second Adam renaming God's creation. Linnaeus liked to say: *Deus creavit; Linnaeus disposuit*. God created; Linnaeus organized.

Linnaeus believed his *System* reflected God's thoughts. He noted the differences between wild and domesticated animals, and believed domestication was only *temporary*. Linnaeus' created an herbarium and zoo which collected all the known species (4,200 animal species). He wanted to recreate the time of *Creation*, make a new Garden of Eden.

Linnaeus made several contributions to natural philosophy, including his classification of humans as *Homo sapiens*. Despite the fact that his classification system was based on the premise of the immutability of the species, it remains the standard for taxonomy today.

But Linnaeus did wonder about plant hybridization and whether everything had been created at the beginning. He wondered if they might be *the work of time*.

William Paley (1743–1805) was a philosopher and church functionary. Linnaean biological classification was blessed in Paley's *Natural Theology* (1802). According to Paley order and symmetry in nature reflected God's design. Paley was famous for: *Everything was in its place and there was a place for everything*.

Paley believed that God's creative hand was observed in every organism. It was Paley who offered the watchmaker analogy. (If you came upon a watch in the woods lying on the ground, would you believe someone made it or that it happened by accident?) The exquisite order of nature argued for God.

According to Paley, the most exquisite design of God was the human eye. The eye was the ultimate manifestation that humans had been created in the *image of God*.

Paley believed he had found the answer to the ethical dilemma of the Enlightenment. How is it possible to determine ethical and moral imperatives from the Laws of Nature? Paley stated that Natural Order was ordained by God. That which promoted Natural Order was in harmony with God's will. That which disrupted God's Natural Order was evil. That which upset harmony was sin. Here was the key to moral education. Moral education devised ethics and morals from those actions that promoted, secured, or maintained Natural Order (or Natural Law). This is an example of the *vocabulary* of the Newtonian culture being used to defend conservative social philosophy.

George Louis Leclerc, **Comte de Buffon** (1707–1788), was one of the most catholic scholars of the Enlightenment. He was educated in mathematics and physics and influenced by Newton. Buffon served as keeper of the *Jardin du Roi* (The King's Gardens) in Paris.

Buffon envisioned himself the *Newton of Natural Philosophy*, and attempted to fashion a comprehensive description of the natural world which unified Newtonian cosmology and mechanics with observations of the natural world, including animals, plants, minerals, geography, climate, and so forth.

For more than 35 years (1749–1785), Buffon labored on his massive (36 volume) *Histoire Naturelle*, which rivaled the *Encyclopedie* in its comprehensive and vivid description of the incredible diversity of nature.

Buffon was impressed with the great diversity in the natural world, but he discerned less order and regularity in Nature than did Linnaeus. Buffon argued that Linnaeus' system did not replicate the mind of God, but rather reflected the imagination of Linnaeus.

Buffon believed that organisms had a history, a *Natural History*. Over time, one could not only discover similarities, but also one had to account for variation. Buffon knew about the fossil record and recent discoveries. Hottentots were discovered at the end of the 17th century in South Africa and were thought by some to be missing link between humans and apes. In 1739, biologist Trembley discovered the *Hydra*, a fresh water polyp which was widely viewed as the missing link between plants and animals.

Buffon postulated his own historical Great Chain of Being leading from ancient slime to humanity. Buffon did not directly challenge the Creation story presented in the Bible, but he certainly elongated it. In order to integrate Newtonian cosmology with Earth history, Buffon needed more than the 6000 years allowed by Ussher.

In 1755, Immanuel Kant proposed that the solar system had formed from matter separated from the sun. Buffon liked this idea because it seemed to fit nicely with Newtonian cosmology. Was it possible, Buffon asked, for the Earth and solar system to have formed from a giant explosion caused when a comet crashed into the sun?

Ingeniously, Buffon melted some iron balls and waited so see how long it took for them to cool to the touch, which was several days. Then extrapolating from his data, Buffon calculated how long it would take an iron ball the size of the Earth to cool sufficiently to support life. He came up with a figure of about 74,000 years. And he thought that the time could be a great deal longer.

How could Buffon reconcile what he had found with the Creation story about how God created the Earth in six days? Buffon reasoned that the six days of creation described in the Bible did not necessarily mean six 24-hour days. Rather, Buffon speculated that the Earth had been created in vast *Epochs*, each characterized by God's creative purpose.

Thus, as the Earth gradually cooled into the modern Epoch and life forms evolved from the primordial slime into modern species. Buffon does not really develop a modern theory of evolution, but his theory did challenge the static, timeless, ahistorical biology of Linnaeus and Paley with a dynamic Earth history that would lay the initial groundwork for Darwin's *On the Origin of Species*.

9.2 Natural History and Classical Geology

The early history of geology is complex. In the 18th and 19th centuries Geology became one of the most popular of the sciences, and scores of professional and amateur geologists were engaged in exploring and describing local rocks and geological formations. Thomas Jefferson's *Notes on Virginia* remains one of the best accounts of early American geography and geology. Bones of woolly mammoths and saber tooth tigers were first discovered in North America, and then the bones of dinosaurs were discovered and identified in Europe. How did extinct animals fit into the economy of God's creation?

People thought of Earth history as conforming to the Bible; that there was a creation moment and a Garden of Eden. The Earth was about 6000 years old according to Bishop Ussher, and there had been a Great Flood. The Flood dominated the story of the development of the Earth. Carrying the Bible story further, the Earth had been perfect and spherical in the days of the Garden of Eden. It was the introduction of sin by man that caused the imperfections in the Earth that we see today.

SIMPLY CLEVER

ŠKODA



We will turn your CV into
an opportunity of a lifetime

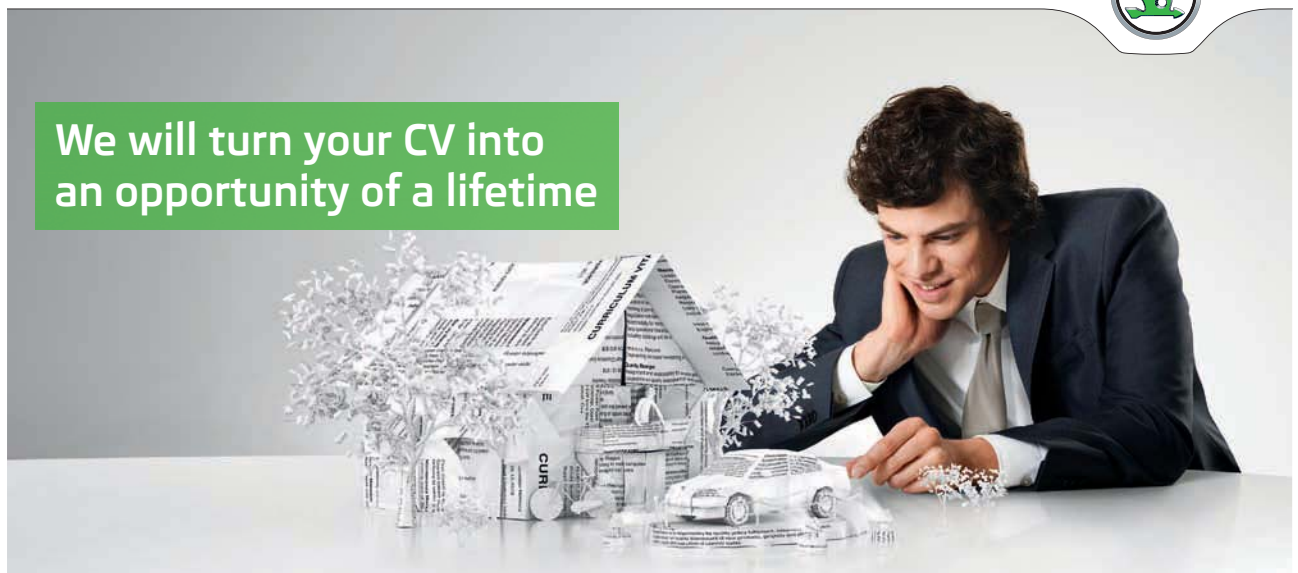

Do you like cars? Would you like to be a part of a successful brand?
We will appreciate and reward both your enthusiasm and talent.
Send us your CV. You will be surprised where it can take you.

Send us your CV on
www.employerforlife.com



Click on the ad to read more

But, reconciling geological evidence to scripture proved a major stumbling block to the elucidation of Earth history. In 1691, Thomas Burnet offered classic diluvia theory interpretation. (*Diluvia* means produced by a flood.) The surface of the Earth between the time of the Garden of Eden and the Great Flood had been regular and smooth – God’s perfect creation. But human sin had required God to cleanse the Earth with a Great Flood. The Great Flood accounted for the geological irregularities of the Earth. In sum, the Earth had degenerated from its original perfection as a consequence of human sin. Floods, storms, earthquakes, and natural disasters indicated further *groaning* of the creation under the weight of sin.

Serious interest in Earth history and geology began in Italy about the time that Newton graduated from Cambridge University. Canal building in northern Italy dramatically exposed rock strata.

Nicholas Steno (1638–1686) was a Dane who renounced Lutheranism and ultimately became a Bishop in Northern Italy. Steno noted that fossilized shark teeth (dog-fish) were imbedded in the strata. Some would say the teeth confirmed the scriptural account of the Great Flood. (See Link 9.5.)

Link 9.5 Strata with Fossils

<http://www.gutenberg.org/files/20417/20417-h/images/image158.jpg>

Steno’s observations certainly did not contradict scripture. But Steno reasoned that the shark’s teeth imbedded in the rock, suggested that the rock had been soft mud at the time the teeth had been deposited. Thus he concluded that the strata were not all created at the same time, but laid down successively, one layer upon the other. And, of course, there was not just a solitary stratum with shark’s teeth, but others with bones and other life-like impressions. Steno concluded that he was observing an historical record which could not be explained by a single Great Deluge.

By the 18th century – the Age of the Enlightenment – with the sophisticated development of canal building and mining, engineers had accumulated a great deal of information regarding the structure and composition of European geology. And from observers such as Thomas Jefferson, they received information about the new world.

Since Steno and Newton, questions about the basic forces that had shaped the Earth itself became important. One did not have to reject Thomas Burnet’s doctrine that the Great Flood had shaped with Earth, but the theory of a single great flood was not sufficient to explain all geological change. Even Burnet had calculated there was not enough water in the oceans to cover all the Earth assuming that it was possible to rain in a universal deluge for 40 days and nights and had had to assume that subterranean waters had burst to the surface! (Newton had also done this calculation. If you use the data we have today, you will find it would require two and one-half times all the water on Earth to cover the entire surface of the Earth. Remember, even Mount Everest would have been submerged!)

What forces, then had shaped the Earth? Of Aristotle's elements, was it primarily water, the Great Flood, rain, rivers, the oceans? Or was it fire: volcanoes, great hot forces from within the Earth? How long was the Earth's history? Had the Earth shaping forces always been the same? Were the Earth shaping forces constant? Or was the Earth shaped in catastrophic, creative moments? Was the Earth itself subject to Newton's mechanical laws?

Abraham Werner (1749–1817) was the first modern geologist to develop a systematic, comprehensive theory of geology. Werner was a professor of mineralogy at one of Germany's best known mining schools at Freiburg. Werner has been called the Linnaeus of Rocks. He undertook a typically 18th century project à la Linnaeus, the *Encyclopedie*, and Buffon – he set out to create a comprehensive catalogue of rocks – their locations, descriptions, compositions, and of course, their names.

By all accounts, Werner was a marvelous, master teacher. He was beloved by his students, who were fiercely loyal disciples who carried Werner's geological theories across Europe, forming Wernerian Societies wherever they settled. Werner was a spell-binding lecturer. Give him a rock, any rock, and Werner could not only tell you what it was, where it could be found, and what were its economical uses, if any, but he conjured up wonderful images of Hannibal's legions, or of Genghis Kahn, or the Great Caesar striding across the landscape from which the rock was obtained.

Werner believed that geology provided a literal foundation for all civilization and culture. From a single stone, he would wax eloquently on the progress of the arts, languages, religion, industry and economy, wars, and education of the region in which the rock was found. For Werner, geology was literally the solid rock on which the liberal arts were founded.

Not only were his lectures colorful and inspiring, but Werner also explained the origin of all the rocks that made up the Earth. Werner's theory was twofold: the Earth was once enveloped by a universal ocean; and the rock strata that make up the Earth's crust were precipitates or sediments from that ocean. Key to Werner's theory was that he believed granite had been the first of the rock strata to have been precipitated out of a great ocean soup. In other words, he did not believe that granite was of igneous or volcanic origin.

Werner taught that the rock strata had been laid down in five great epochs during which the oceans covered the land, beginning with granites and ending with clays and sands. Subsequently, living species, fish, mammals, and human appeared, roughly in the order described in the Bible. The Noah's Flood could have been the last of the universal floods. (See Table 9.1.)

Primitive	Igneous rocks – first precipitates from the ocean before the emergence of land
Transition	Limestones, dikes, sills, and thick sequences of greywakes
Secondary	Remaining stratified fossiliferous rocks – emergence of mountains
Alluvial	Sands, gravels and clays
Volcanic	Younger lava flows

Table 9.1: Werner's Great Epochs

Werner was the founder of the *Neptunist* theory of the origins of the rocks. According to Werner and his followers, volcanic activity was both relatively recent, and of only local consequence. Volcanic activity played no role in shaping the Earth's geological activity as a whole.

But the Neptunist theory had its problems; not the least of which was what had happened to all the water that once covered the entire globe? The need to explain the ebb and flow of vast oceans of water would prove a major problem in the Neptunist theory.

The major challenger to Werner's system came from **James Hutton** (1726–1797), an extra-ordinary Scottish *gentleman* geologist. Hutton attended Edinburgh University where he first studied law, and then tiring of law, returned to study medicine. He practiced medicine for a while, and then retired to become a farmer.

e-learning for kids

- The number 1 MOOC for Primary Education
- Free Digital Learning for Children 5-12
- 15 Million Children Reached

About e-Learning for Kids Established in 2004, e-Learning for Kids is a global nonprofit foundation dedicated to fun and free learning on the Internet for children ages 5 - 12 with courses in math, science, language arts, computers, health and environmental skills. Since 2005, more than 15 million children in over 190 countries have benefitted from eLessons provided by EFK! An all-volunteer staff consists of education and e-learning experts and business professionals from around the world committed to making difference. eLearning for Kids is actively seeking funding, volunteers, sponsors and courseware developers; get involved! For more information, please visit www.e-learningforkids.org.

Chemistry was Hutton's hobby, and led him to his first challenge of Werner's theory. Observing outcrops of granite on his own land, Hutton examined the crystalline nature of granite and concluded that it was igneous in origin, having been formed under great heat and pressure. Further examination, led him to the conclusion that volcanic forces had indeed played a significant role in shaping the Earth's crust.

Hutton determined that Scotland's mountains were chiefly of igneous origin, not sedimentary. Elsewhere he found evidence of granites overlying older sedimentary layers. In some areas of Scotland, the granite appeared to be the youngest rock, not the oldest. Hutton knew, of course, that if granite turned out to be of volcanic origin, Werner's whole Neptunian system would collapse.

In some of the literature, Hutton and his followers have been called *Vulcanists*, or *Plutoists*, in order to distinguish them sharply from Wernerian Neptunists. Hutton distinguished between igneous and sedimentary rocks, and then (unlike Werner) he described a class of rocks that were sedimentary in origin, but had been transformed under great heat and pressure. (See Link 9.6.)

Link 9.6 Volcanism

<http://pubs.usgs.gov/of/2004/1007/images/volcanic.gif>

In his book *Theory of the Earth* (1795), Hutton summarized his doctrine of *uniformitarianism*. To understand geological forces, Hutton argued, we must begin by studying the present forces which are shaping the Earth. He assumed that the forces which are at work today, were the forces that were at work in the past, and will be at work in the future. This is what he meant by uniformitarianism. The natural geological forces at work shaping the Earth are uniform over time and space.

Motion, or change, then is constant—the Earth is never at rest. Hutton envisioned a continuing process of building up and wearing down. Land was always being formed and reformed. Hutton's major handicap was that his scheme required too much time. (See Link 9.7.) Again, the problem of the age of the Earth arises.

Link 9.7 Uniformitarianism

<http://uniformitarianism.tumblr.com/post/7734877967/cathedral-peakyosemite-california>

Hutton's uniformitarianism vision was not only hard to grasp, but was breathtaking in its larger implications. How did sea bottoms become mountain tops? How did fire and water interact to shape the Earth? How old was the Earth? What was the nature of geological time? Was anything fixed or permanent?

The answer to some of these questions would be found in *stratigraphy*, the mapping of geological strata, and the interpretation of the evidence from fossils. Fossils were known from ancient times. Fossils, especially mollusks, looked like animals, but had hardness, and other characteristics of rocks.

The major challenge was the discovery of marine fossils on high ground, and especially in the mountains. For some, the marine fossils discovered in the mountains, confirmed the Biblical story of the flood. Others speculated that pilgrims had dropped the shells on their way to Rome (or wherever). And still others, Voltaire, for example, went so far as to argue that the fossils were not really the remains of animals, but were simply rocks.

In *Notes on Virginia*, Thomas Jefferson speculated on the reports that fossil clams had been found high in the Andes Mountains of South America. Jefferson did not think much of the Pilgrim theory, nor did he take Voltaire's argument seriously. Of the two alternatives that Jefferson thought were plausible: the oceans once covered the mountains or the mountains once formed the seabed. He rejected Werner's theory that the seas had once covered the Andes Mountains.

Jefferson knew of no geological forces that could raise up mountains. As a good Baconian, Jefferson suspended judgment.

William Smith (1769–1839), a contemporary of Jefferson, was an engineer and canal builder in England. It was Smith who first recognized the true historical significance of the rock strata. Around the turn of the 19th century in England, the industrial revolution was taking off. It was the industrial revolution that supported the first development of mass transportation. Canals were built, to some degree, to haul farm products to market and passengers, but mostly to haul vast amounts of coal from the mines to the burgeoning factories and industrial cities in the English Midlands.

While engaged in the canal building trade, William Smith became an expert on the rock strata of all Great Britain. He realized that one could map all of England according to the rock strata that ran across the country – some 19 strata from London to Wales and Scotland. Smith made a geological map – the first of its kind – that helped him locate useful building material as well as coal seams. (See Link 9.8.)

Link 9.8 Stratigraphic Map

<http://bit.ly/186kYhG>

Smith was also the first to perceive that there was a relationship between certain fossils and particular strata – and he used this relationship to identify the strata as they appeared in outcrops across the landscape. Smith’s book *A Definition of the Strata of England and Wales, with part of Scotland* (1815), is now one of the classics of geological cartography or *stratigraphy*. It was the first attempt to map the strata of rock formations for an entire country.

Smith kept careful notes, and produced wonderful drawings and descriptions. He was the first to identify what we now call the Jurassic strata, and much of his nomenclature survives in geology text books. He had little interest in the origins of fossils or how they related to geological history, however. Nor did he speculate on the origins of the strata so as to involve himself in the debate between the Neptunists and Volcanists.

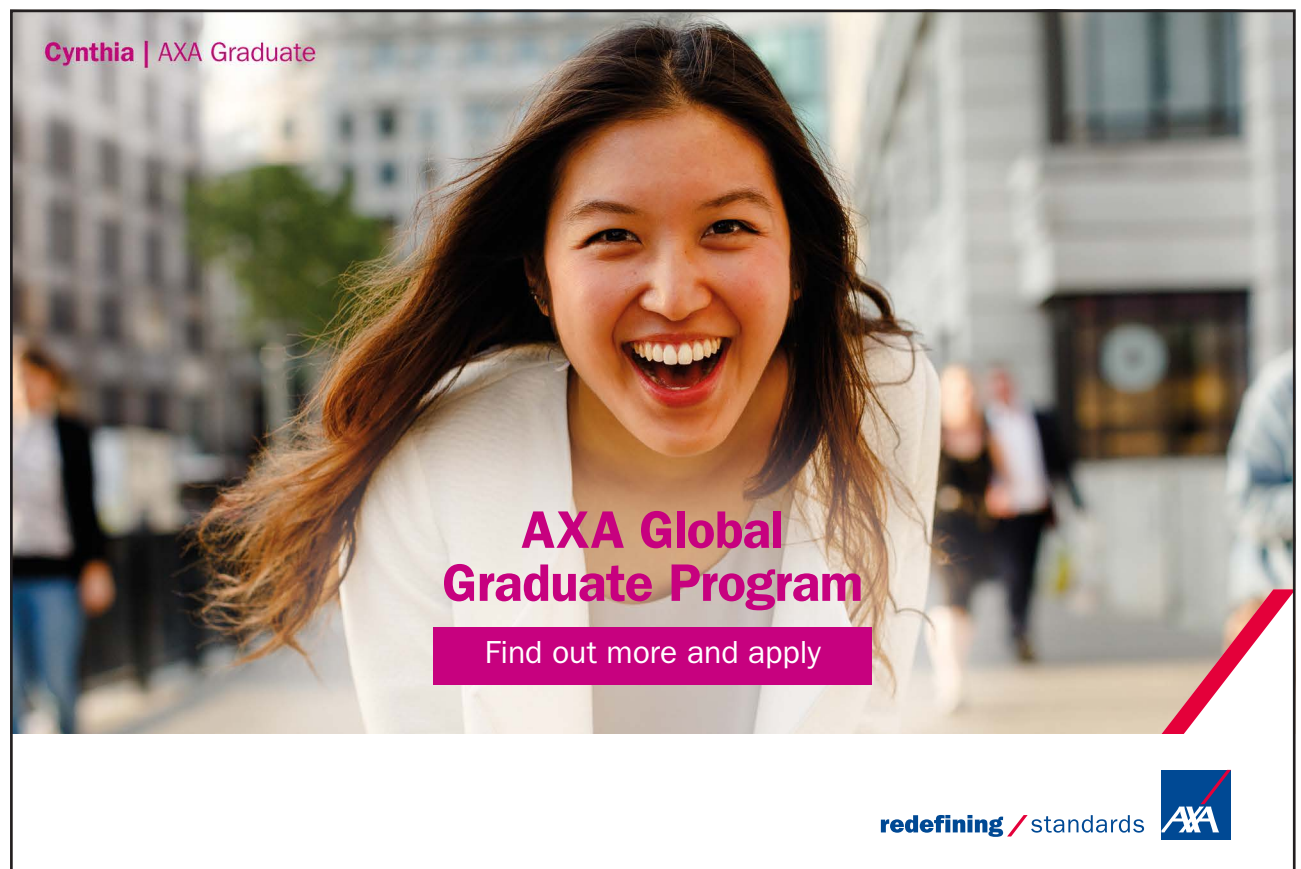

Cynthia | AXA Graduate

AXA Global Graduate Program

Find out more and apply

redefining / standards AXA

But Smith's observations raised a number of questions: fossils found in different strata suggested that they had lived, and were perhaps created, at different times. Had there been more than one creation? Other fossils appeared to be extinct. Had God changed his mind? Uniformitarianists assumed constancy in natural law, but did this mean there was not immutability of the species? Had God made mistakes? If God had made mistakes, could he do so again? These were deeply disturbing questions.

Some of the answers to these upsetting questions were provided by **Georges Cuvier** (1769–1832), who in 1794 was Professor of Vertebrate Zoology at the Paris Natural History Museum that had become part of Buffon's Jardin du Roi.

Cuvier made his greatest contributions in paleontology. It was Cuvier who first figured out how to reconstruct an entire animal from just a few bones. He used the principle of homology. Like bones and structures suggested certain patterns of structure. Fangs were connected to meat eating predators. Hoofs were associated with grass eating herbivores, etc.

Cuvier also discovered that certain fossils were associated with specific strata, and that the rocks could be identified and dated according to their fossil population, again containing many species that were extinct. Cuvier noticed that the fossil record of certain species often ended abruptly, only to be replaced in the fossil record by another animal. Sometimes clams and oysters, sometimes fish, sometimes dinosaurs, sometimes mammals or birds. It was Cuvier who first discovered the Pterodactyl. One major species was absent from the fossil record, however, *Homo sapiens*.

What did the historical record indicate, Cuvier asked? How do we account for certain species dying out and others taking their place? Cuvier postulated that this was the consequence of ancient catastrophes. Floods, tidal waves, volcanic eruptions had devastated the land, killing off resident species which made room for new species to move in. In his studies of the Paris basin, Cuvier detected the record of two ancient floods. The absence of human remains suggested that humans occupied the region after the second flood. Cuvier reasoned that the second flood must have been Noah's flood.

Again, while Cuvier did not directly challenge scripture, Cuvier's catastrophism seemed to conflict with Hutton's uniformitarianism. Did Cuvier ancient catastrophes, not gradual geological processes, account for the fossil history? But as we shall see, the two theories did not necessarily conflict.

Gone, almost completely, was the idea of the immutability of the species. Like Hutton, Cuvier depicted the geological story of Earth history on a vast canvas of time. But Cuvier did not postulate an evolutionary theory. While species thrived and died as the consequence of repeated geological catastrophes, the origins of species remained unexplained in Cuvier's system.

The last paving stone on the Geological Road from Newton to Darwin is marked with the name **Charles Lyell** (1797–1875) Lyell is the most important of these geologists because he was the most distinguished and influential geologist of his time. He was a close personal friend of Darwin and greatly influenced the writing of *On the Origin of Species*.

There is not a modern geologist who does not know of the work of Charles Lyell. [He is the Newton or Darwin of Geology]. His three volume *Principles of Geology* (1833) was the most important and influential text on geology of the 19th century. It went through 12 editions by the time of Lyell's death in 1875 and set the standard for establishing the modern discipline of Geology.

Lyell's *Principles* was a vast, comprehensive and synthetic work summarizing the best of geological data and theory. Lyell reconciled Cuvier and Hutton. As Cuvier had indicated, the evidence of the strata was clear that there had been a succession of geological events in which certain species had died to be replaced eventually by others. But Lyell rejected Cuvier's catastrophic theory in favor of Hutton uniformitarianism. Lyell argued that all rocks we now see on Earth were formed by the same slow chemical and physical processes which we see today.

Like Hutton, for Lyell the key to understanding the geological past is to know the present. And he found no evidence that catastrophe contributed to anything but local change. For example, he studied the volcanic activity of Mt. Etna in Sicily and concluded that even the volcanic building up of the mountain took place over eons. Second, by calculating the rate of sedimentation in the Mississippi delta, he was able to estimate the number of years the river delta and valley had been in the making.

His conclusion was that both volcanic building up and sedimentary wearing down required repeated cumulative effects over vast, immense periods of time. Even if Lyell were correct, there remained a major problem: In this slow uniformitarianism dance of nature, some species died out and others appeared. Lyell, like Cuvier, had no explanation for the origin of the species. (See Link 9.9.)

Link 9.9 From Lyell

http://www-tc.pbs.org/wgbh/evolution/library/02/4/images/l_024_01_1.jpg

10 Classical Biology (1800–1900)

10.1 Evolution

Along with Aristotle, Galileo, Newton, and Lavoisier, **Charles Darwin** (1809–1882) is one of the scientists who define their age. We have thus far discussed more physical scientists than biological scientists. But it is important to realize that the development of classical chemistry, electricity and magnetism, and thermodynamics happened in parallel with classical biology.

The physical sciences have lent themselves more easily to cosmological discussions, while side-stepping the difficult religious questions of the meaning of life and death. Religion ultimately deals with death – and so does biology. Central to Darwin's quest was why do living things die?

Thomas Malthus, whom we will discuss further under the origin of social science, wrote about population expansion. He is considered the inventor of economics (the so-called *dismal science*). Malthus's *An Essay on the Principle of Population* was published in 1789 and became a major influence on Darwin.

I joined MITAS because
I wanted **real responsibility**

The Graduate Programme
for Engineers and Geoscientists
www.discovermitas.com



Month 16
I was a construction supervisor in the North Sea advising and helping foremen solve problems

Real work
International opportunities
Three work placements





After reading Malthus, Darwin noted his reflections on the struggle for survival and death. A struggle for existence inevitably follows from the high rate at which all organic things tend to increase. Every being must suffer destruction during some period of its life. Otherwise, on the principal of geometrical increase, its numbers would quickly become so inordinately great that no land could support the product. Hence, as more individuals are produced than can possibly survive, there must in every case be a struggle for existence. But in this struggle for existence, in which death is an inevitable outcome, there must also be the survival of the species.

On the Origin of Species (1859) is less about *origins* than it is about the *future* of species – and that is why Darwin's theory is so religiously controversial.

Charles Darwin was born in Shrewsbury, England, on the River Severn near the Welsh border, on Feb. 12, 1809. (Abraham Lincoln was born the same day.) He was the son of a successful physician, Robert Darwin, and the grandson of Erasmus Darwin, famous botanist and author of *Zoonomia: or Laws of Organic Life (1794)*. (This is evolution without a mechanism.)

Young Darwin attended the School in Shrewsbury, but he did not profit from the classical education of the day. While at Shrewsbury, Darwin and his older brother set up their own chemistry laboratory, where they made various gases and compounds. Darwin earned the nickname *Gas*, and was publicly rebuked by the head-master for being a dilettante.

His time at the School seemed wasted, so his father sent him on to Edinburgh University with his brother to study medicine. Although his brother earned an MD degree, two years study of medicine at Edinburgh University proved unsuccessful for Darwin. He failed to qualify in medicine at Edinburgh and thus, he would not follow in his father's or his brother's footsteps to become a physician. Again, he was interested in chemistry, but bored by anatomy. Worst of all, he became sick to his stomach witnessing a surgery which was an especially bad operation on a child.

In 1827, he was off to Christ College, Cambridge to study for a B.A. to prepare him for ministry in the Church of England. At Cambridge, Darwin was again an indifferent student. Unfortunately, he had forgotten much of the Greek and Latin he had learned at school and he felt much of his time was wasted at Cambridge.

Darwin recalled that one of the best books he read at Cambridge was Paley's *Natural Theology*, which very much impressed him. Paley said that there cannot be a design without a designer; a contrivance without a contriver; order without choice; arrangement without anything capable of arranging; all of which imply the presence of intelligence and mind.

The implied presence of intelligence and mind, of course, offered proof of a designer God. Darwin not only accepted the hand of the Creator, but at this time he also believed in the immutability of the species. It was also at Cambridge that he first learned about the evolution theories of Lamarck, whom he compared to his grandfather, Erasmus Darwin.

But at Cambridge, Darwin was more interested in card playing, drinking and shooting. He also spent a good deal of time, pleurably he reported, collecting beetles.

While he did not follow a rigorous course of study at Cambridge, at the encouragement of his brother, he became acquainted with Professor Henslow, one of Cambridge's distinguished botanists. Every week, Henslow held open house where students and faculty gathered for sherry, coffee, and cigars. Darwin enjoyed these weekly meetings, and became friends with Henslow who encouraged him to study geology. This was advice that Darwin followed, establishing himself a reputation as a budding geologist.

On returning from a geological outing to northern Wales in 1831, Darwin found a letter from Professor Henslow waiting for him. Henslow informed Darwin that he had been recommended to sail with Capt. Fitz-Roy on the H.M.S. Beagle as a volunteer naturalist without pay. It was the custom in those days for the captain of such an expedition to have a *gentleman companion* because the captain could not socialize with his crew. At first Darwin's father opposed, but after the intercession of Darwin's uncle, his father relented. Darwin's income while on the voyage would be limited to his allowance from his father which he had spent rather lavishly at Cambridge. It was supposed the voyage of the Beagle might enforce some frugality.

The expedition was to survey and observe the coast of South America. Actually, Darwin was not the ship's official naturalist. Rather the ship's surgeon, Robert McKormick, was the official naturalist, in keeping with the custom of the ship's doctor performing this service. Darwin was on board to keep FitzRoy, who was 26, company at the Captain's table during the long voyage. The previous Captain of the Beagle had committed suicide. FitzRoy, who had worries about his own mental health, did not want to spend the entire five years alone on the ship without a friend. (The Beagle sailed from 1831 to 1836 circumnavigating the globe in the process.) (See Link 10.1.)

Link 10.1 Route of the H.M.S. Beagle

<http://www.darwinday.org/images/beagle/beaglemap-t.gif>

It was the time of exploratory expeditions. Lewis and Clark in 1804–1806; Zebulon Pike, the Upper Mississippi and Colorado, 1805–1807; the Oregon Trail opened in 1843; and John Wesley Powell's expedition into Rocky Mountains in 1868. 1838 saw the *Trail of Tears* and the forced relocation of the Civilized Tribes to Oklahoma.

It was common to carry a naturalist on board for such expeditions. In addition to companionship, FitzRoy saw Darwin's service as a way to implement the scientific capability of the ship. Darwin's duties were to observe, note, collect specimens and data on geology, paleontology, botany, and zoology. But he was hampered by constant sea-sickness and other health problems.

Darwin had brought with him the first volume of Lyell's *Principles of Geology*, and in the Cape Verde Islands became convinced of the soundness of Lyell's theory. He obtained Lyell's second volume when the Beagle stopped in Montevideo, which is about halfway down the East coast of South America.

On board the Beagle with Captain FitzRoy, Darwin coasted off of South America, visiting numerous landfalls including the Falklands, Patagonia, Chile, and Peru before heading westward across the Pacific and home to England. Gradually, Darwin became more interested in flora and fauna than in geology and paleontology.

His most famous stop on the Galapagos Islands near the equator off the coast of Ecuador, may have been anti-climatic in Darwin's mind. The Beagle spent five weeks in the Galapagos, of which Darwin spent about three weeks ashore. There is mixed evidence about whether he found exploring the Galapagos particularly exciting or enlightening. Indeed, subsequent naturalists and scholars have commented that although his collecting was diligent, it was also somewhat haphazard and sloppy.

ie business school

93%
OF MIM STUDENTS ARE
WORKING IN THEIR SECTOR 3 MONTHS
FOLLOWING GRADUATION

MASTER IN MANAGEMENT

- STUDY IN THE CENTER OF MADRID AND TAKE ADVANTAGE OF THE UNIQUE OPPORTUNITIES THAT THE CAPITAL OF SPAIN OFFERS
- PROPEL YOUR EDUCATION BY EARNING A DOUBLE DEGREE THAT BEST SUITS YOUR PROFESSIONAL GOALS
- STUDY A SEMESTER ABROAD AND BECOME A GLOBAL CITIZEN WITH THE BEYOND BORDERS EXPERIENCE

Length: 10 MONTHS
Av. Experience: 1 YEAR
Language: ENGLISH / SPANISH
Format: FULL-TIME
Intakes: SEPT / FEB

5 SPECIALIZATIONS
PERSONALIZE YOUR PROGRAM

#10 WORLDWIDE
MASTER IN MANAGEMENT
FINANCIAL TIMES

55 NATIONALITIES
IN CLASS

www.ie.edu/master-management | mim.admissions@ie.edu | [f](#) [t](#) [w](#) Follow us on IE MIM Experience

He seems to have been most enthralled by the giant tortoises and sea iguana he saw in the Galapagos. As noted by Jonathan Weiner in *The Beak of the Finch* (1995), Darwin also collected finches which now have his name. But his collection of the finches was not comprehensive, or even systematic. It was not until after he returned to England, and consulted with colleagues that he became interested in the significance of his findings concerning the adaptations of *Darwin's Finches*.

The Beagle returned to England in 1836, and three years after his voyage around the world, Darwin married his cousin Emma Wedgwood, the daughter of Josiah Wedgwood (of Wedgwood pottery). He was able to live comfortably on his allowance and inheritance from his father, and Emma's dowry. He first moved to London, and then in 1842 to the English countryside to raise his growing family. The only bad side to Darwin's comfortable life at this time was nagging ill health. He may have been suffering from Chagas' syndrome (a parasitic infection similar to African sleeping sickness), and other psychosomatic disorders.

Initially, Darwin devoted himself to geology, not biology, and became a protégé of Charles Lyell. Darwin's major contribution in geology was his *Structure and Disposition of Coral Reefs* (1842). The current theory (Charles Lyell) was that coral reefs came from coral animals dying and piling up to form a ridge on the bottom of the ocean. However, Darwin recognized that coral did not grow well in deep water. Darwin, using Lyell's principle of uniformitarianism, speculated that coral reefs formed from the gradual subsidence of volcanic cones or peaks. So, as the ocean floor lowered, the coral animals continued to reproduce near the surface and the ridge became higher (with respect to the ocean floor) over time. (See Link 10.2.)

Link 10.2 Darwin's Theory of Coral Reefs

http://en.wikipedia.org/wiki/The_Structure_and_Distribution_of_Coral_Reefs

An objection to Darwin's theory was that the coral should form a disk, rather than a ring. However, Darwin countered this by pointing out that coral developed much differently in sheltered waters as the inside of a disk would be. Lyell supported him and Darwin's contributions to geology earned him considerable respect, and he was elected secretary of the Geological Society, a high honor which connected him well to the British scientific community.

Darwin published 25 books and editions in all, the most notable of which were: *The Structure and Distribution of Coral Reefs*, 1842; *The Voyage of the Beagle*, in several parts 1839–1845; *On the Origin of Species by Means of Natural Selection*, 1859; and *The Descent of Man and Selection in Relation to Sex*, 1871.

There was more than a twenty-year hiatus between his return to England in 1836 and publication of *On the Origin of Species* in 1859. As his publications indicate, he was not entirely unproductive during this period. In fact, Darwin's notebooks reveal that he was intellectually quite active. In 1838, he read Thomas Malthus' *An Essay on the Principle of Population*, whose theories on population growth provided Darwin with the interpretive key for his own biological analysis. "Here, then, I had at last got a theory by which to work..."²⁹ he recorded in his journals. By 1842, he had written in pencil a 35 page outline of his ideas. By 1844, the manuscript had grown to 235 pages, a copy of which he gave to his wife to publish if he should die.

But then the work languished for almost fifteen years until **Alfred Wallace** (1823–1913) sent him an abstract of his own work, which anticipated Darwin's theories in almost every respect. Naturally, Darwin was alarmed that Wallace threatened to scoop his life's work. Wallace had served as a naturalist on scientific expeditions to the Amazon Basin and to the Malay archipelago. Wallace had also read Malthus's theories on population and arrived at same conclusion as Darwin had earlier. Wallace recorded: "I...wrote it out carefully in order to send it to Darwin by the next post..."³⁰

Deeply concerned, Darwin wrote to Lyell, "I never saw a more striking coincidence. If Wallace had my MS. sketch written out in 1842, he could not have made a better short abstract! Even his terms now stand as heads to my chapters."³¹ (See Link 10.3.) The issue became whether Wallace or Darwin was the originator of evolutionary theory.

Link 10.3 Wallace's Letter to Darwin (received June 18, 1858)

<http://www.plantsystematics.org/reveal/PBIO/darwin/dw04.html>

<http://www.plantsystematics.org/reveal/PBIO/darwin/dw05.html>

English society rallied to Darwin's side. Arrangements were made for Wallace to present his paper at the Linnaean Society in July 1858, where Darwin also presented extracts from his own work to secure prior authorship. Wallace yielded while Darwin worked feverishly on the *On the Origin of Species* which was published a year and a half later in November, 1859. All 1250 copies of the first edition sold in a single day.

Why had Darwin been so reluctant to publish? This had been a puzzle to scholars, although long periods of productive drought are not unusual in creative lives. Stephen Jay Gould, *Ever Since Darwin* (1977), believes that the reason for Darwin's reluctance to publish his theories was that Darwin was fully aware of the *materialistic* implications of his theories. Darwin feared that Victorian England would not welcome his book when it became aware of its Godlessness. Gould writes: "The notebooks prove that Darwin was interested in philosophy and aware of its implications. He knew that the primary feature distinguishing his theory from all other evolutionary doctrines was its uncompromising philosophical materialism. Other evolutionists spoke of vital forces, directed history, organic striving, and essential irreducibility of mind – a panoply of concepts that traditional Christianity could accept in compromise, for they permitted a Christian God to work by evolution instead of creation. Darwin spoke only of random variation and natural selection."³² Darwin's problem was not fundamentally different than Newton's. Both were fully aware of the fact that their science contradicted orthodox Christianity.

The first point that needs to be made very clearly is that Darwin did not originate the of evolution. The theory of evolution was not Darwin's chief contribution to natural history or biology. This point often gets confused. When one thinks of Darwin, one often thinks of evolution and assumes that he was Darwin's principal scientific achievement. It was not. What Darwin did was to give the *mechanism* of *natural selection* whereby evolution could logically occur.

Darwin's mechanism of natural selection is based upon three principles:

1. Populations grow exponentially
2. Variation occurs within species
3. Traits can be inherited

Given these three principles, over a vast number of generations there is a natural selection of those species which have the best survival characteristics. Slowly through this process the species evolves to be better suited to the environment. Eventually it has become another species.

There were several precursors to Darwin in evolutionary theory: Buffon, whose *Histoire Naturelle* presumed change and development in organic life – from slime to human beings; Erasmus Darwin whose *Zoonomia* also postulated a theory of organic evolution; and, Jean Baptiste Lamarck whose *Philosophie Zoologique* (1809) Darwin studied at Cambridge.

Jean-Baptiste Lamarck (1744–1829) was a French soldier, naturalist, and academic. Lamarck was wounded in the Pomeranian War with Russia and returned to Paris to study medicine. He was mentored by Comte Buffon and became Chair of Botany at the Museum of Natural History in Paris. In 1802, Lamarck was one of the first to use term “biology.” Lamarck’s theory of Evolution said:

1. Environment gives rise to changes in animals
2. Life is structured in an orderly manner

Lamarck believed in *soft inheritance* which means that an Alchemical Complexifying Force drives animals to become more complex, more perfect and to become adapted to our environment. According to Lamarck we pass these adaptive attributes on to our progeny.

For example, because giraffes stretched their necks to reach leaves higher in the trees, Lamarckian evolution would say that their offspring should be born with longer necks. (Thus, if you pump a lot of iron, your babies will be born with bulging muscles.) This process, like Darwin’s natural selection, could slowly change the species over time. Lamarck gave a lecture on his theory in 1800 and went on to publish three books on the topic.



“I studied English for 16 years but...
...I finally learned to speak it in just six lessons”
Jane, Chinese architect

ENGLISH OUT THERE

Click to hear me talking before and after my unique course download

Lamarck saw linkages between modern animals and the fossil record. He advocated an evolutionary theory based on acquired characteristics and traits. Lamarck was the first to propose a theory of evolution based upon the influences of the environment, the effects of the use and disuse of organs, and on the inheritance of acquired characteristics. Lamarckian evolution was still argued into the 20th century, partly because it had an element of spiritualism in the drive to perfection.

Robert Chambers, *Vestiges of the Natural History of Creation* (1844), actually anticipated Darwin by hypothesizing an evolutionary theory of natural history. Chambers work was widely read, especially in America, and undoubtedly was important for preparing Americans to read and accept Darwin. Chambers differed from Darwin in arguing for a teleological natural history; that is, Chambers attempted to present a theory of evolution which reconciled natural history with Biblical creation. He was not naive about the challenge. For Chambers, evolution meant God ordained natural development and progress. According to Chambers, God created the world with potentiality for growth and change through natural laws or laws of organic development.

Chambers' theory of evolution has a very familiar look to it: Comprehensive design – plenitude; Marvelous synergy – continuity and gradation; and, Central purpose – God's natural design and laws were immutable. It is very similar in these regards to William Paley's Natural Theology. While Chambers' anticipated Darwin, he apparently had no direct influence on Darwin or his theories.

Darwin never used the term *evolution*, either in *On the Origin of Species*, or other publications. (He did use “evolved” as the last word in *On the Origin*.) Darwin himself always used the term *Descent with Modification*. Darwin did not mean to imply *progressive* descent with modification, and he was always careful not to use the terms *higher* or *lower* in describing how organisms adapted to their environment. The slug is as well adapted to its environment as we are, and Darwin would ask who is to say which is *higher* or *lower* in its biological success?

Critics of Darwin have frequently insisted that Darwin advocated progressive evolution. An anti-evolution pamphlet (quoted by Stephen Jay Gould) says: “Did Man Get Here by Evolution or Creation: Evolution, in very simple terms, means that life progressed from one-celled organisms to its highest state, the human being, by means of a series of biological changes taking place over millions of years.... Mere change within a basic type of living thing is not to be regarded as evolution.”³³

Critiques of Darwin commonly miss the mark in four ways: It was Buffon, not Darwin, who implied the progressive evolution *from slime to humans*. It was Chambers, not Darwin, who offered a teleological theory of evolution; It was Lamarck, not Darwin, who argued that organisms willed their own evolutionary destiny; and, Darwin's *Dissent with Modification* was not progressive (teleological) from lower to higher forms of life as implied by the creationists.

Darwin's theory of *Descent with Modification* was developed without knowledge of genetics or the laws of inheritance. Gregor Mendel – we will discuss him later – published the results of his genetic studies in 1866, but Mendel's work remained virtually unnoticed until 1900. The first half century of debate regarding natural selection and evolution took place without any understanding of genetics.

Who were the major influences on Darwin? First there was Malthus and his struggle for existence as described in *An Essay on the Principle of Population*. (Malthus was a very dour and pessimistic social scientist. It is Malthus who first presented an interpretation of economics as the *dismal science*.) Next there was Lyell and geological uniformitarianism. If the geological world is in constant, almost imperceptible, continuous change, shouldn't the biological world be changing as an adaptation to the environment?

10.2 Darwinism

Well into the 19th century, the fossil record had not yielded any known human remains. The absence of humans from the fossil record lent credence to the belief of a special creation of humanity. Stone tools had been found in France, but there was a great deal of debate and skepticism about their origins and authenticity.

First in 1848 a skull was found in Gibraltar. Then in 1856, workers in the Neander Valley, quarrying limestone blocks on a steep hillside near Düsseldorf broke into a cave above the Neander River, a tributary of the Rhine. They discovered some old bones, including a complete skull. These findings were delivered to the scientific community for analysis: the analysis included: the low arch of the brow; the projecting lower jaw; the extreme bulging of the forehead; and the heavy posture reconstructed from the skeleton. (See Link 10.4.)

Link 10.4 Neanderthal

<http://bit.ly/19HRq0v>

This Neanderthal man provoked both alarm and great excitement. One scientist noted that the Neanderthal man was probably the remains of a Mongolian Cossack who had taken refuge in the cave while on the way to Prussia in pursuit of Napoleon's Army in 1814. It was more than fifty years before paleontologists could agree that the Neanderthal man was a Hominoid who lived between 20,000 and 100,000 BCE.

A few years later in 1868, another team of workers clearing a railroad right-of-way in France, opened another cave containing five skeletons of the so-called Cro-Magnon. (See Link 10.5.)

Link 10.5 Cro-Magnon

<http://bit.ly/1dqOcO0>

These were fortuitous discoveries being made just when Europeans were beginning to debate the origins of humanity, the historicity of the Bible (and especially Jesus), and Darwin's *On the Origin of Species*.

Cro-Magnon and Neanderthal were contemporaries (c. 20,000) – Cro-Magnon was a precursor to modern *Homo sapiens*, and Neanderthal was dying out. Neanderthal had reached a dead end.

The discovery of the bones of extinct hominoid species raised fundamental questions about the unity of the human species – and thus the timeliness of Darwin's *On the Origin of Species* (1859) and his *Descent of Man* (1871).

Thus, Darwinism came of age at a time when there were dramatic discoveries in human paleontology, and theories of social evolution (progress) and materialism was gaining momentum in Western culture.

Before discussing how Darwinism was received in American scientific circles, let's look at the Lincoln-Douglas debates of 1858 as a reminder of where Americans stood on the issue of our common humanity and race at virtually the same time that Darwin published *On the Origin of Species*.

In the past 5 years we have drilled around

95,000 km

—that's more than **twice** around the world.

Who are we?
We are the world's leading provider of reservoir characterization, drilling, production, and processing technologies to the oil and gas industry.

Who are we looking for?
We offer countless opportunities in the following domains:

- Operations
- Research, Engineering, and Manufacturing
- Geoscience and Petrotechnical
- Commercial and Business

We're looking for high-energy, self-motivated graduates with vision and integrity to join our team.

What will you be?

careers.slb.com

Schlumberger

Abraham Lincoln (Republican) was running for Stephen Douglas's (Democrat) seat in the US Senate. Their debates focused on the nature of Union and the place of Slavery in the United States. The debates are famous for Lincoln's House Divided Speech: i.e., the United States could not survive half free and half slave. Lincoln forecast the irrepressible conflict of the Civil War.

Most interesting to our study were the Lincoln-Douglas discussions about race and humanity. In the fourth debate, Lincoln, the Great Emancipator, shared common American views of race: "I am not nor ever have been in favor of making voters or jurors of negroes, not of qualifying them to hold office, not to intermarry with white people.... There is a physical difference between the white and black races which I believe will forbid the two races living together on terms of social and political equality."³⁴ Douglas went even farther than Lincoln, declaring that the American government "was made by white man, for the benefit of the white man, to be administered by white men" and that any "mixture or amalgamation with inferior races" would lead to "degeneration, demoralization, and degradation." Lincoln objected to this racial doctrine. Lincoln affirmed our common humanity and protested that in Douglas' views that "the negro is no longer a man but a brute...that he ranks with the crocodile and the reptile." From his premise that the black man shares a common humanity with all races, Lincoln finally deduced that blacks were entitled to the freedoms guaranteed in Jefferson's Declaration of Independence. Ultimately, the issue before us is not one of politics, but one of biology – the nature of race and species – a very hot topic in the mid-nineteenth century.

The first public debate concerning Darwinism took place at the Oxford University Museum on June 30, 1860, just a year after publication of *On the Origin of Species*. The debate featured the famous conflict between Thomas H. Huxley and Samuel Wilberforce, the Bishop of Oxford. The debate was scheduled as part of a general symposium on Darwin's views.

The debate was held before a packed hall filled with raucous undergraduates. Preliminary speakers, both critics and supporters of Darwin, were shouted down by the undergraduates, who wanted to get on with the main show, the debate between Wilberforce and Huxley, already known for his skepticism and atheism.

Reportedly, Wilberforce's address was given in the best of Oxford tradition: witty, droll, obsequiously polite, but biting and sarcastic – just what the Oxford undergraduates loved. One report said: "although he ridiculed Darwin and Huxley, it was done in such dulcet tones, so persuasive in manner, and in such well turned periods that the chairman could not object, only Darwin's partisans complaining of the 'ugliness and emptiness and unfairness of it.'"³⁵

What everyone remembered of this encounter was the climax. Wilberforce gallantly asked the audience, to the great delight of the Oxford students, whether women, their mothers, sisters, wives, and sweethearts, also derived from beasts, as Darwin supposed. “No, no, no!” shouted the undergraduates. Then, turning to Huxley, Wilberforce asked whether it was through his grandfather or grandmother that he claimed descent from the monkey. The undergraduates howled with delight.

Huxley was also delighted, this was the kind of rhetorical alley fighting that he loved, and turned to his friend, and declared: “The Lord hath delivered him into mine hands.” Huxley rose to defend Darwin—and presented a sober defense of the *Origin* as a legitimate scientific theory. He explained patiently that it was not Darwin’s intention to establish a direct relationship between apes and man, but only to suggest that they had perhaps descended from a common ancestor after many thousands of generations. Then he delivered his famous blow against Wilberforce: “I assert – and I repeat – that a man has no reason to be ashamed of having an ape for his grandfather. If there were an ancestor whom I should feel shame in recalling, it would rather be a man, a man of restless and versatile intellect, who, not content with an equivocal success in his own sphere of activity, plunges into scientific questions with which he had no real acquaintance, only to obscure them by an aimless rhetoric, and distract the attention of his hearers from the real point at issue by eloquent digressions and skilled appeals to religious prejudice.”

The undergraduates loved it, and the speech forever made Huxley’s reputation. Tragically, FitzRoy, Darwin’s old sea captain, now somewhat deranged, stalked the back of hall holding aloft a Bible and shouting: “The Book, The Book.”³⁶ (Fitzroy had been governor of New Zealand but later fell from grace and in 1865 slit his throat.)

Unfortunately, the Huxley-Wilberforce debate also set the tone for the discussion of Darwinism and religion. In many respects, scientists were eclipsed in the raucous debates over Darwin that were to follow. Mostly, the public debate was not about science theory, but the symbolic clash between science and religion. In fact, science became so irrelevant that in the Scopes Trial of 1925, the famous *monkey trial* challenging the Tennessee law that banned the teaching of evolution in public schools, the judge ruled the testimony of distinguished scientists was not relevant. And the judge probably ruled correctly: the scientists’ testimony was not germane to the social, religious, and political issues before the Tennessee court.

10.3 Darwinism in America

Louis Agassiz (1806–1873), represented 19th Century Scientific Creationism. Swiss born Agassiz was a Harvard Professor of geology and zoology. He was one of the most prominent biologists of the 19th century. Agassiz was well known in Europe as well as America. He was so prominent that Darwin sent him a draft of the *On the Origin of Species* before publication.

The son of Swiss Protestant minister, Agassiz was trained in the best European universities, and went to France to study with George Cuvier. (Cuvier was the great paleontologist who believed in catastrophism regarding geological development.)

Agassiz was a successful scientist – as a student he studied fossil fishes; he drank heavily at Cuvier’s well. In general, Agassiz rejected the doctrine of evolution, but like Cuvier was drawn towards William Paley’s natural philosophy. Cuvier had been opposed to Lamarck – the opposition to Lamarckian evolution carried over into Agassiz’ criticism of Darwin.

In all creation, Agassiz saw the wonderful and purposeful hand of God. Agassiz’ view was neither an unpopular or unusual position in the 19th century. But he was also a rigorous scientist. At Harvard, he insisted that his students study nature from nature and introduced dissection of animals into the Harvard curriculum. In this sense he was also a disciple of Vesalius and Harvey.

Agassiz also admired Charles Lyell’s *Principles of Geology*, but rejected Lyell’s uniformitarianism. It was Agassiz who studied the problem of erratic boulders found across England, France and Europe, and determined that they had been deposited by historic glaciation. He was the originator of the first theories of ice sheets covering the northern hemisphere. Theories of periodic ice ages fit well into his catastrophic view of geological change.

Agassiz was one of the most influential members of the scientific establishment – and counted among his circle the intellectual and literary leaders of Boston and Cambridge, including Emerson and Longfellow. He was well respected and successfully raised money for building one of the finest natural history museums in the country.

Given the influence of Cuvier and catastrophism, Agassiz’s reaction to Darwin’s manuscript was predictable. Agassiz believed in the successive creation of organisms separated by catastrophes. Agassiz believed that the fossil record can best be explained by God’s successive creative acts.

Although Agassiz’s views were not Biblical, neither were they incompatible with the Biblical story. According to Agassiz, The Creator, much like Newton’s creator, set forth the basic plan and pattern, but did not manage the details. Thus Agassiz could admit to a certain amount of change and development.

In the margin of *On the Origin of Species*, Agassiz wrote: “What is the great difference between supposing God makes variable species, or that he makes laws by which species vary?”³⁷

It is important to note that Agassiz is interested in developing a scientific system, not a theological one. From his study of nature, Agassiz believed that there existed distinct, identifiable *Zoological Provinces* in nature with their distinctive flora and fauna. Australia was a perfect example of a zoological province – how distinctive it is – but all nature was *Australia like*.

In Agassiz’s reasoning, the great richness and variety of the species found in the world’s distinctive zoological provinces implied *Special Creations*, which in turn implied a *Unique Creation*.

Agassiz believed in separate creations for White, Blacks, and Browns. In his public lectures, Agassiz applied his idea of *zoological provinces* to humans, and stated that Blacks had an origin distinct from Whites. Agassiz did not believe that Blacks could trace their ancestry to the sons of Noah, that is, Noah of the Biblical Great Flood catastrophe.

Lecturing in Charleston, SC, Agassiz affirmed not only that Blacks and Whites were of distinct origin, but also that Blacks were probably a physiologically and anatomically distinct species. Agassiz statements reinforced southern arguments in defense of slavery, and established Agassiz as one the most popular scientists in the South. It was significant that he came from the heart of the abolitionist north.

Excellent Economics and Business programmes at:



university of
 groningen



“The perfect start
 of a successful,
 international career.”

CLICK HERE
 to discover why both socially
 and academically the University
 of Groningen is one of the best
 places for a student to be

www.rug.nl/feb/education

Ironically, despite his popularity in the South, a few biblical fundamentalists objected to his re-interpretation of the Biblical account of creation. The idea that Blacks enjoyed a separate creation struck at the heart of a literal reading of the stories about Adam and Eve and Noah's Ark. Agassiz responded that the Genesis story only referred to the creation of one of the zoological provinces, including the plants and animals associated with Adam and Eve. There were at least a dozen separate, successive creations in different parts of the world, Agassiz maintained.

Agassiz saw the debate between plurality of creation or unity of creation. He maintained that all humans enjoyed a spiritual and moral unity, but viewed zoologically, "the several races of men were well marked and distinct."³⁸ He defined eight races of humans to correspond to the eight major zoological provinces: "the Caucasian; Arctic; Mongol; American Indian; Negro; Hottentot; Malayan; and, Australian."³⁹ (How ironic it is that we used a modified version of Agassiz' *eight races* for the purposes of affirmative action today).

Agassiz on the Bible – "The Bible was not a textbook of natural history and could not be treated as such by a mind seeking only to discover the truth. Science had a right to investigate these questions without reference to politics or to religion."⁴⁰ Then he concluded, it was not really very important whether human groups were called races, varieties, or species – what was important was the recognition of the fundamental differences between the races. In addition to obvious physical differences, for example, Agassiz believed that Blacks were *by nature* submissive, obsequious, and imitative – and the argument of the *unity* of the human race would mock science if it implied that Blacks were equal to Whites.

Darwin, himself, was very much in touch with this debate between *Pluralism* and *Unity* of human species. Remember that Darwin had extensive contact with blacks and other races, much more so than Agassiz. In contrast to Agassiz, Darwin, was an ardent and outspoken anti-slavery advocate and believed in the unity of the races.

Asa Gray (1810–1888) was a colleague of Agassiz at Harvard. Gray was a distinguished botanist – not as prominent as Agassiz – but was well known and also received a copy of the *On the Origin of Species* from Darwin. Gray became the principal pro-Darwin scientist in the US.

Gray, like Darwin, was an ardent anti-slavery advocate. Gray argued for the unity of the Human Species, and against pluralism which he believed gave aid and comfort to pro-slavery forces. But Gray also believed that Agassiz's argument for separate creations was scientifically flawed. The Agassiz-Gray debate was about science, but it had far reaching social implications.

Gray, interestingly, remained a Christian Darwinist, arguing that: “Natural Selection not Inconsistent with Natural Theology.”⁴¹ Gray as a rationalist, distrusting orthodox religion; but he was also pious, evangelical and became a Unitarian. While Agassiz explained the variation of the species by proposing separate creation in eight zoological provinces, for Gray the key to explaining the variety of the species was to give up the idea of the fixity of species.

The debate between Gray and Agassiz focused on the *Transmutability* of the species. Gray, the botanist, read *On the Origin of Species* and concluded that one species probably passed into another and that natural selection was the likely mechanism. But while he was willing to accept the ideas of evolution (and perhaps natural selection), Gray argued that he should not change his religious and philosophical beliefs beyond that required by scientific evidence.

As a taxonomist, Gray perceived order and design in nature as portrayed by the structure and function of organisms. However one explained them, Gray believed that there was design in the adaptation of organisms to their environment. In short, Gray could not quite give up the *Argument from Design*, then and still, a powerful argument for God and purposefulness in the universe.

11 Origin of the Social Sciences (1750–1900)

11.1 Economics

Thomas Malthus (1766–1834) lived and wrote before Karl Marx. Malthus was an Englishman who graduated from Cambridge in 1784 where he majored in mathematics. Malthus was not so much a critic of capitalism as he was a prophet of doom regarding the workings of Adam Smith's *invisible hand*.

You could think of Malthus as the Jeremiah (the broken-hearted prophet) of early capitalism. At a time when there was vast optimism about the future of the Industrial Revolution, Malthus warned that industrial England was heading towards economic disaster. What a contrast to Adam Smith!

Proponents of the industrial revolution believed that it would ease the grinding poverty of Europe's peasant class, and would provide prosperity and higher standards of living for owners and workers alike. Malthus took none of this for granted, but tried to work out mathematical relationships between technology, resources, and population. Was there a law of demography on population growth?



**American online
LIGS University**
is currently enrolling in the
Interactive Online **BBA, MBA, MSc,
DBA and PhD** programs:

- ▶ enroll **by September 30th, 2014** and
- ▶ **save up to 16%** on the tuition!
- ▶ pay in 10 installments / 2 years
- ▶ Interactive Online education
- ▶ visit www.ligsuniversity.com to find out more!

Note: LIGS University is not accredited by any nationally recognized accrediting agency listed by the US Secretary of Education. More info [here](#).



Malthus became a student of population history, collecting and analyzing data from ancient Greece and Rome, China, and Europe, including population data concerning the rise and fall of population during the Black Death [plague] in the 14th century and after. In 1798, Malthus first published *An Essay on the Principle of Population*. His essay went on to six editions between that time and 1826.

His major conclusion was that population growth increased geometrically, while food supply tended to increase by arithmetic progression. An arithmetic progression is linear, e.g. 2,4,6,8,10... A geometric progression is exponential, e.g. 2,4,8,16,32... In the first case we added 2 to each step; in the second case we multiplied by 2 for each step. (A fun puzzle when I was a child was to take a penny and multiply it each day by 2 for a month. At the end of the month (30 days) the amount was more than five million dollars!) (Figure 11.1.)

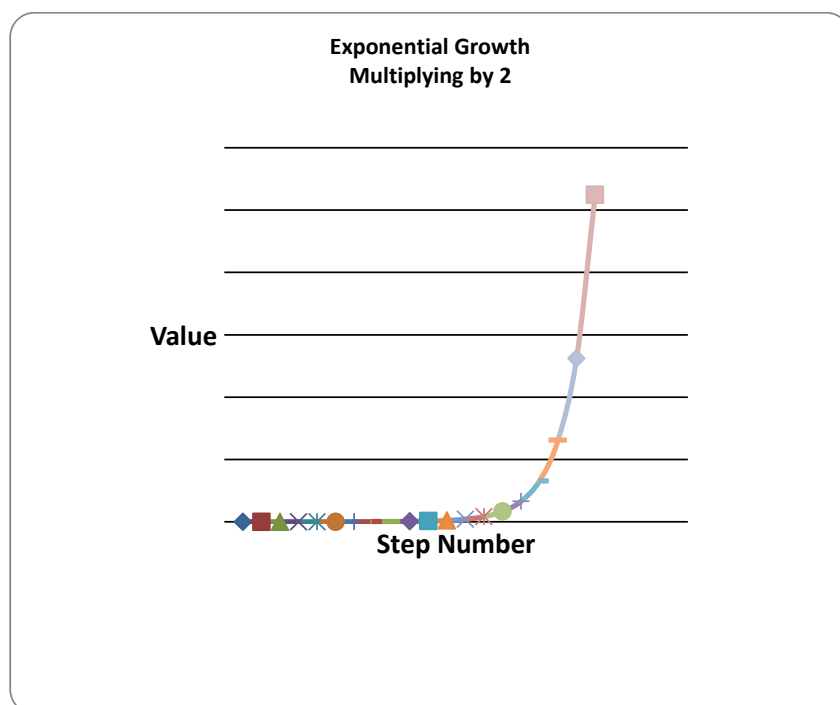

Figure 11.1 Exponential Growth

The problem becomes obvious and ominous. According to Malthus, population will always outrun food supply. In an industrial state, the specter of famine will always haunt the economy. Obviously, Malthus' prediction has not come true, at least globally. But Malthusian's warn us not to become complacent.

Malthus missed two mitigating factors: The opening of vast new agricultural lands in Americas, Russia, and Australia; and, the development of transportation systems to market grains. The invention of refrigeration and chemical fertilizers and preservatives have also been an important factors that improved nutrition.

However, Malthusians contend that the population problems now being experienced by third world countries confirm Malthus and should be a warning to the developed nations. We may yet reach the crisis point Malthus predicted.

11.2 Sociology

In general, the 19th Century embraced the doctrine of scientific and technological progress and affirmed as well the idea of social progress. While the people of the 19th century were not naive about human sin and persistent poverty and suffering, western culture believed that through reason and science humanity could gradually, steadily, and progressively improve the conditions of life. Some individuals actually believed in the perfectibility of the human race.

Faith in science, or the scientific method, was so great that there was virtually no discipline, no phenomenon, no realm of life that *scientism* did not invade. By the end of the 19th century, history, anthropology, psychology, medicine, sport and recreation, industrial production, child rearing and education, criminology and penology – everything was studied scientifically. New academic disciplines in the social sciences, agriculture, architecture, and even the law, achieved legitimacy by becoming objectively *scientific* in their choice of problems and conduct of research.

For the first time, even the Bible was subjected to scientific, objective study or analysis. The Bible's sacred books were now treated as historical literature and documents – through literary analysis, the Holy Scriptures former unity was dissolved into fragments of historical eras, kingdoms, and multiple authors – a single Biblical story, such as Noah's Flood, might actually be constructed from three or four versions reflecting the different historical or cultural experiences of the people who wrote them. Indeed, the new scientific historical criticism even raised questions about the historical Jesus. A great deal of 19th century biblical scholarship was spent in search of the *historical Jesus*.

The best known of the scholars who pursued the scientific study of society was **Auguste Comte** (1798–1857) known as the founder of sociology. He called his philosophy *positivism*, claiming he had discovered the *laws of human progress*. Comte believed that the story of history moved through three stages: the theological stage – the most primitive – natural and historical events are controlled by the Gods; the metaphysical stage – not unlike the ancient Greeks and scholastics – events explained by Spirit, Ideal Form, etc.; and, the Positive stage – in which the mathematical laws of material causes are discovered.

Comte also believed there was a hierarchy in the sciences: mathematics, astronomy, physics, chemistry, biology, and sociology, all ultimately materialistic and mathematical.

The discipline of *Statistics* was first developed in the social sciences and later applied to the natural sciences. In the final stage of history, the positivist era, all knowledge would be unified into a single comprehensive discipline of sociology. From Comte's perspective, understanding the laws of historical succession freed humanity from determinism – the major object of materialism. To know the laws of society and history enables one to be able to participate actively and dynamically in being a mid-wife for the new social order.

Comte's philosophy was popular because it was in tune with European's belief about their historical destiny.

11.3 Political Science

Karl Marx (1818–1883) was the father of *Dialectical Materialism*. If one were to list the most influential thinkers of the 19th Century that have had the most impact on the 20th century, I think one would have to include: Thomas Jefferson, Charles Darwin, Sigmund Freud, and Karl Marx.

Marx was steeped in the philosophical, social, and economic thought of 18th century *philosophes*, particularly Hegel and to some extent, Darwin. Apparently, Marx wanted to dedicate *Das Kapital* to Darwin, and even when Darwin refused the honor, Marx sent him an inscribed, autographed copy.

DON'T EAT YELLOW SNOW

What will your advice be?

Some advice just states the obvious. But to give the kind of advice that's going to make a real difference to your clients you've got to listen critically, dig beneath the surface, challenge assumptions and be credible and confident enough to make suggestions right from day one. At Grant Thornton you've got to be ready to kick start a career right at the heart of business.

Sound like you? Here's our advice: visit [GrantThornton.ca/careers/students](https://www.grantthornton.ca/careers/students)

Scan here to learn more about a career with Grant Thornton.

 **Grant Thornton**
An instinct for growth™

© Grant Thornton LLP. A Canadian Member of Grant Thornton International Ltd

Marx wanted to be to economics and history what Darwin had been to biology. Marx, in a letter to his collaborator, Friedrich Engels, praised Darwin's theory of natural selection as the "natural history foundation for our own viewpoint" [historical materialism]. He wrote to Ferdinand Lassalle, German socialist: "Darwin's work is most important and suits my purpose in that it provides a basis in the natural science for the historical class struggle. One does, of course, have to put up with the clumsy English style of argument. Despite all shortcomings, it is here that, for the first time, 'teleology' in natural science is not only dealt a mortal blow but its rational meaning is empirically explained."⁴²

Marx was born in the Rhineland, Germany, of Jewish parents. Young Marx dreamed of a university position in philosophy. But he was unsuccessful and turned to journalism instead. While in Berlin he was much influenced by Hegel, and became one of the young Hegelians.

George W. Hegel (1770–1831) was Professor at the University of Berlin, and one of Immanuel Kant's most important followers. Hegel opposed the empiricism and materialism that characterized French and English 18th and 19th thought. Hegel believed that the natural, material world depended on the mind or consciousness for its existence. The world we have not experienced, in effect, does not exist for us. Thus it is moot for Hegel to consider nature or the material world beyond consciousness of the Mind of God, or Spirit. It simply can have no meaning. *What is rational*, Hegel concluded, *is real, and what is real is rational*. Our ideas then, forge reality.

How then does God think? God's consciousness is expressed collectively through the thinking of humanity. Our thoughts are God's thoughts. According to Hegel: "Man and God are a Unity. History is the continuing unfolding of Absolute Spirit's (God's) creative self-realization. God becomes conscious of Himself as God through human history. God becomes God through us."⁴³ The ultimate embodiment of Spirit or Geist is in the state. Only the state can blend liberty and authority – thesis and antithesis – to achieve true freedom and autonomy.

Shocked by the injustices of the industrial revolution, and the great disparities of wealth between rich and poor as evidenced in the capitalistic system, Marx denounced the exploitation of the workers and proletariat by the capitalists in his famous, and readable, *Communist Manifesto* (1848). His theory of history, on the other hand, is most completely worked out in his magnum opus, *Das Kapital* (1867), which is verbose and turgid. Marx offered what he described as a *scientific* interpretation of history, based on his extensive reading in the British Museum.

Marx theorized that history has progressed through stages: hunting gathering; agricultural; feudal and manorial; bourgeoisie merchants; and modern industrial capitalists. The next saga of history would see the revolt of the workers, the establishment of socialism, and eventually, the creation of a classless society, and a withering away of the state, and the end of history.

Like Hegel, Marx's version of history was both teleological and dialectical. What Marx rejected was Hegel's Idealism (i.e. God), rather he attempted to adopt Darwin's categories of materialism. What did Marx understand by materialism? Marx rejected all forms of supernaturalism whether theological or philosophical. This is what he understood to be naturalism. He believed that all human experience is based on sense experience. He rejected all claims of idealists that knowledge comes from God. All knowledge comes through scientific investigation. He believed that religious ideas and practices are products of human imagination, not God's action or inspiration. Religion was invented by humans for social and psychological needs. And, he believed that scientific and philosophical knowledge is measured by its usefulness. In sum, Marx's materialism was a composite of naturalism, empiricism, positivism, atheism, and pragmatism.

While Americans were disturbed by Darwin's materialism; for the most part, they rejected outright Marx's materialism as applied to history.

11.4 Psychology

Sigmund Freud (1856–1939) was born in Freiberg, Bavaria which is now part of the Czech Republic. In 1859 his family moved to Leopoldstate (Vienna). Freud attended high school in Leopoldstate in 1865. He first planned to study law but then registered with Faculty of Medicine at the University of Vienna receiving his medical degree in 1881. Freud did research from 1884 to 1887 in cocaine therapy for hysteria. He opened a neurologist office in 1886.

.....Alcatel-Lucent 

www.alcatel-lucent.com/careers

What if you could build your future and create the future?

One generation's transformation is the next's status quo. In the near future, people may soon think it's strange that devices ever had to be "plugged in." To obtain that status, there needs to be "The Shift".

Freud worked and published over the next decade and in 1920 was appointed Professor on the Faculty of Vienna. In 1938 he exiled himself to London to escape Nazi anti-Semitism.

When Freud entered psychiatry, there were only two therapies for mental illness: surgery and drugs. We owe Freud for the concept of the unconscious mind and the use of the interpretation of dreams to understand better the unconscious. Freud's theories depended heavily upon the sex drive in human beings. Freud gave us *psychotherapy*, the concept that *the mind can understand and heal itself*.

Freud classified the development of the mind in three stages: the Id is present at birth, entirely instinctive and seeking gratification; the Ego develops after birth, deals with reality (including the subconscious and preconscious) and tries to satisfy the Id in socially acceptable ways; and the Superego, which begins to develop around 5 years and internalizes morals and ideals, right and wrong.

Freud tried to be the Linnaeus of mental illness. He thought he could classify each illness then determine the therapy required. His one-time student, Carl Jung dispelled this idea and took psychiatry in another direction to focus on the individual.

On religion, Freud said: "Religion is comparable to a childhood neurosis." "In the long run, nothing can withstand reason and experience, and the contradiction religion offers to both is palpable."⁴⁴

In 1880, Fyodor Dostoevsky published his final novel, *The Brothers Karamazov*. In his autobiography, Freud said that he learned psychology from Dostoevsky. Carl G. Jung, as we mentioned above, was an early collaborator with Freud. After years of clinical research, Jung concluded that each person is an individual and their mental illness must be dealt with individually. A good understanding of Freud can be found in *The Interpretation of Dreams*, which he published in 1900. Excellent books by Jung are *The Undiscovered Self* (1975) and *Dreams, Memories and Reflections* (1962).

11.5 Social Science and Statistics

Francis Galton (1822–1911) was a cousin of Charles Darwin. They had in common Erasmus Darwin for a grandfather. Galton was precocious, reading at 2 and learning foreign languages by 5, and moving on to Shakespeare and poetry by 6. Like Darwin, he was urged to study medicine but did not like it. He then studied mathematics at Cambridge from 1840 to 1844 getting a B.A. degree in 1844 and then an automatic M.A. degree in 1847 without additional work.

Galton's father died in 1847 leaving him independently wealthy. He took advantage of his wealth and traveled extensively, going to parts of Africa that were little explored, as well as other areas. He won the Royal Geographical Society Gold Medal in 1853.

Galton was in communication with Darwin and was in the audience in 1860 at the famous Huxley/Wilberforce debate. When Galton read *On the Origin of Species* (1859), he realized that mathematics might be applied to human variations. Gauss had developed the mathematics of the normal distribution (see Appendix 6) including the statistical analysis of the mean and standard deviation. (Galton actually introduced the term *standard deviation*.)

Galton collected vast amounts of data trying to determine all sort of human properties from physical features to more esoteric attributes such as *beauty* and *eminence*. He found that many human attributes were normally distributed. He thought it would be possible to determine if human attributes were hereditary. Galton coined the term *eugenics* and felt it might be possible to improve the human race by encouraging higher quality people to marry and have children. (Because of this philosophy, many have historically blamed Galton for the negative aspects of the eugenics movement, the most extreme of which was carried out by the Nazi party in Germany in the 1930s and 1940s.)

Galton's data, however, surprised him on the inheritance issue. For example, he found that tall parents had above average height children but in a few generations the population was back to the mean value of height for the society. He also classified people for *eminence* over several generations and, while some children seemed to inherit eminence, the grandchildren did so to a lesser extent. Galton developed the idea of *reversion to the mean*. (We now say *regression to the mean*.) Here is Galton's statement:

“The child inherits partly from his parents, partly from his ancestry.... [T]he further his genealogy goes back, the more numerous varied will his ancestry become, until they cease to differ from any equally numerous sample taken at haphazard from the race at large.... This law tells heavily against the full hereditary transmission of any given.... The law is even-handed; it levies the same succession-tax on the transmission of badness as well as goodness. If it discourages the extravagant expectations of gifted parents that their children will inherit all their powers, it no less discountenances extravagant fears that they will inherit all their weaknesses and diseases.”⁴⁵

Galton's most famous publication was his 1869 book *Hereditary Genius: Its Laws and Consequences*. Galton made contributions to many fields of science including statistics, psychology, biology, and meteorology. He was important in criminology for his study of finger-prints, a human attribute that does not change over a life-time. Galton effectively invented population genetics but, like Darwin, he didn't know about Mendel when he was doing his work. Darwin, Mendel, and Galton were doing their research at the same time. What incredible collaborations could have occurred among them had Mendel been known to the other two.

11.6 Social Darwinism

The scientific debates between professional scientists – Agassiz and Gray – were obviously colored by the moral and social implications of Darwinism. By the end of the 19th century most biologists accepted the idea of evolution – but as we have seen with Gray, not necessarily the mechanism of natural selection with its materialist implications.

If the scientific debate focused on the issue of the plurality or unity of creation – the religious debate centered instead on the *Concept of Design*. That is, whether any *supernatural* intelligence or power (God) ruled over or within creation and history, giving it purpose and meaning. As we have already stressed, the heart of the Darwinian interpretation is the doctrine of natural selection. The religious response, could be three fold: Deny evolution and/or natural selection on scientific or dogmatic grounds; Harmonize religion and biology by arguing that evolution and/or natural selection described in better detail (and science) than Scripture the operation of God in the natural (biological) world; or, Decide biology and religion had nothing to do with one another: that religious truth was *spiritual* and scientific truth was *material*.

What we find historically, is that much of the old guard, i.e. Darwin's generation, among the clergy, took the first option. But that group was greatly handicapped in refuting Darwin because they did not understand the science. They became isolated from the mainstream of the intellectual tradition and their successors still are.



Join the best at
the Maastricht University
School of Business and
Economics!

Top master's programmes

- 33rd place Financial Times worldwide ranking: MSc International Business
- 1st place: MSc International Business
- 1st place: MSc Financial Economics
- 2nd place: MSc Management of Learning
- 2nd place: MSc Economics
- 2nd place: MSc Econometrics and Operations Research
- 2nd place: MSc Global Supply Chain Management and Change

Sources: Keuzegids Master ranking 2013; Elsevier 'Beste Studies' ranking 2012; Financial Times Global Masters in Management ranking 2012

Maastricht
University is
the best specialist
university in the
Netherlands
(Elsevier)

Visit us and find out why we are the best!
Master's Open Day: 22 February 2014

www.mastersopenday.nl



Click on the ad to read more

Younger clergy, especially the educated clergy who learned their biology towards the end of the 19th century, tended to take the third option, that is, they simply walked away from the problem. A middle group (transition group) tried for a time to work a compromise, but without success.

For example, consider Pastor James Woodrow, a Presbyterian, and Fr. John Augustine Zahm, a Roman Catholic. James Woodrow (1828–1907) was the Uncle of Woodrow Wilson. He was Professor of *natural science in connection with divinity* at the Presbyterian Seminary of Columbia, South Carolina. In 1884 Woodrow was asked by his governing board to declare himself on the question of evolution. He chose as his audience the Seminary's Alumni Association – many of them, his students.

Woodrow was himself a student of Agassiz at Harvard, but had been swayed by Gray, and had come to accept the soundness of *On the Origin of Species*. In his talk, he tried to give his former students a way out of the Darwinian materialist trap. He argued that there were two kinds of truth – scientific and scriptural (an argument as old as Galileo). And you could accept the findings of science while keeping your faith.

Woodrow reviewed another challenge to faith – the Copernican Revolution. As Woodrow noted, those who wanted harmony between science and scripture had found wonderful confirmation in Ptolemaic astronomy and the Bible. But Galileo had clearly taught, Woodrow reviewed, that the Bible was not written to teach astronomy, and could not be relied upon for that purpose.

Now Woodrow cleverly quoted John Calvin. “Moses does not speak with philosophical acuteness of occult mysteries.... He who would learn astronomy, and other recondite arts, let him go elsewhere.”⁴⁶ Woodrow went on to say: “I have found nothing in my study of the Holy Bible and of natural science that shakes my firm belief in the divine inspiration of every word of that Bible, and in the consequent absolute truth, the absolute inerrancy, of every expression which it contains, from beginning to end.”⁴⁷

Regarding the subject at hand, Evolution, Woodrow thought it was self evident that continuous change – in all nature – was life's one constant. But Woodrow could not accept Agassiz's non-Biblical theory of separate creations. “Evolution does not include reference to the power by which the origination is effected: it refers to the mode, and the mode alone.” God, then, is the power behind evolution – and this is a religious statement, not a scientific statement, Woodrow is careful to qualify.

“I would say in conclusion, that while the doctrine of Evolution in itself...is not and cannot be either Christian or anti-Christian, religious or irreligious, theistic or atheistic, yet viewing the history of our Earth and its inhabitants, and of the whole universe, ...and then going outside of it and recognizing that it is God's *Plan of Creation*, ...I am led with profounder reverence to contemplate this wondrous series of events, caused and controlled by the power and wisdom of the Lord God Almighty.”

Woodrow was fired. He had to weather a heresy trial to maintain his standing as a minister. Ultimately, he recovered to become head of the South Carolina Synod, and eventually President of the University of South Carolina.

John Augustine Zahm (1851–1921) was a Catholic theologian and spokesman on science and religion. He wrote *Evolution and Dogma* (1896). The Catholic Church, which placed more emphasis on church authority, and less on the scriptures did not have the same severe problem with Darwinism as did the Protestants.

In general, Catholics were told they could accept Darwin's theory of evolution, as long as they did not doubt the divine origin of the soul.

Zahm argued that true religion and objective science could never really conflict. Zahm argued that the theory of evolution could actually be found in the writings and sayings of the Church's great Patristic and medieval saints and scholars, such as Gregory, Augustine, Francis of Assisi, and above all Thomas Aquinas! How astounding!

Zahm begins by explaining that Evolution is not a new idea, but a very old idea having its origin in classical Greek philosophers. St. Augustine's teaching – in the beginning God created all things potentially... and that these were afterwards developed through the action of secondary causes during the course of untold ages. St. Thomas Aquinas – Evolution was God's continuing and sustaining power in the birth, growth and development of all creatures He has made. Evolution was what St. Thomas called *Divine Administration*, and what is ordinarily know as Providence.

So Zahm concludes: "To say that Evolution is agnostic or atheistic in tendency, if not in fact, is to betray a lamentable ignorance of what it actually teaches, and to display a singular incapacity for comprehending the relation of a scientific induction to a philosophical – or, more truthfully, an anti-philosophical – system.... Rather should it be affirmed that Evolution, in so far as it is true, makes for religion and Dogma: because it must needs be that a true theory of the origin and development of things must, when properly understood and applied, both strengthen and illustrate the teachings of faith.... The doctrine of Evolution destroys the conception of the world as a machine."⁴⁸

Zahm's conclusion (similar to Woodrow) is that science does not reveal purpose and teleology in nature; and that's OK because religion does.

Finally, Marx was not the only social philosopher to adapt Darwinian biological principles to social processes. Those who adapted Darwin to sociology were known as *Social Darwinists*. The most influential social Darwin philosopher was **Herbert Spencer** (1820–1903), who coined the term *survival of the fittest*.

Spencer published his famous treatise *Social Statics* in 1851 *before* publication of the *On the Origin of Species*. He ultimately became one of the chief popularizers of Darwin and Malthus. Spencer envisioned human progress in terms of the struggle for existence in which the weak fall by the wayside for the greater good of the community.

“The poverty of the incapable, the distresses that come upon the imprudent, the starvation of the idle... are the decrees of a large, far seeing benevolence [which also] brings to early graves the children of diseased parents, and singles out the low-spirited, the intemperate, and the debilitated as the victims of an epidemic.”⁴⁹ said Spencer.

In Spencer’s view, the race is toughened and tempered by the rough and tumble struggle for existence. The strong, intelligent, ambitious, crafty, ruthless, and lucky survive. The weak are purged from the community.

Contrast Spencer’s view of history with Marx. Where Marx believed the downtrodden proletariat would rise up to take control of history, Spencer saw the struggle for existence in which the fittest survived as producing a society which guaranteed maximum opportunity for individuals to fulfill their destiny without encroaching on the rights of others. A good 19th century social theorist, Spencer optimistically believed that social progress was the consequence of the survival of the fittest.

In general, Social Darwinists opposed state interference with the *natural* unimpeded growth of society. This laissez-faire theory was in concert with the traditional capitalist doctrine of Adam Smith. The Government that was best, governed least. This was a good Jeffersonian concept packaged in social science dogma based on Darwinian principles.

Spencer opposed all state aid to the poor, public education, housing regulations, health and safety regulations, tariffs, state banking, and even the government postal system. The government’s principle role was to secure the safety and security of the people from domestic crime and violence and from foreign domination and war. Social Darwinists believed in the privatization of all possible aspects of the society. They had a tremendous distrust of government, and believed that cooperation in an industrial society must be voluntary, not compulsory.

It was a doctrine well suited for industrial capitalism in America, where Spencer became widely popular. Andrew Carnegie was Spencer’s most prominent American disciple. And Carnegie, whose own story was that of rags to riches, an immigrant from Scotland was a generous, humane man. Social Darwinism in America was always tempered by the Social Gospel – an American tradition of private philanthropy. Whatever conclusions one wants to reach about the so-called industrial Robber Barons, many were generous, especially to educational institutions.

During the *Gilded Age* wealthy men founded great universities: Rockefeller and the University of Chicago; Ezra Cornell, Cornelius Vanderbilt, and Leland Stanford, just to name a few. And Carnegie joined the contributors, not only supporting the Carnegie Institute, but funding libraries all across America. This makes his comments about Spencer and Social Darwinism all the more interesting. Carnegie wrote: “I remember that light came as in a flood and all was clear. Not only had I got rid of theology and the supernatural, but I had found the truth of evolution. All is well since all grows better, became my motto, my true source of comfort. Man was not created with an instinct for his own degradation, but from the lower he had risen to higher forms. Nor is there any conceivable end to his march to perfection. His face is turned to the light: he stands in the sun and looks upward.”⁵⁰

John D. Rockefeller was reported to have said : “The growth of a large business is merely a survival of the fittest.... The American Beauty rose can be produced in the splendor and fragrance which brings cheer to its beholder only by sacrificing the early buds which grow up around it. This is not an evil tendency in business. It is merely the working out of a *law of nature and a law of God*.”⁵¹ [emphasis added]



Empowering People. Improving Business.

BI Norwegian Business School is one of Europe's largest business schools welcoming more than 20,000 students. Our programmes provide a stimulating and multi-cultural learning environment with an international outlook ultimately providing students with professional skills to meet the increasing needs of businesses.

BI offers four different two-year, full-time Master of Science (MSc) programmes that are taught entirely in English and have been designed to provide professional skills to meet the increasing need of businesses. The MSc programmes provide a stimulating and multi-cultural learning environment to give you the best platform to launch into your career.

- MSc in Business
- MSc in Financial Economics
- MSc in Strategic Marketing Management
- MSc in Leadership and Organisational Psychology

BI NORWEGIAN BUSINESS SCHOOL

EFMD **EQUIS ACCREDITED**

www.bi.edu/master



William Graham Sumner, a professor of moral philosophy at Yale University, became the chief academic spokesman for Social Darwinism in the United States. Sumner was a dour man. He believed in private charity, but he opposed all government aid equally to the poor or to private business. His book *The Absurd Effort to Make the World Over* (1894) criticized social reform, and in a famous essay he asked rhetorically, “What Social Classes Owe to Each Other.”⁵² The answer: nothing. Sumner also believed in the principle of the struggle for existence. He approved of private charity, but government assistance would create dependency while killing individual and corporate initiative.

Here is a dialogue taken from a student’s notes of Sumner’s class at Yale:

Student: Professor, don’t you believe in any government aid to industries?

Sumner: No! It’s root, hog, or die.

Student: Yes, but hasn’t the hog got a right to root?

Sumner: There are no rights. The world owes nobody a living.

Student: You believe then, Professor, in only one system: the contract-competitive system?

Sumner: That is the only sound economic system. The rest are fallacies.

Student: Well, suppose some professor of political economy came along and took your job away from you. Wouldn’t you be sore?

Sumner: Any other professor is welcome to try. If he gets my job, it is my fault. My business is to teach the subject so well that no one can take the job away from me. Millionaires are a product of natural selection.... Let it be understood that we cannot go outside this alternative: liberty, inequality, and survival of the fittest; not liberty, equality, and survival of the unfittest.

12 Atomic and Nuclear Era (1900–1950)

12.1 Pre-1900 American Science

The Civil War (1861–1865) was a watershed for American science and technology. Northern victory assured a national system of communications and transportation. Medicine as well was significantly advanced by the war. But until about 1930, American science, especially the physical sciences, was a colonial outpost of Europe.

Americans had a little distinction in the 18th and 19th centuries. There was Franklin in electricity and Priestly (who fled to America) in chemistry. And, Audubon in zoology, Lewis and Clark in exploration, and Agassiz and Gray offered distinction to the American scene, but not greatness.

By contrast, American technology was strong and innovative. There was Robert Fulton with his steamboat, Eli Whitney and the cotton gin, Cyrus McCormick invented the mechanical reaper, and Cornelius Vanderbilt built a fortune with ferry boats and steamships. Frederick Howe planned and built cities, and Samuel Colt patented the revolver and made its manufacture a commercial success. Perhaps the most important *American* contribution to technology before 1860 may have been *balloon frame* housing construction. This allowed houses and barns to be built in a single day and provided homes for the population which expanded across the country following the Civil War.

In America, basic science research largely lacked patronage. In Europe, science enjoyed increasing government and private support. Concurrently, sciences in Europe had developed levels of professionalism (including scientific organizations), specialization, and University Graduate Education.

European universities, especially in Germany and England became the centers for research in the physical sciences. As late as the 1920, Americans largely depended on European universities for doctoral studies in the sciences. America's inner circle of scientists – including Louis Agassiz (Harvard biologist), Alexander Dallas Bache (Head, Coast and Geodetic Survey), and Joseph Henry (Head, Smithsonian Institution) promoted European professionalism, academic science, and campaigned against amateurism. This group called themselves the *Lazzaroni* (beggars), and founded the American Association for the Advancement of Science (AAAS) in 1847. The Lazzaroni ardently promoted the German concept that scientific research was an essential function of college faculties.

Yale University founded a Graduate School and awarded the first Ph. D. in the New World in 1861. Johns Hopkins was founded in Baltimore in 1876 as a university where one could study a *research* oriented Ph.D. in Science. Two major developments arising out of the Civil War would ultimately change the face of American science. First, the Morrill Land Grant Acts (1862 and 1890) established the national state university system devoted to research in agriculture, engineering, technology, and science. The first Act gave land for a state university and the second Act established experiment stations in agriculture and engineering. (The second Act also required co-education.) Second, the National Academy of Sciences was established in 1863 to serve as an official science advisor to the federal government – although it was largely ignored until the 20th century and often even then.

While America lagged in science between 1865–1895, the United States became the world leader in applied technology. In America technology seemed to plunge ahead without scientific trail-blazing. But even industry did not completely ignore basic science.

Thomas Edison (1847–1931) established his research laboratory at Menlo Park, NJ, in 1876. Edison's research laboratory became a prototype of the industrial laboratory for which the United States would become a world leader. It established precedents for great industrial research labs of such giants as GE, AT&T, Bell Labs, Westinghouse, and IBM.

Need help with your dissertation?

Get in-depth feedback & advice from experts in your topic area. Find out what you can do to improve the quality of your dissertation!

Get Help Now



Go to www.helpmyassignment.co.uk for more info



Helpmyassignment



Click on the ad to read more

Prior to World War II, U.S. government laboratories were neither large nor important. In part this was because of the Government's *benign neglect* of science. (The U.S. would have no real science policy until WW I.) Without strong support from the government, science in the United States became decentralized and pluralistic, and mostly supported by economic interests. For example, the government did establish some small research laboratories to do research on coal and oil. The U.S. Department of Agriculture sponsored some research on plants, animals, and insects at the newly founded land-grant universities; the military, especially the Navy, conducted weapons related research on ballistics, explosives, armament, and related matters. (On a recommendation to congress from Thomas Edison, the U. S. founded the Naval Research Laboratory in 1923.)

In the 1880s, a congressional appointed commission recommended the establishment of a Department of Science, but Congress rejected the idea. Yale produced a great physicist in Josiah Willard Gibbs. And, the American Chemical Society was founded in 1876. Physics, chemistry, and medicine were becoming the principle interests of American scientists.

12.2 Theories of the Aether

Clerk Maxwell in 1865 had calculated electromagnetic waves would travel about 299,793 kilometers per second (186,000 mps) – the speed of light! According to Newtonian mechanics, waves traveling through space required a mechanical medium. But, an evacuated chamber that could not convey sound, conveyed light. Therefore, the Aether, an ancient concept as old as Aristotle, was assumed to exist and be the medium through which light traveled.

Albert Michelson (1852–1931) and **William Morely** (1838–1923) believed that one ought to be able to detect the aether wind. They reasoned that either the Earth was moving through the aether, which pervaded all space, or that the aether was flowing past the Earth. Either way (in this relativistic movement), one ought to be able to detect the speed of the Earth through the aether – like a giant boat moving through water.

In 1887, Michelson and Morely built an interferometer to send two beams of light, one in the direction of Earth movement and the other perpendicular to the first, to determine if there was a difference in their speeds. However, no difference was measured no matter which way the instrument was turned. (See Link 12.1.)

Link 12.1 Interferometer

<http://hyperphysics.phy-astr.gsu.edu/Hbase/phyopt/michel.html>

What did this puzzling result mean? Had Newton been wrong? Seventeen years would pass before young Albert Einstein would answer these questions. (Michelson received a Nobel Prize for this work in 1907.)

It was the end of the century (*Fin de Siecle*). Optimism prevailed. Everywhere reformers believed the principles of science and good government would usher in an era of *Progress and Prosperity*.

Europe had generally been at Peace since the Congress of Vienna (1814–15), and while America had passed through the trauma of Civil War, many believed that general war was a thing of the past, unthinkable for modern civilized nations. The technology of warfare was such that no sane national leaders would lead their people into armed conflict.

Shortly after the turn of the 19th century science and engineering gave the world electric lights, the telephone, phonograph, automobile, aeronautics, X-rays and the radio. All of these captured the imagination and produced renewed faith in progress through technology. Rapidly growing transportation and communication systems, and chemical and electrical products, especially in Germany and the United States, created a general prosperity that also encouraged greater political freedom and democracy.

Women, too, demanded participation in the political process. In 1896 the first modern Olympic Games were held in Athens, Greece. In 1901 the first Nobel Prizes were offered for scientific accomplishment. Soon the 19th amendment (ratified in 1920) would give women the right to vote.

There was some pessimism as reflected in the writings of Henry Adams and others. Darwin had challenged humanity's special place in nature. Thermodynamics predicted the collapse of civilization. Freud and Nietzsche noted the irrationality of human affairs. Ethnic rivalries and hatreds had erupted into murderous violence in Southeastern Europe. Anti-Semitism, thought a thing of the past in modern, progressive Europe, arose in France, Germany and elsewhere. In a few years there would be WW I.

12.3 X-Rays and Radioactivity

In 1879, British scientist William Crookes (1837–1919) built an evacuated tube with an electrode at each end to study electric discharges in gases. (See Link 12.2.)

Link 12.2 Crooke's Tube

<http://bit.ly/14hBeP7>

When a high voltage was applied to the electrodes, Crookes observe a beam of yellow rays coming from the cathode (negative electrode). The more he evacuated the tube, the brighter his *cathode rays* became. A porous screen placed inside the tube would let the rays go through. And, cathode rays could also be bent by a magnet in a direction that showed they were negative.

In 1895, **Wilhelm Röntgen** (1845–1923), a German physicist, was experimenting with a Crookes's Tube when he noticed a zinc sulfide screen glowing across the room. When the tube was turned off, the glow disappeared. Röntgen repeated the experiment and placed materials between the tube and the screen noting that it took a lot of solid matter to completely stop the interaction. (See Link 12.3.)

Link 12.3 X-Rays

<http://bit.ly/14UxhLW>

Röntgen named the rays that travelled from his Crooke's tube X-Rays, the X standing for *unknown*. Röntgen brought his wife to the laboratory and placed the Crooke's tube on a stand with a photographic plate beneath his wife's hand. (See Link 12.4.)



Brain power

By 2020, wind could provide one-tenth of our planet's electricity needs. Already today, SKF's innovative know-how is crucial to running a large proportion of the world's wind turbines.

Up to 25 % of the generating costs relate to maintenance. These can be reduced dramatically thanks to our systems for on-line condition monitoring and automatic lubrication. We help make it more economical to create cleaner, cheaper energy out of thin air.

By sharing our experience, expertise, and creativity, industries can boost performance beyond expectations. Therefore we need the best employees who can meet this challenge!

The Power of Knowledge Engineering

Plug into The Power of Knowledge Engineering.
Visit us at www.skf.com/knowledge

SKF

Link 12.4 X-Ray Photograph of Mrs. Röntgen's Hand

<http://bit.ly/17ICSrU>

The developed photographic plate showed the bones of Mrs. Röntgen's hand in detail and showed her wedding rings as well. In less than a year, X-rays were being used in Chicago for medical purposes, particularly to discover bone fractures and to determine alignment for setting broken bones. Röntgen received the first Nobel Prize in physics (1901) for his remarkable discovery.

Henri Becquerel (1852–1908) was the son and grandson of physicists. Both his ancestors had been well known in their day. Becquerel pursued research on Röntgen's X-rays. Röntgen had determined that X-rays fogged a photographic plate. Becquerel tried to establish that there was a relationship between X-rays and light. It had been discovered that certain salts and crystals became dramatically fluorescent when X-rays were shined on them.

In 1896, Becquerel wrapped a uranium-salt crystal along with a photographic plate in black paper, placed it on his window sill, and determined that no matter how much black paper he wrapped around the crystal, light somehow penetrated to activate the salts and leave a black spot on the photographic plate.

One day it rained and Becquerel placed a freshly wrapped bundle of uranium-salts along with a photographic plate in his desk drawer. Several days passed before there was clear weather again in Paris. Finally, Becquerel got a chance to expose his bundle to sunlight, but when he developed the photographic plate, he discovered results far different from before. Instead of faint dark impressions, he discovered a heavy dark spot, only possible after extended exposures, perhaps of several days. The uranium salts had exposed the photographic plate! (See Link 12.5.)

Link 12.5 Becquerel's Photograph of Uranium Salts

http://www.vias.org/physics/img/becquerel_plate.jpg

Becquerel heated the uranium, froze it, ground it up, and dissolved it in acid, but the results were always the same. The rays he discovered had nothing to do with sunlight but emanated from the uranium itself!

Becquerel had discovered an unbelievable property of matter. The uranium continuously emanated rays that were very penetrating just like the X-rays of Röntgen. In 1896, Becquerel had discovered radioactivity. (Becquerel shared the 1903 Nobel Prize in physics with Pierre and Marie Curie for the discovery of radioactivity.)

Another startling discovery occurred only a few months later. **J.J. Thomson**, an English scientist, (1856–1940) declared in 1897 that cathode rays were negative pieces of atoms. (The electron was the first subatomic particle.) Dalton's immutable atoms were actually made of parts! We will talk about the implications of Thomson's identification of cathode rays a little later. However, it is interesting to note that Thomson was able to calculate the mass of the electron by the extent that it curved in a magnetic field. Thomson's calculation of the electron mass as about 1/2000th that of a hydrogen atom is only about 10% off. (Thomson won the 1906 Nobel in Physics for the discovery of the electron.) (See Link 12.6.)

Link 12.6 Thomson's Discovery of the Electron

<http://bit.ly/181SbKU>

Thomson realized the cathode rays (traveling from the cathode to the anode) had to be negative and had to be particles coming from the atoms in the cathode. He placed a magnet around the beam and it bent in the correct direction for negative particles. From the voltage of the tube, Thomson calculated the velocity of the negative particles, and from the strength of the magnetic field and the curvature of the beam, he could calculate the mass of the particles. (An Irish physicist, George Johnstone Stoney, had suggested in 1891 that he could explain electroplating if atoms could be broken apart. Stoney coined the term *electron* at that time.)

Following Becquerel's discovery, **Marie Curie** (1867–1934), and her husband Pierre, devoted themselves to the study of the strange phenomena of radioactivity. (It is interesting to note that Marie was Pierre's student. She came to Paris to study because her native Poland did not let women go to college at that time.)

The most dramatic question regarding radioactivity was how energy could be continuously emitted from matter without any outside source such as light, heat, or electricity? The Curies literally gave their lives to the pursuit of this question. From 1896 to 1898 they separated several tons of pitchblende into its chemical components finding that one precipitate (with bismuth) became more and more radioactive. In June 1898 they announced that they thought a new element had been discovered. They suggested the name *polonium* to honor Marie's home country of Poland.

Their work continued and by December 1898 they announced another new element, this one similar to barium. *Radium*, which was much more radioactive than uranium or polonium, had been discovered. They isolated about 25 mg which was about 1/4 of the total amount of radium in the tons of pitchblende. (This is about 1 part in 10^8 or 10 parts per billion. If you lay golf balls all the way around the equator and replace one with a ping pong ball you have 1 ppb. But the Curies were looking for atoms, not golf balls!)

The work of the Curies was very significant in showing there were radioactive elements other than uranium. And, the energy output of radium was very high, so much so that it was always warmer than the surrounding environment. The Marie Curie called this effect radio-activity. Here was the possible answer about the age of the Earth. Radioactive ores could account the Earth cooling more slowly and give a much longer age to the Earth.

TURN TO THE EXPERTS FOR **SUBSCRIPTION** CONSULTANCY

Subscribe is one of the leading companies in Europe when it comes to innovation and business development within subscription businesses.

We innovate new subscription business models or improve existing ones. We do business reviews of existing subscription businesses and we develop acquisition and retention strategies.

Learn more at [linkedin.com/company/subscribe](https://www.linkedin.com/company/subscribe) or contact Managing Director Morten Suhr Hansen at mha@subscribe.dk

SUBSCR✓**BE** - to the future

Ernest Rutherford (1871–1937) was born in Nelson, New Zealand and studied at Cambridge under J.J. Thomson. Rutherford graduated in 1897 and accepted a chaired position at McGill University in Canada in 1899. Working with **Frederick Soddy** (1877–1956) Rutherford determined there were different rays produced by radioactive substances. Alpha rays could be stopped by a sheet of paper, Beta rays could pass through aluminum foil, and Gamma rays behaved very much like X-rays). Rutherford determined that the radioactive element thorium gave off a radioactive gas, as did uranium, which the Curies confirmed. Rutherford and Soddy analyzed the gas and determined that it had no chemical character whatever. It was inert. In a clever experiment, Rutherford collected the gas and learned that it lost its radioactivity after several minutes. By quantifying the results he found that the gas lost one-half its radioactivity in 62 seconds. Rutherford had discovered that radioactive materials are characterized by an important property called its half-life. We now know that radioisotopes have half-lives ranging from less than a microsecond to more than a billion years.

Using magnetic and electrostatic effects, it was now possible to determine that alpha particles were helium nuclei, beta particles were merely very energetic electrons, and gamma rays were high energy light. (See Link 12.7.)

Link 12.7 Alpha, Beta and Gamma Radiation

<http://library.thinkquest.org/28383/grafika/1/aalfa-beta-gamma.gif>

In sum, radioactive thorium was spontaneously transmuting itself into another element! (This was the dream of the alchemists as they sought the philosopher's stone – transmutation of elements!) What does this mean for classical Newtonian mechanics? In 1907, Rutherford became the Langworthy Professor at the University of Manchester in England and then the Cavendish Professor at Cambridge succeeding his mentor, Thomson. We will shortly discuss his most famous experiment which was carried out at Manchester.

Let's take a moment to move forward in time and see some of the tools that radioactive phenomena have given us. In 1947, Willard Libby, at the University of Chicago developed radiocarbon dating. Radioactive carbon-14, with a half-life of 5730 years, is produced in the upper atmosphere by cosmic radiation. The radioactive carbon eventually becomes carbon dioxide and is ingested by plants. Since plants are basic in the food chain for animals, all living matter has a steady ratio of radioactive carbon to normal carbon.

However, when the plant or animal dies, its ingestion of carbon-14 stops, and the ratio of carbon-14 to normal carbon decreases to half its amount every 5730 years. By measuring the ratio of carbon-14 to normal carbon, formally living matter can be dated back to about 60,000 BCE with an accuracy of +/- 100 years. For example, the Shroud of Turin was dated independently at Oxford, Zurich, and the University of Arizona and was found to be made from fabric produced from vegetable matter from 1260–1390 CE.

Potassium-Argon dating is used for rocks. Potassium-40, which is naturally occurring, has a half-life of 1.3 billion years. As it decays to the gas argon, the gas escapes from the molten rock. But, once the rock solidifies the argon is trapped. By measuring the argon-potassium ratio, it is possible to date rocks to billions of years. We will talk more about dating methods in chapter 19.

12.4 Atomic Structure

Albert Einstein (1879–1955) was born in 1879 in Ulm, South Germany. He was the son of Jewish parents. His father was an unsuccessful businessman and Einstein's family moved frequently. He was raised in a free-thinking household, his father was little concerned about Jewish religion or tradition. (We commented earlier that Newton was born the year that Galileo died. And, Einstein was born the year that Maxwell died.)

Young Albert was late in learning to talk – almost three years old. He was never a fluent child. Einstein's parents even worried that their son might be retarded. He recalled being very impressed by a compass his father gave to him when he was five. He wondered how something like the compass needle could be moved when nothing touched it.

At age 12, he was enthralled with a book on plane geometry. He seems to have had very typical male left-brain dominance. He learned to play the violin when he was six, and remained a competent amateur musician all his life. Einstein attended a Catholic grade school, where he became deeply interested in religion and ethics, an interest that he retained the rest of his life.

After grade school, he enrolled in a secondary school, or gymnasium, but soon dropped out to join his parents in Milan, where his father suffered another business failure. In 1895, at age 16, because of deficiencies in history, literature, and languages, he failed the entrance examination to the Polytechnic School in Zurich, where he had hoped to study to become an electrical engineer. After a year of studies at a local preparatory school, he was admitted to the Polytechnic School, which was the equivalent of MIT or Cal. Tech.

Einstein became a student of H.F. Weber, a noted electrical engineer. He did well at the Polytechnic School, but changed his major from engineering to education to secure a certification to teach secondary school math and physics. The free-spirited Einstein may have had some problems with Weber, a rather traditional disciplinarian. While a student, he fell in love with Mileva Maric', a young Serbian woman who also studied physics at the Polytechnic School.

Einstein's family strongly opposed their marriage, and in 1901 Mileva became pregnant and gave birth to a daughter who was given up for adoption. Only later did Einstein's family relent in their opposition to his love-affair with Mileva.

After he graduated in 1900, Einstein's career was headed nowhere. This could have been related to Einstein's life style, his challenge to authority, and anti-Semitism. Weber did not support Einstein for teaching positions or graduate assistantships. Weber also flunked Mileva on her exams and she left the Polytechnic without receiving her degree.

For the next three years, Einstein lived a discouraging life of temporary appointments and tutoring while trying to pursue doctoral studies. Without an advisor or sponsor, his doctoral dissertation submitted to the University of Zurich did not succeed, and, in 1902, he withdrew from the university. That year his father died.

Sponsored by a relative, Einstein secured a permanent position in the Swiss Patent Office as an entry-level patent examiner, *Technical Expert – Third Class*. He and Mileva finally married and in 1904, a son was born. By 1905, Einstein had a wife and family, a full-time civil service job, and a comfortable apartment in Bern.

As we discussed earlier, Isaac Newton had his *Annus Mirabilis* in 1666 around the age of 22. And, for Albert Einstein, his *Annus Mirabilis* came in 1905 around the age of 26. In a few short months, Einstein submitted five papers to *Annalen der Physik*, at least three of which were worthy of the Nobel Prize.



What do you want to do?

No matter what you want out of your future career, an employer with a broad range of operations in a load of countries will always be the ticket. Working within the Volvo Group means more than 100,000 friends and colleagues in more than 185 countries all over the world. We offer graduates great career opportunities – check out the Career section at our web site www.volvogroup.com. We look forward to getting to know you!

VOLVO
AB Volvo (publ)
www.volvogroup.com

VOLVO TRUCKS | RENAULT TRUCKS | MACK TRUCKS | VOLVO BUSES | VOLVO CONSTRUCTION EQUIPMENT | VOLVO PENTA | VOLVO AERO | VOLVO IT
VOLVO FINANCIAL SERVICES | VOLVO 3P | VOLVO POWERTRAIN | VOLVO PARTS | VOLVO TECHNOLOGY | VOLVO LOGISTICS | BUSINESS AREA ASIA



In **March**, Einstein submitted a paper which was the first argument for the quantum structure of light. In this paper he explained the *photoelectric effect*. When low frequency light toward the red end of the spectrum is shined on the cathode no current travels in the circuit. But, when higher frequency light toward end violet end of the spectrum is used a current flows. From this, Einstein determined that the energy of light was proportion to its frequency ($E = h\nu$, where h is Planck's constant and ν is the frequency) and light behaves as particles. (He won the Nobel Prize for Physics in 1921 for this work.) (See Link 12.8.)

Link 12.8 Photoelectric Effect

<http://bit.ly/16AmT01>

In **April**, he gave a theoretical method for calculating the number and size of molecules from their motion in solution. This article was accepted as a doctoral thesis by the University of Zurich.

In **May**, he submitted an explanation for the erratic motion of small bodies suspended in liquids (*Brownian motion*). This was the first experimental evidence of the existence of atoms. The argument of continuous matter versus atomic matter continued until this time. (See Link 12.9.)

Link 12.9 Brownian Motion

http://www.pitt.edu/~jdnorton/Goodies/Einstein_stat_1905/Brownian%20motion%20anim.gif

In **June**, he submitted a paper entitled *On the electrodynamics of Moving Bodies*. This was the special theory of relatively involving new concepts of space, time, and mass. (See Link 12.10.)

Link 12.10 Special Relativity

<http://bit.ly/13PWqs1>

In **September** he presented a three-page paper that derived his famous formula $E=mc^2$, that energy and matter were equivalent and could, theoretically, be converted from one to the other. This will become the basis for explaining radioactivity and for the development of nuclear power and nuclear weapons.

How did he do it? What did it mean? As we shall see, the world will never be the same.

A new era of science had been launched. The world of sub-atomic science had been born. The electron had been discovered eight years earlier bringing an end to Dalton's immutable atoms. Next, with the discovery of radioactivity, energy was available from within atoms, energy that had no apparent relationship to thermodynamics. Did this mean *conservation of energy* was wrong? Newtonian physics was suffering blow after blow, as was the credibility of science. The electron had already been discovered and the addition of radioactivity suggested that Dalton's immutable atoms might be composed of parts.

Lavoisier had taught that mass is conserved in all reactions. Joule had taught that energy is conserved in all reactions. But now Einstein tells us that mass can be converted to energy and, presumably, vice versa. In effect, Einstein has told us that it is the combination that is conserved. So, if we simply consider mass another form of energy, then we can make our rule that energy is conserved.

$E = mc^2$ gives us the answer to some very important questions. First, this relationship answers the question as to the source of energy in radioactivity. (We will shortly calculate how a small quantity of matter can be converted into a huge amount of energy.) By explaining radioactivity, we can explain why the Earth can be much older, old enough for uniformitarianism and evolution to work. Radioactive material within the Earth slows the cooling process. Furthermore, we finally have an explanation for the tremendous amount of energy that pours from the sun and other stars. And, the Einstein relationship opened up an entirely new and very large source of energy, that being mass.

To put mass-to-energy equivalence on a practical scale, consider the following: In 2007, the world energy consumption of energy was about 5×10^{20} Joules. Total conversion of 1 kg (2.2 lbs) of matter to pure energy yields about 1017 Joules. Therefore, 5000 kg (5 metric tons or 11,000 lbs) of matter would supply the entire world's energy needs for an entire year. (In 1919, when Aston invented the mass spectrometer that could measure isotopic masses accurately, the Einstein equation predicted both nuclear fusion and nuclear fission.)

The discovery of the electron and radioactivity led to research in the structure of the atom. Since it could be determined that electrons were negative by the direction of their curvature through a magnetic field, the rest of the atom had to be positive. Also, the very low mass of the electron, about $1/2000^{\text{th}}$ of the mass of a hydrogen atom, meant that the positive mass had to be very heavy. J.J. Thomson proposed a *plum-pudding* model of the atom in which there was positive matter spread over the atom with electrons stuck in the atom like seeds in plum-pudding. (I always thought of Thomson's proposal as the watermelon model.) (See Link 12.11.)

Link 12.11 "Plum Pudding" Atom

<http://www.doe.mass.edu/mcas/images/db/07chemHSq25.gif>

In order to find the positive mass, Rutherford conceived a remarkable experiment (1907–1911). In Rutherford's experiment, alpha particles, now known to be helium atoms lacking their electrons, were allowed to bombard a thin film of gold and the angles of scattering measured. To Rutherford and his students' shock – his students were named Geiger and Marsden, both later to become famous – very few alpha particles were deflected. However, those deflected were scattered at wide angles – some even reflected backwards. (See Link 12.12.)

Link 12.12 Rutherford Scattering Experiment

<http://bit.ly/16J9l4M>

Rutherford solved the mathematical scattering equations and was able to conclude that all the positive charge was compressed into a very small area. Rutherford, with his crude experiment but great insight, had discovered the nucleus of the atom. He had also determined that it was positive by the fact that some of the alpha particles, themselves positive, were scattered backwards.

gaiTeye[®]
Challenge the way we run

**EXPERIENCE THE POWER OF
FULL ENGAGEMENT...**

.....

**RUN FASTER.
RUN LONGER..
RUN EASIER...**

**READ MORE & PRE-ORDER TODAY
WWW.GAITEYE.COM**

The advertisement features a runner in a red shirt and black leggings on a dirt path at sunset. Technical diagrams, including a dotted line and a circular diagram with lines, are overlaid on the runner's feet. A yellow button with a hand cursor icon is located in the bottom right corner of the ad.

Now the race was on to solve the mechanics of the atom with its light, negative electrons that were easily pulled off and its heavy positive nucleus. The idea of negative electrons orbiting a positive nucleus was obvious and, unfortunately, also wrong.

In another important development, Englishman Henry Moseley found X-ray energies correlated with the number of electrons in a given element. Roughly, the heavier the element, the more energetic X-rays it produced. This made it possible to assign the correct atomic number to each element. (The atomic number is the number of positive charges, or protons, in the nucleus. It is the same as number of electrons in the neutral atom.) Moseley's atomic numbers agreed exactly with Mendeleev's ordering of the elements by atomic weight and chemical intuition. What a wonderful confirmation of 19th century chemistry this was. (See Link 12.13.)

Link 12.13 Correlation of X-Ray Energy and Atomic Number

<http://bit.ly/16J9oh7>

Pushing the frontier ever further, **C.T.R. Wilson** (1869–1959), working in J.J. Thomson's laboratory, invented the cloud chamber in 1912, a device which allowed the tracking of radioactive events. This device has probably been the most important experimental tool of nuclear physics. Wilson won the 1927 Nobel Prize in Physics for this development. (See Link 12.14.)

Link 12.14 Cloud Chamber Tracks

http://www.scienceclarified.com/images/uesc_03_img0160.jpg

In 1913, J.J. Thomson sent a beam of charged neon atoms through a magnetic field and discovered that they consisted of two different masses. Later, Francis Aston (1877–1945) in 1919 through 1922 developed the instrument now known as the mass spectrometer for investigating the masses of atoms. The combined efforts of Thomson and Aston determined that many elements had one or more stable isotopes, that is, nuclei with different masses. For example, oxygen has three and tin, of all things, has ten, the most of any element.

The initial interpretation was that some elements had additional protons in the nucleus whose charge was cancelled by electrons also in the nucleus. Carbon, atomic number 6 with 6 electrons, has three isotopes that occur in nature. They are called ^{12}C , ^{13}C , and ^{14}C . (^{14}C is actually radioactive but has a long half-life.) The explanation at that time was that ^{12}C had 6 electrons outside the nucleus, 12 protons and 6 electrons inside the nucleus. ^{13}C then had 1 more proton and 1 more electron in the nucleus. The other possibility was that there was a neutral particle with just about the same mass as the proton.

James Chadwick (1891–1974) found the neutral particle, called the neutron, in 1932, by correctly interpreting a clever nuclear experiment done in Marie Curie's laboratory by her daughter Irene Curie-Joliot. Rutherford had predicted the neutron in 1932 and Chadwick was working as Rutherford's research assistant at the time of his discovery.

Two German scientists had discovered that when beryllium was hit by alpha particles it emitted a neutral radiation that was very penetrating. Marie Curie's daughter, Irene Joliot-Curie and her husband Frederic and Chadwick did similar experiments letting the penetrating rays collide with other atoms. However, the Joliot-Curie team did not interpret their results correctly.

Chadwick discovered that various elements absorb the penetrating rays and released other radiation. His calculations showed that this could only happen if the penetrating radiation was neutral and about the same mass as a proton. Thus, he concluded that the radiation was neutrons. Chadwick received the 1935 Nobel Prize in Physics for the discovery of the neutron.

Thomson first used magnetic deflection to measure the masses of charged particles. However, the device that is called the mass spectrometer was developed properly by Aston a few years later so it seems appropriate to give them both credit. Aston received the 1922 Nobel Prize in Chemistry for the mass spectrometer. The mass spectrometer is still, in my opinion, the most important instrument in analytical chemistry today. Molecules are vaporized and ionized by a number of methods and their charge to mass ratios measured to identify the fragments.

Going back to our example of ^{12}C , and ^{13}C , ^{12}C has 6 electrons, 6 protons and 6 neutrons, while ^{13}C has 6 electrons, 6 protons and 7 neutrons. Isotopes are simply different numbers of neutrons with the same number of protons. Hence, the difference between ^1H , ^2H (deuterium, sometimes symbolized as D) and ^3H (tritium, sometimes symbolized as T) is that the first has a nucleus with a single proton, deuterium has a nucleus of a proton and a neutron and tritium has a nucleus of a proton and two neutrons. All have only a single electron. Since the *chemistry*, that is the formation of molecules and their reactions, is caused solely by the charged particles and is only very slightly influenced by their differences in weight, *all isotopes of a given element have similar, almost identical, chemical behavior but radically different nuclear behavior.*

12.5 Nuclear Fusion and Fission

The Einstein relationship, $E = mc^2$ ($1 \text{ kg} = 9 \times 10^{16} \text{ Joules}$), combined with accurate mass information, allows a thermodynamic calculation as to what will happen when nuclei are combined (nuclear fusion) or fractured (nuclear fission). The mass of a proton, m_p , is $1.673 \times 10^{-27} \text{ kg}$; of a neutron, m_n , is $1.675 \times 10^{-27} \text{ kg}$; and an electron, m_e , is $9.110 \times 10^{-31} \text{ kg}$. Carbon-12 has 6 protons, 6 neutrons, and 6 electrons. As separate particles, their total mass is $2.009 \times 10^{-26} \text{ kg}$. However, the mass of a carbon-12 atom is only $1.993 \times 10^{-26} \text{ kg}$. This small mass difference is the mass lost in the formation of the nucleus and, when converted to energy, produces $1.44 \times 10^{-11} \text{ Joules}$. Since there are 12 nucleons (protons and neutrons), the energy per nucleon is $1.2 \times 10^{-12} \text{ Joules}$. This is about $6 \times 10^{10} \text{ Joules}$ for the formation of one gram of carbon-12. (There are 453.6 grams in a pound.)

As we go across the period table the so-called binding energy per nucleon increases to a maximum and then decreases again. The following table gives values from near the ends of the periodic table and the middle. (See Table 12.1 and Link 12.15.)

Isotope	Symbol	B.E. per nucleon (Joules per nucleon)
Carbon-12	^{12}C	1.26×10^{-12}
Iron-56	^{56}Fe	1.43×10^{-12}
Uranium-235	^{235}U	1.23×10^{-12}

Table 12.1: Binding Energies of Isotopes

This e-book
is made with
SetaPDF





SETASIGN

PDF components for PHP developers

www.setasign.com

Link 12.15 Binding Energy vs. Atomic Number

<http://www.splung.com/nuclear/images/benergy/benergy.png>

The most naturally abundant isotope of iron, ^{56}Fe , is the most stable isotope because it has the highest binding energy per nucleon. i.e. the most energy is released by forming ^{56}Fe . Einstein's equation tells us that fission should occur with nuclei above ^{56}Fe and that fusion should occur with nuclei below ^{56}Fe . Huge amounts of energy would be released in either process.

Nuclear fusion can be achieved by combining two ^2H nuclei to form a ^4He nucleus. (^2H is called deuterium and given the special symbol D. The sun is about 71% hydrogen and 27% He, by mass.)

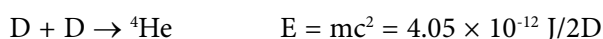

This means that 1 pound of D (1.4×10^{26} atoms) would produce 2.7×10^{14} Joules of energy. [$m(\text{D}) = 3.346 \times 10^{-27}$ kg and $m(^4\text{He}) = 6.647 \times 10^{-27}$ kg.]

But, it requires very energetic particles to overcome the repulsive Coulomb force and bring two nuclei close enough together for fusion to occur. (Remember, both nuclei are positively charged.) A temperature of about 10^6 (one million) degrees must be reached before a fusion reaction can begin. While fusion bombs have been built, no one has yet been able to build a containment system for a fusion reactor. Hence, we do not yet have fusion power. (Fusion would be an incredible power source for the world. ^2H or deuterium is the fuel and 1% of naturally occurring hydrogen is deuterium. Water is about 22% hydrogen by weight and there is a lot of water in the ocean!)

Nuclear fission, on the other hand, can occur spontaneously, or when a neutron is captured by a heavy nucleus. Fission was first achieved with by bombarding ^{235}U with neutrons. (^{235}U is about 0.7% abundant in naturally occurring uranium.)

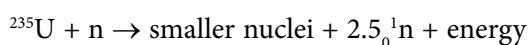

Given a critical mass of ^{235}U , enough so that each fission produces exactly one more fission, once begun a chain reaction occurs and a fission+ reaction runs continuously. (In addition to the amount of fissionable material, the configuration or geometry of the material is important to achieving a critical mass. A spherical geometry is the ideal.) In the next chapter we will discuss how critical masses were achieved to build the first nuclear weapons.

12.6 Special Relativity

Aristotle's and Newton's space and time were absolute. If time is absolute, then there must be a *clock of the Universe*, that is, time must be independent of your frame of reference.

Consider the following thought experiment, if we stand one light-hour apart (that is the distance that it takes light one hour to travel, about 6.4×10^8 miles), when your watch says 3:00 PM, I see it reading 2:00 PM. If, in the next hour as seen by you, we move the distance equivalent of 30 light-minutes towards each other, when you read your clock as 4:00 PM, I read it as 3:30 PM! Therefore, if I try to measure time using your reference frame, it seems to move more slowly for me, than it seems to move for you! (The experiment would have the same results for you trying to measure time using my reference frame.) (See Figure 12.16.)

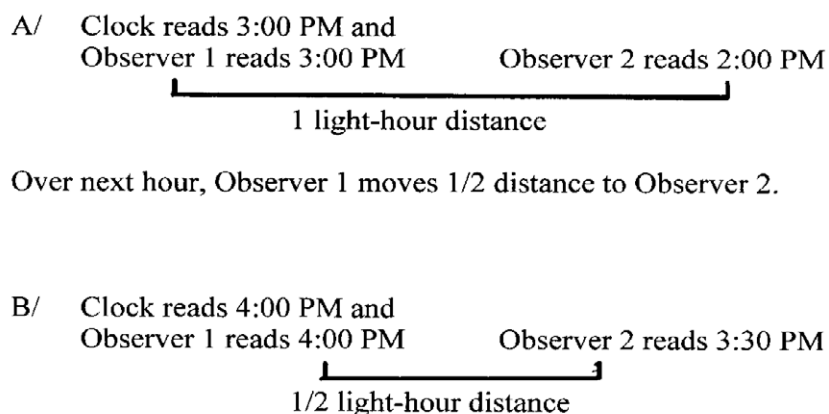

Figure 12.16 Clocks Moving Towards Each Other

Since light takes a finite time to travel, we can never establish the simultaneity of events. Hence, *there is no clock of the universe and time depends upon your frame of reference!*

The paper Einstein submitted in June, 1905, *On the Electrodynamics of Moving Bodies*, has two special assumptions: 1) The laws of physics are invariant in all inertial reference frames; and 2) It is a law of physics that the speed of light in a vacuum is the same in all inertial reference frames, independent of the speed of the source or detector of light.

The first principle virtually assumes that physics exists, i.e. that there are laws to the universe and they are the same in all inertial reference frames. The second agrees with the Michelson-Morley experiment and, in effect, says that no aether can ever be detected because there is no way to measure a difference of the speed of light in vacuum. (The speed of light in any medium is less than that in vacuum. The ratio of speed of light in vacuum to that in a medium is called the index of refraction.)

Consider what the constancy of the speed of light would do with a person standing in the middle of a train car and shining a light at the two ends of the cars. The light would be seen to hit the walls at the same time. However, to an observer watching the train move by, the light would hit the ends at different times! (These are difficult experiments to consider. Keep trying if you find them hard.)

Consider two identical clocks moving away from each other. Einstein showed that the relationship between the times in the two frames of reference was $t' = t(1 - \beta^2)^{1/2}$ where $\beta = v/c$, t' and t are the times, v is the velocity between the two clocks and c is the speed of light.

Einstein, in effect, showed that space and time were interchangeable. And, that the only correct measurement of any event, is space-time. This led to the same form of expression with which the Dutch physicist, Hendrik Lorentz, had explained the Michelson-Morley experiment, only the results of which we will discuss here. Henri Poincare, a French theorist, had suggested in 1904 that it was useless to try to measure the movement of the Earth, or anything else, with respect to the aether.

The result of the space-time equations (as shown through the mathematics of, once again, Pythagoras) is a series of equations in which a multiplying factor is $(1 - \beta^2)^{1/2}$, where β is v/c , the speed of light of the object divided by the speed of light in a vacuum.

Free eBook on Learning & Development

By the Chief Learning Officer of McKinsey

[Download Now](#)

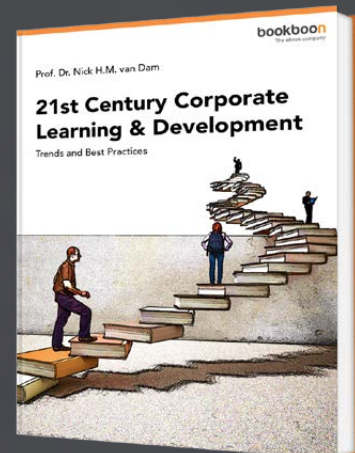

As a body is accelerated towards the speed of light, its relativistic mass increases as divided by this factor, so: $m = m_0 / (1 - \beta^2)^{1/2}$ where m_0 is the rest mass. (Light has no rest mass, only a relativistic mass.) When $v = c$, mass becomes infinite! Therefore, as energy is applied to accelerate a particle, it becomes heavier. And, more and more energy must be used to provide the additional acceleration. This additional mass agrees with the Einstein equation, $E = mc^2$. Also, as a body moves closer to the speed of light, time in that reference frame becomes slower compared to external reference frames. (This is the result of the General Theory of Relativity and involves acceleration.) While only relative velocity can be known between two objects in different inertial frames, acceleration can be measured within a frame. (This gives rise to many forms of optical illusions.)

The twin paradox is an interesting example of time dilation. If a twin were to travel very rapidly in a space ship, say at 99.9% of the speed of light to another star 100 light-years away and return, that twin would age only 9.94 years while the twin that stayed behind aged 200 years! Further, it would seem to the first twin that the distance to the other star was only 4.47 light-years. (See Link 12.17.)

Link 12.17 Twin Paradox

<http://bit.ly/17ID8XV>

Consider also the cosmological results of the speed of light being constant. We know only the past of the universe. And, since so much is so far away, we know only the ancient past.) The speed of light constancy is verified by experiments with the *redshift*. If the speed remains constant, then, as an object moves towards us, the frequency of light should increase and, as it moves away, should decrease. This is observed and, in fact, used to calculate the speed of stars and galaxies.

These phenomena have been verified experimentally. As an example, Cherenkov radiation occurs when subatomic particles are released from nuclei at above the speed of light of the medium (still below the speed of light in a vacuum) and must decelerate. The energy loss of the deceleration is in the form of light.

Also, there are radioactive particles created in the upper atmosphere by cosmic radiation that have very short half-lives but still reach the surface of the Earth before they decay because of time dilation. Mass increases had been measured for particles in accelerators travelling close to the speed of light.

Einstein described *time-cones* to treat the issue of what can be known in the universe and what can influence other events in the universe. We can only influence those events that are within our own space-time coordinates. For example, we could send a signal at the speed of light, 186,000 miles per second, to affect some process. If we wanted to affect an event that will happen one week from now, we must send a message some time before the event. Light travels 1.1×10^{11} miles in a week. Therefore, we could not affect an event that will happen one week from now at any point beyond that distance. (The Milky Way galaxy is about 6×10^{17} miles across. That means, if we are at one end of the galaxy, we can only affect events at the other end that will happen about 100 thousand years from now!) (See Link 12.18.)

Link 12.18 Time Cones

<http://bit.ly/1f0WqdG>

12.7 Quantum Mechanics

In 1859, A German chemist, **Robert Bunsen** (1811–1899), and a German physicist **Gustav Kirchhoff** (1824–1887), invented the spectroscope by mounting a prism on a telescope. It had been known for some time that different elements emitted different colors of light when placed in a flame. The spectroscope dispersed the light by wavelength and made it possible to determine the *spectra* of various elements.

Surprisingly, the spectra of elements were discontinuous, that is, only certain wavelengths were emitted. (See Link 12.19a & b.)

Link 12.19a Spectroscope

<http://bit.ly/13PWBUi>

Link 12.19b Atomic Spectra

<http://bit.ly/16J9Cop>

Around 1868–1870, J.N. Lockyer discovered new spectroscopic lines in sun. He surmised this was an element not yet discovered on Earth. In 1895, William Ramsey confirmed Lockyer's results and helium (named for the sun, *Helios* in Greek) was discovered. In 1905, Helium was discovered in pockets within the Earth by companies drilling for natural gas. (However, helium does not form compounds with other elements and the helium atom is so light that it quickly floats to the top of the atmosphere. Thus, when helium is released on the surface of Earth, it quickly disappears.)

The results of spectral measurements showed that atomic transitions occur in quantum steps not continuously. Because spectral lines are at discrete energies, it means that only those energy transitions are possible. This is saying something fundamental about the nature of atomic structure.

As you recall, Thomson identified electrons as very light, negative particles that were easily removed from the atom and Rutherford showed the positive charge and most of the mass was located in a nucleus. This raises two important scientific questions: 1) what holds this nucleus together? (The discovery of the neutron was the first step in understanding nuclear physics.)

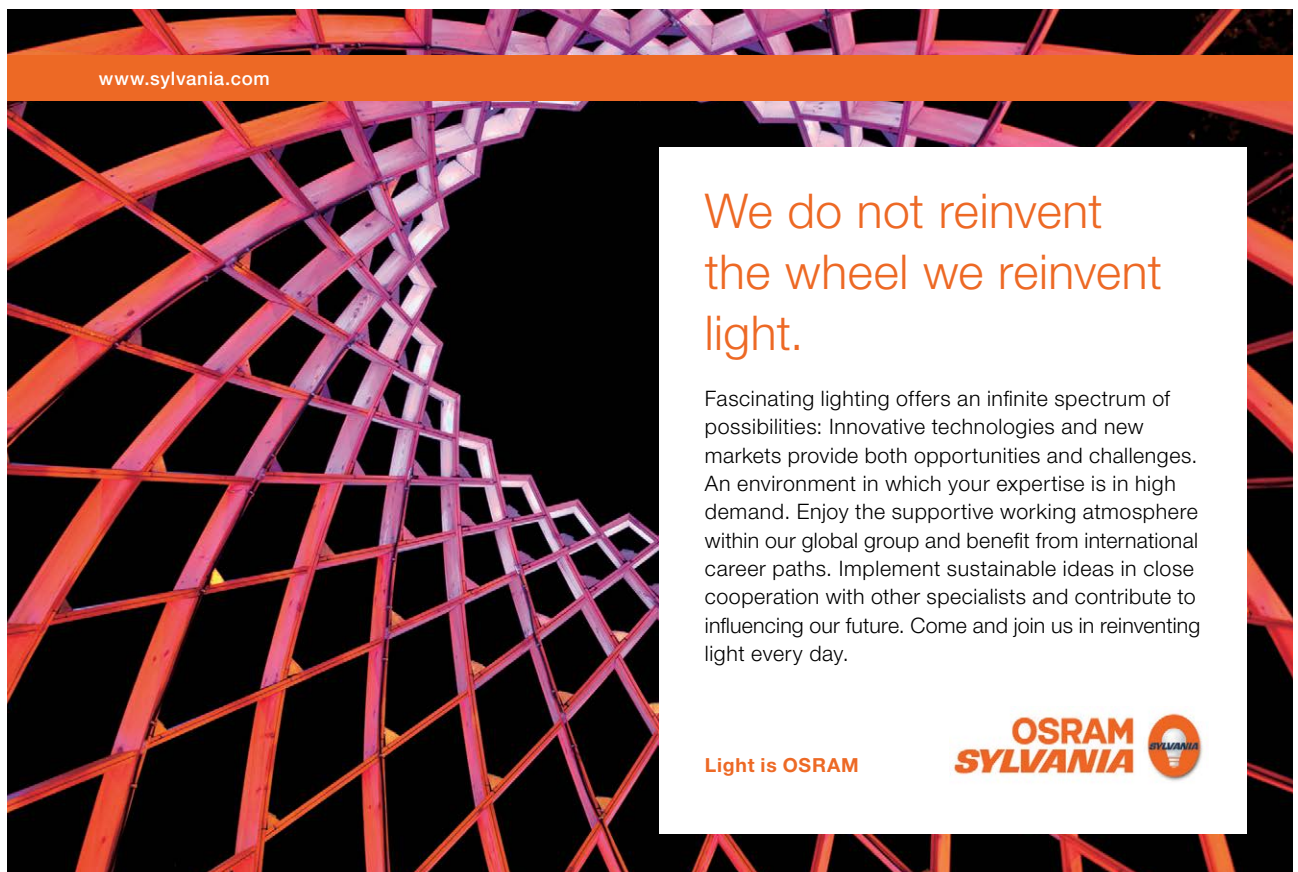

www.sylvania.com

We do not reinvent
the wheel we reinvent
light.

Fascinating lighting offers an infinite spectrum of possibilities: Innovative technologies and new markets provide both opportunities and challenges. An environment in which your expertise is in high demand. Enjoy the supportive working atmosphere within our global group and benefit from international career paths. Implement sustainable ideas in close cooperation with other specialists and contribute to influencing our future. Come and join us in reinventing light every day.

Light is OSRAM

OSRAM
SYLVANIA



2) With a massive, positive nucleus surrounded by removable electrons, it was logical to propose that Newtonian mechanics, using Coulomb's law instead of the law of gravitation, would explain atomic physics. But, the solution to this problem implies that the electron will simply spiral to the nucleus, losing all its energy. It was observed, however, now that Einstein had showed the energy of light was a function of its frequency, or wavelength, and behaved as photons, that electrons *jumped* from one energy level to another either absorbing or emitting a specific energy of light. A new mechanics was needed to solve the atom. And, since that mechanics is based upon the light quantum, it acquired the name of quantum mechanics. The second question finds its solution in the replacement of Newtonian Mechanics with Quantum Mechanics.

Niels Bohr (1887–1951) was a young Danish physicist working with Rutherford in 1912. Deciding that electrons could only exist in particular orbits around nuclei, Bohr, who had followed the arguments of Planck and Einstein, proposed an atomic model that would have the angular momentum of the electron mvr equal to $nh/2\pi$, where $n = 1, 2, 3, \dots$ ($h/2\pi$ is the orbital form of Planck's constant.) If this quantum number, n , must be an integer, then the energy transitions would be discrete as experimentation showed. Bohr's equation correctly calculated the spectra given off by various elements.

Bohr's equation also agreed with Einstein's photoelectric effect which had showed that the energy of light was $h\nu$ where ν is the frequency. (Additional quantum numbers were added to explain electron behavior, and to account for relativistic effects and magnetism, until it was found that four quantum numbers were sufficient to completely describe an electron.) However, Bohr gave no explanation for this behavior of electrons, only a set of equations that worked. (Correspondingly Newton gave only an equation for gravity, not an explanation.) (See Link 12.20.)

Link 12.20 Bohr Atom

<http://bit.ly/12nukGY>

Then, in 1924, a French physics student, **Louis de Broglie** (1892–1987) in his doctoral dissertation, showed from relativistic theory that the momentum of a photon could be calculated from h/λ where λ is the wavelength. The de Broglie equation is $p = h/\lambda$ (p is momentum). This equation would apply to all particles including electrons! If de Broglie was correct, not only did light (supposedly waves) have particle properties, but electrons (supposedly particles) would have wave properties! And, according to de Broglie, the length of the orbit for an electron would have to be just such that it allowed a whole number of waves to fit! This condition meant that $n\lambda = 2\pi r$. Here was a basis for Bohr's quantum number!

For two years no one could prove or disprove de Broglie's hypothesis. Then, in 1927, Davisson and Germer, at Bell Laboratories, diffracted electrons, proving their wave behavior. Again, theory had succeeded in predicting the results of experiments before they were performed. (See Link 12.21.)

Link 12.21 Electron Diffraction

<http://media-2.web.britannica.com/eb-media/28/96828-004-644E46F6.jpg>

The stage was now set for the development of the modern theory of matter. **Erwin Schrödinger** (1887–1961) an Austrian mathematical physicist, published a general theory for the propagation of matter waves in three dimensions in 1926. (One dimension is easy. Consider a violin string that will only vibrate at one of the discrete frequencies that allows exact numbers of waves to travel the length of the string.) (See Link 12.22).

Link 12.22 Violin String

<http://bit.ly/14AdJNF>

A violin string can only vibrate at certain wavelengths. If the wavelength is not a fraction ($1, 1/2, 1/3, 1/4, \dots$) of the length, then when the wave hit one end and reflected, it would cancel itself. (Remember a wave is moving up and down.) The same effect works for sound waves moving down a tube and reflecting off the bottom. There is a natural wavelength (frequency) for any tube. Try blowing across the neck of a soft-drink bottle and listening to the sound. Now, add some water to the bottle and do it again. The sound will be higher because the fundamental wavelength is now shorter.

Waves are controlled by boundaries, such as the ends of the violin string. Given a potential well – field of positive potential such as the nucleus – there exist only certain solutions to the wave equations for electrons which, in the derivation thereof, produces exactly those quantum numbers postulated by Bohr and others.

P.A.M. Dirac (1902–1984), an English mathematical physicist, derived a relativistic quantum mechanics, that not only included all of Bohr's postulated quantum numbers, but predicted there could be positive electrons. The *positron* (positive electron) was discovered shortly thereafter in certain radioactive decay processes. This was the first example of anti-matter. (When a positron encounters and electron, both are annihilated and converted to pure energy. This is another application of Einstein's most famous equation. The mass of an electron is equivalent to 0.51 MeV (million electron volts) of energy. When a positron-electron pair annihilate, two 0.51 MeV gamma rays are produced.)

Waves, however, can only be described by probabilities. And, in the modern atomic picture, we talk only of the probability of the location of an electron. In 1927, along with the startling experimental proof of electron diffraction, **Werner Heisenberg** (1901–1976) in Germany completed the destruction of Laplace's *mechanical universe* by postulating the uncertainty principle. The uncertainty principle, which has also been demonstrated experimentally, states that the uncertainties in the position (ΔX) and momentum (ΔP) of a particle must always be equal to or greater than $h/2\pi$.

$$\Delta X \Delta P \geq h/2\pi.$$

The uncertainty principle may be interpreted simply as saying that if we try to measure the position of a particle closer than a certain amount, we will affect its momentum and vice versa. However, a philosophical interpretation is that position and momentum simply don't exist below a specified level! (The uncertainty principle may be derived mathematically by applying Schwartz's Inequality Theorem to wave mechanics.)



Discover the truth at www.deloitte.ca/careers

Deloitte.

© Deloitte & Touche LLP and affiliated entities.



Click on the ad to read more

The uncertainty principle, more than any other development in science, implies that even if the total and exact history of the universe is known, its future cannot be completely predicted. (This, of course, must be comforting to those postulating the religious theory of free will.) At the beginning of the 19th century, Laplace, the great French mathematician, had stated the Newtonian idea as a complete description of the universe. According to Laplace, if the positions and velocities of all the particles in the universe were known at one time, and if all the various force laws were known, then the positions and velocities of all these particles could be calculated and predicted for any future time.

Heisenberg says *No!* Only the probabilities can be known. It is this difference in view that is referred to in the famous Einstein quote: “God does not play dice with the universe.” Einstein was never comfortable with quantum mechanics. On the other hand, Stephen Hawking, one of the greatest physicists of our time, says: “...God not only plays dice, but also sometimes throws them where they cannot be seen!”⁵³

By 1932 the electron was completely described by quantum mechanics. And today, we know of four forces, two of which pertain only to the nucleus. These forces are: Gravity, Electromagnetic Force, The Strong Nuclear Force, and the Weak Nuclear Force. All but gravity have been successfully described using quantum mechanics. Developing a successful quantum-gravity theory remains one of the great scientific challenges of our time.

13 Science and the U.S. Government (1900–)

13.1 The Atomic Bomb

To pay WW I debts, governments, including France and Germany, simply printed more money creating run-away inflation. Americans held most of the world's debt.

In 1923, the German mark became practically worthless. It literally took a suitcase full of money to buy a loaf of bread and a pound of ham. People went to the market with wheelbarrows of money. The value of the mark fell hour by hour, and when workers were paid they would rush out to buy food or whatever, before their pay became worthless. Eventually, the German economy was reduced to barter and payment in kind. By November 1923, the government issued new marks at the ratio of *one trillion to one*.

In 1925, **J. Robert Oppenheimer** (1904–1967) graduated *summa cum laude* from Harvard University and set sail for the Old World. First Oppenheimer stopped at the University of Cambridge to work at the Cavendish Laboratory under the direction of now *Lord Rutherford*. At Cambridge, Oppenheimer was immersed in the new atomic science.

Max Born invited Oppenheimer to come to Gottingen University, then one of the leading German Universities in mathematics and physics. No atmosphere could have been more stimulating or exciting for the young New York City physicist. Paying regular visits to Gottingen at this time were Niels Bohr from Denmark, and Paul Dirac, an English physicist on his way to becoming one of the great scientific names of the 20th century. **Enrico Fermi** (1901–1954) studied there just before Oppenheimer arrived. They discussed and debated the new theories of E. Schrodinger and Werner Heisenberg, with tutoring from the great Dane, Niels Bohr himself. After taking his doctorate from Gottingen in May 1927, Oppenheimer spent time studying at the universities of Zurich and Leyden. At Leyden in Holland, he astonished professors and students alike by giving a lecture in Dutch only six weeks after his arrival.

Nuclear science prospered. In 1932, Chadwick had discovered the neutron and explained why the different isotopes of an element had different atomic weights. (Marie Curie's daughter, Irene Joliot-Curie and her husband Frederick had actually done the definitive experiment earlier but misinterpreted the results. Chadwick won the Nobel Prize in 1935 that could have been won by the Joliot-Curies. (The Joliot-Curies went on to win the Nobel Prize for the discovery of artificial radioactivity.)

The heaviest naturally occurring element, uranium, (92 protons and 92 electrons) has three naturally occurring isotopes:

- ^{234}U with 142 neutrons, only a trace in natural uranium
- ^{235}U with 143 neutrons, 0.7% abundant
- ^{238}U with 146 neutrons, more than 99% abundant

In 1934, Fermi decided to bombard systematically the known elements with neutrons, hoping in the process to create artificially radioactive isotopes. Fermi began with light elements (water) bombarding hydrogen and oxygen simultaneously, and worked his way through the periodic table bombarding sixty-three stable isotopes, and discovering thirty-seven artificially radioactive isotopes. (Fermi won the 1938 Nobel Prize in Physics for this work.)

Fermi also discovered that hydrogen and carbon were useful in slowing down neutrons and slow moving neutrons were more likely to be captured by a nucleus than fast moving neutrons. When Fermi's team bombarded uranium, there was no clear result, and Fermi was uncertain what had happened. Initially, Fermi thought that uranium had captured the neutron transmuting it element 93 or perhaps even 94. Fermi wasn't certain what had been accomplished. (Fermi may have actually achieved nuclear fission without knowing it.)

But the Great Depression, which assisted Hitler's rise to power, was to change the peaceful pursuit of nuclear science. In 1938, Germans **Otto Hahn** (1879–1968) and **Fritz Strassman** (1902–1980) following up on Fermi's experiment, likewise bombarded uranium, discovering that uranium nuclei broke into two roughly equal pieces. They identified radioactive barium isotopes (atomic number 56), fragments of uranium itself. Hahn and Strassman were working in Lise Meitner's laboratory. Meitner had been dismissed because she was Jewish. But Meitner helped them interpret their results and all realized that Hahn and Strassman had discovered nuclear fission of uranium by repeating Enrico Fermi's experiment! They also noted the mass of the fragments was less than the mass of uranium which meant, of course, that mass had been converted into energy during the fission process. Hahn informed Lise Meitner who had fled to Sweden and, in turn, informed Niels Bohr. (See Link 13.1.)

Link 13.1 Nuclear Fission

<http://bit.ly/157x0cO>

A neutron is captured by a ^{235}U nucleus and the nucleus breaks into smaller nuclei releasing additional neutrons and energy. Hahn and Strassman found the smaller nuclei after the reaction and, adding up all the mass produced, determined that it was less than the starting mass thereby concluding that energy had been produced. ($E = mc^2$) A chain reaction would occur if the neutrons released would also cause fissions. A critical mass would be that amount of fissionable material, arranged in such geometry that each fission would produce another fission.

Bohr carried the news to America in January, 1939, and physicists in the U.S. knew immediately that an atomic bomb was theoretically possible. Given that the Germans had achieved nuclear fission first, the physicists in America were very apprehensive. Immigrant physicists, especially Hungarians Leo Szilard and Edward Teller, German Albert Einstein, and others, had no doubt that Hitler and the Germans would push forward to develop atomic weapons. As they had all been students in Germany, they were in awe of Germany's reputation for physics and chemistry – the world's leader. Hitler controlled the world's top scientists, except for those who had already escaped from Europe. (In 1933, Jewish professors were forced from their positions and 11 Nobel Laureates in Physics, 4 in chemistry, and 5 in medicine left Germany as a result.)

In August 1939, under the encouragement of Szilard, Einstein wrote to President Roosevelt, alerting the President to the importance of the Hahn-Strassman achievement, and warning the President that the Germans might develop a powerful bomb. In September 1939, Hitler invaded Poland touching off the beginning of World War II. By October, Roosevelt discussed Einstein's letter with his advisors, and authorized preliminary uranium studies to be carried out. By November 1939, the United States has a small, official uranium project, and the Americans and British decided to ban publishing atomic energy information in professional journals. When the publications stopped, the Russians surmised that Americans were exploring the possibility of an atomic bomb project.

In December, 1940, **Glenn Seaborg** (1912–1999) isolated Plutonium at the cyclotron at the University of California at Berkeley. Plutonium, element number 94, is two elements beyond uranium in the periodic table. Plutonium turned out to be fissionable and a better weapons material than uranium.

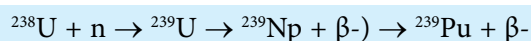

On October 9, 1941, after being briefed on the uranium project, Roosevelt asked if a bomb could be built, and how much it would cost. A decision was being made to launch the atomic bomb project, even before the Japanese attack on Pearl Harbor on December 7, 1941. It was not until August 1942, however, that the Army established the Manhattan Engineer District of the Army Corps of Engineers under the leadership of General Leslie Groves, the man who built the Pentagon. The atomic bomb project was code-named the *Manhattan Project*.

Some scholars have characterized the Manhattan Project as the biggest secret of the war – certainly it was big and security was tight and compartmentalized. Even Congress did not know the details of the \$20 billion project. Then a US Senator, Harry Truman started to investigate the expenditures, but was halted. Even though he was elected Vice President in 1944, Truman was never briefed about the Project until Roosevelt died and Truman was sworn in as President on April 12, 1945.

The Manhattan Project established secret cities: Oak Ridge in Tennessee, Hanford in Washington state, and Los Alamos in New Mexico. Compartmentalization and *need-to-know* were established as security principles. There is no evidence that the Germans knew about the Manhattan Project, but Russian atomic espionage was excellent, even to the extent that a Russian agent penetrated Los Alamos in the person of Klaus Fuchs.

While there was important science in the Manhattan Project, the task of building an atomic bomb was essentially a gigantic engineering problem. In an atomic bomb, energy is produced by the fission of atoms with mass being converted to energy. Contrary to what Fermi initially believed, it turns out that it is ^{235}U (0.7% abundant) that fissions with slow neutrons rather than the much more abundant ^{238}U .

SIMPLY CLEVER

ŠKODA



We will turn your CV into
an opportunity of a lifetime

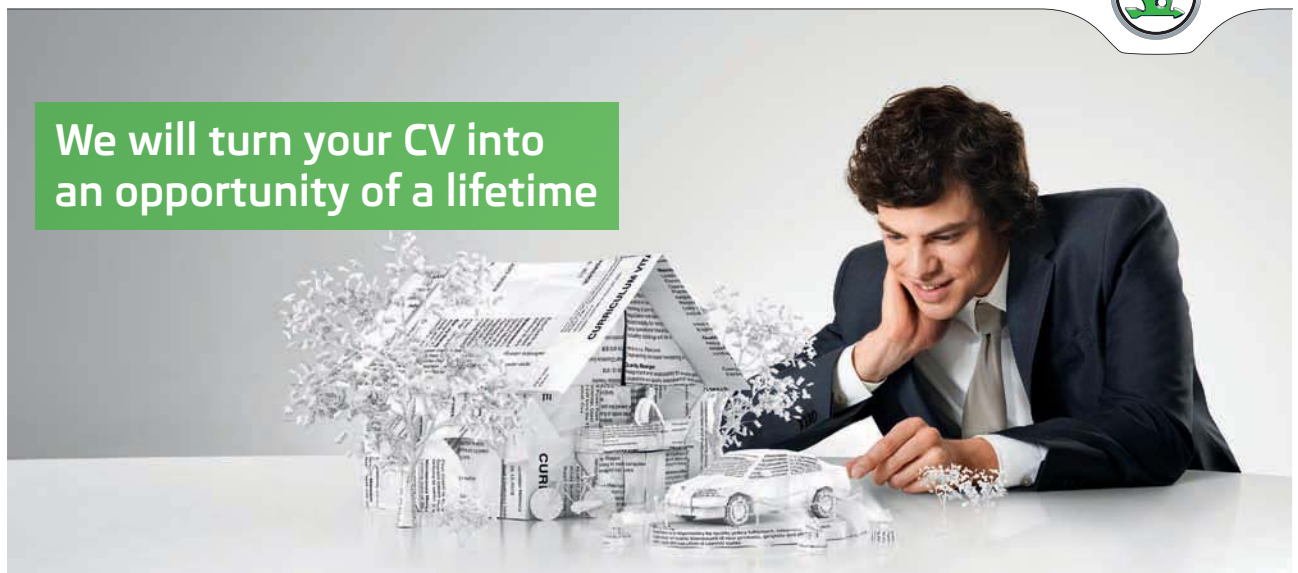

Do you like cars? Would you like to be a part of a successful brand?
We will appreciate and reward both your enthusiasm and talent.
Send us your CV. You will be surprised where it can take you.

Send us your CV on
www.employerforlife.com



Click on the ad to read more

The first problem to be solved was obtaining sufficient amounts of ^{235}U to make a bomb. (How can you separate ^{235}U from ^{238}U when ^{238}U and ^{235}U are almost identical chemically?) The second problem was to control the chain reaction. A slow reaction would be required for nuclear reactors and a very rapid one for nuclear bombs.

The only techniques for isotope separation were physical, not chemical, but the masses of ^{238}U and ^{235}U differed by less than 1%. The lighter ^{235}U could be drawn off at the center of a centrifuge. A series of centrifuge in a cascade mode would slowly enrich the uranium to the fissionable isotope. But in building such a system vibration was among the biggest problems.

Pioneered by Alfred O. Nier of the University of Minnesota, and adopted by Ernest Lawrence at the University of California, they designed and built an industrial size mass spectrograph, sending a stream of charged particles through a magnetic field. The lighter isotope, U^{235} , would be deflected more by the magnetic field than the heavier U^{238} . The gigantic mass spectrograph was the project of the famous Y-12 Plant at Oak Ridge, Tennessee. There was not enough copper available to build the huge magnets required, so Groves obtained 15,000 tons of silver bullion from the U.S. Treasury silver reserve to substitute for copper. (The silver was returned to the US Treasury after the War). By mid-1944, the mass spectrometer had produced 200 grams of 12% U^{235} , nowhere near enough for weapon production. (A critical mass of ^{235}U is about 50 kg. For ^{239}Pu , it is about 10 kg and can be reduced to 5 kg using neutron reflectors.) (See Link 13.2.)

Link 13.2 Y-12 Magnetic Separation of Uranium

<http://bit.ly/150hATD>

The method that succeeded in uranium isotope separation is called gaseous diffusion. Uranium was converted to a gaseous state by the formation of uranium hexafluoride, UF_6 . The slightly lighter $^{235}\text{UF}_6$ – (about 0.85% lighter) diffused through a porous barrier slightly faster. Fortunately, 100% of fluorine occurs as ^{19}F . Otherwise, the mixture of isotopes would render the technique impractical. A huge gaseous diffusion cascade for enriching the uranium to weapons grade was built at the K-25, Oak Ridge site. The cascade was placed in a U-shaped building, 5 stories high, 1000 feet wide, and one half mile long. (See Link 13.3.)

Link 13.3 K-25 Gaseous Diffusion Plant

<http://www.smithdray1.net/k25heritage/images/K25%20in%20color2.jpg>

A major problem was that UF_6 rapidly reacts with water to make highly corrosive HF (hydrofluoric acid). UF_6 is made from fluorine, the most reactive element known. (Fluorine is extremely toxic and burns explosively with many materials. Generally, burning is considered combining with oxygen. However, fluorine releases considerably more energy than oxygen when materials are burned in it.) The major trick was to develop a barrier through which UF_6 would tend to pass, becoming slightly richer in the ^{235}U component in each step. But the barrier had to withstand the corrosive environment of UF_6 . The answer was a nickel barrier. (Barrier technology may be the last remaining *atomic secret*.) It turned out that the K-25 gaseous diffusion process and the Y-12 magnetic separation process working together produced barely enough enriched material to make one uranium bomb by 1945, the one dropped on Hiroshima.

Seaborg had discovered plutonium in December, 1940, and by the next May determined that ^{239}Pu was 1.7 times more likely to fission than ^{235}U . Plutonium is created when ^{238}U captures a neutron and loses a beta-particle from the nucleus in two successive steps transmuting first into ^{239}Np (neptunium) and then into ^{239}Pu . Plutonium can be produced in a nuclear reactor by placing a blanket of ^{238}U around the reactor core. The question was could one build and operate a self-sustaining, controlled nuclear reactor? (See Link 13.4.)

Link 13.4 Plutonium Production

http://www.3rd1000.com/elements/plutonium/350px-Hanford_Site_1945.jpg

This is the major significance and importance of the work conducted by Enrico Fermi and his team first at Columbia University and then later at the Metallurgical Laboratory in Chicago in 1941-1942. The first critical pile was built under the stands at Stagg Field at the University of Chicago. (After receiving the 1938 Nobel Prize in Stockholm, Fermi came to the US instead of returning to Italy. Fermi's wife was Jewish and they were afraid to remain in Fascist Italy.)

For a chain reaction to occur, the neutrons released by each fission have to produce exactly one additional fission. The symbol k is used to represent the number of additional fissions caused. If k is less than 1, then the reaction will die out. If k is greater than 1, the reaction will continue to increase. Fermi knew that for a stable nuclear reaction, a configuration would have to be designed such that k was exactly 1. Elements had been found, including boron and cadmium that easily absorbed neutrons without fissioning. These elements, particularly cadmium which is a metallic element, made good control devices for Fermi's reactors. A rod of cadmium could simply be inserted into the pile to control the reaction.

Fermi conducted a number of experiments building piles of graphite (which slowed down the neutrons making them better for causing fission), uranium oxide, and metallic uranium. He obtained values of k that got closer and closer to 1. It was a cold day on December 2, 1942, when Fermi achieved the first controlled chain reaction in CP1 (critical pile number 1). This event has been called the beginning of the nuclear age because it demonstrated that humans could control or moderate nuclear processes. CP1 was a massive construction with 396 tons of graphite (to serve as the moderator), 40 tons of uranium oxide, and 6.2 tons of pure uranium metal. (See Link 13.5.)

Link 13.5 CP1 Nuclear Reactor

<http://bit.ly/1bR9p1O>

CP1 demonstrated the possibility of using nuclear reactors to generate power. It also demonstrated the possibility of plutonium production reactors to create special nuclear material. (These are now called *breeder reactors*.)



The advertisement for e-Learning for Kids features a central image of a smiling teacher leaning over a laptop to assist two young students, a boy and a girl. To the right, two smaller circular images show children engaged in learning activities: one group of girls looking at a book, and another group of children working at computers. The background is a vibrant yellow and orange swirl design. In the top left corner, the e-Learning for Kids logo is displayed, consisting of a colorful grid of squares above the text "e-learning for kids".

- The number 1 MOOC for Primary Education
- Free Digital Learning for Children 5-12
- 15 Million Children Reached

About e-Learning for Kids Established in 2004, e-Learning for Kids is a global nonprofit foundation dedicated to fun and free learning on the Internet for children ages 5 - 12 with courses in math, science, language arts, computers, health and environmental skills. Since 2005, more than 15 million children in over 190 countries have benefitted from eLessons provided by EFK! An all-volunteer staff consists of education and e-learning experts and business professionals from around the world committed to making difference. eLearning for Kids is actively seeking funding, volunteers, sponsors and courseware developers; get involved! For more information, please visit www.e-learningforkids.org.

At the Oak Ridge laboratory called X-10 (now called the Oak Ridge National Laboratory or ORNL) an experimental reactor called the X-10 Graphite Reactor was built. This second critical pile became the first reactor designed for continuous operation. With the success of CP1 and X-10 Graphite Reactor, the Manhattan project, in cooperation with the du Pont chemical company, built huge production facilities at Hanford, Washington, using the power generated from Grand Coulee dam, and the Columbia River for cooling the huge reactors. The Hanford reactors produced plutonium in the ^{238}U blanket, and then, because plutonium is chemically different from uranium, chemical separation techniques were used to extract the fissionable plutonium. This is a much easier process than the separation of the uranium isotopes. (See Figures 13.6 and 13.7.)

Link 13.6 X-10 Graphite Reactor

http://www.hcc.mnscu.edu/chem/abomb/X10_Cutaway.jpg

Link 13.7 Hanford Reactors

http://farm1.static.flickr.com/42/83332804_49aa10d9ba.jpg?v=0

The modern nuclear power station simply provides heat from a nuclear reaction instead of from burning coal or oil. The heat is used to produce steam that turns turbines that turn generators. (See Link 13.8.)

Link 13.8 Nuclear Power Plant

<http://www.atomicarchive.com/History/coldwar/images/tmi.jpg>

The next problem to be solved is how you build a bomb? How does a fire cracker work? You want to contain a heat buildup, from burning gun-powder in the fire cracker, until it has sufficient force to cause an explosion as it is released. In fact, you want to contain the buildup as long as possible in order to achieve the maximum *pop*. The same is true, in general, for an atomic bomb – you want to maintain the critical mass as long as possible, to assure as many heat-generating nuclear reactions as possible, before the bomb blows itself apart. But this is a reaction time that takes place in milliseconds. Once the critical mass expands (because of heat), it quickly loses its criticality. The trick is to assemble the critical mass as quickly as possible, and hold it together as long as possible. (See Link 13.9.)

Link 13.9 Subcritical Masses Brought Together

<http://bit.ly/1bR9rH5>

In order to create a nuclear explosion, two or more sub-critical masses must be brought together very rapidly creating a super-critical mass. The rapid increase in fission rate by the super-critical mass then causes a very rapid temperature increase and an explosion.

In the Manhattan project there were two solutions proposed for triggering a nuclear explosive and both were successfully implemented. The first was the *Gun-style bomb*. A sub-critical *ball* or mass of fissionable material was placed on the end of an artillery shell. (Uranium, which is heavier than lead, makes a fine bullet.) The uranium ball is fired into a *catcher's mitt* of fissionable material at the end of the gun barrel. High explosives were used to fire the gun-style bomb. Technically, the concept is straight-forward, but the engineering requirements are very difficult. It takes 52 kg of ^{235}U to make a critical mass. It only takes 10 kg of ^{239}Pu . With neutron reflectors, to return neutrons to the fissionable material instead of letting them escape, the amount of ^{239}Pu can be reduced to 5 kg. *Little Boy*, the Hiroshima Bomb, was a ^{235}U gun-style bomb. (See Link 13.10.)

Link 13.10 Gun-Style Bomb (Little Boy)

<http://www.historylink101.com/ww2photo/atomic-bomb-little-boy.jpg>

There was great disappointment when it was discovered that you could not build a plutonium gun-style bomb. The neutron activity of plutonium would cause any gun-style bomb to pre-detonate, thereby causing a fizzle rather than an explosion.

Seth Nedermeyer, a young physicist at Los Alamos, came up with the ingenious idea of an *implosion bomb*. The implosion bomb uses several sub-critical pieces of fissionable material and blows them together simultaneously using dynamite. An implosion bomb was successfully tested at Trinity site on July 16, 1945. President Truman learned of this at Potsdam, where he was consulting with Joseph Stalin and Winston Churchill about the post-war world. *Fat Man*, the bomb dropped on Nagasaki, was an implosion bomb using plutonium. (See Link 13.11.)

Link 13.11 Implosion Bomb (Fat Man)

<http://www.historylink101.com/ww2photo/atomic-bomb-fat-boy.jpg>

In summary, at Hiroshima on August 6, 1945, *Little Boy* (Gun-Style) with a yield the equivalent of 20 kilotons of TNT, killed 70,000 immediately, and eventually 200,000; and at Nagasaki on August 9, 1945, *Fat Man* (Implosion-style), with a yield of 21 kilotons, killed 40,000 immediately, and eventually 140,000. An interesting historical point is that General Dwight D. Eisenhower, the Supreme Allied Commander and future Presidential successor to Truman, opposed the use of the atomic bomb in Japan. He did not think it was necessary. (See Link 13.12.)

Link 13.12 Atomic Bomb Explosion

<http://i285.photobucket.com/albums/ll62/Findalis/atomic-bomb.jpg>

The United States emerged from World War II not only militarily and economically the most powerful nation on Earth, but also the richest nation scientifically and technically. Before the war, the best American students went to England and Europe to study for the doctorates. After the war, American universities and research laboratories were second to none in the world. The center for basic science research in numerous fields, including nuclear physics, chemistry, biology and medicine, had shifted to the New World.

Before World War II, the United States had a benign and largely laissez-faire attitude toward science research and development. After the war, the government was not only deeply involved in science, but in the important area of atomic energy research and development the United States government enjoyed a virtual monopoly.

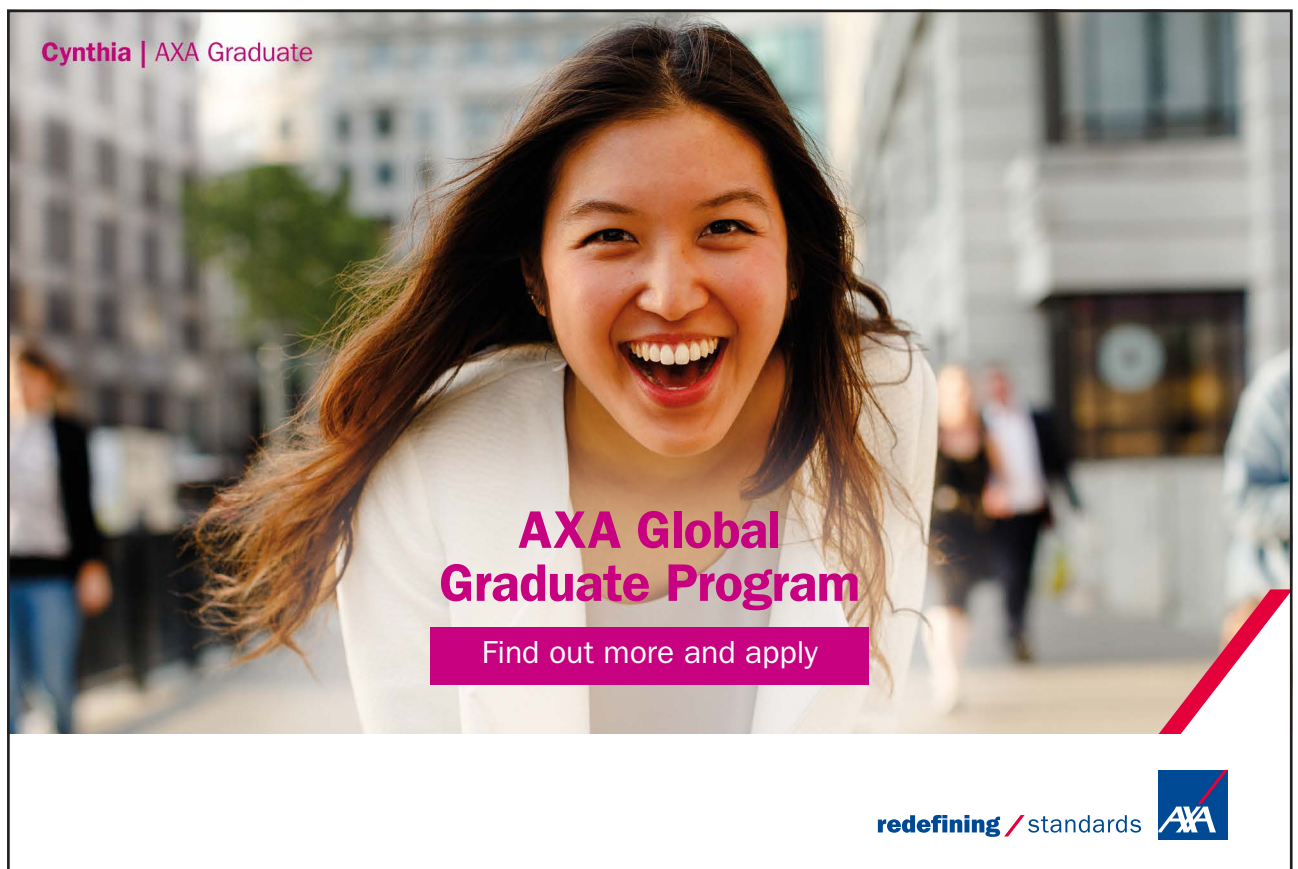

Cynthia | AXA Graduate

AXA Global Graduate Program

Find out more and apply

redefining / standards AXA

During the war, the Manhattan Engineering District had established several large, secret scientific laboratories whose principal task was developing the atomic bomb. These included: the Metallurgical laboratory (Met Lab) at Argonne Illinois managed by the University of Chicago; Berkeley Laboratory run by Ernest Lawrence at the University of California; the Los Alamos Laboratory directed by J. Robert Oppenheimer in New Mexico; and the Clinton Laboratory established at Oak Ridge, Tennessee. While each of these laboratories supported the atomic bomb project, they also conducted basic research related to nuclear science and technology, including physics and chemistry, materials science and engineering, and biology and medicine.

It seemed evident in 1946 that the United States simply could not walk away from the atomic bomb. As Oppenheimer once stated, the atomic genie was out of the bottle. The Atomic Energy Act of 1946 established the Atomic Energy Commission to assure civilian control of atomic energy policy and facilities. The most extraordinary aspect of the Atomic Energy Act was that it identified atomic energy information as *Restricted Data*. There were Top Secret, Secret, and Confidential categories and atomic energy information was *born classified*.

The Atomic Energy Commission (AEC), which was also exempt from Civil Service rules and ordinary government procurement regulations, obtained unusual independence and power. The AEC, of course, was responsible for the development of the United States nuclear weapons program. In addition, for more than a decade after World War II, the AEC was the major source of government funding for science research and development. All other government agencies combined did not equal the AEC's science budget during these years.

To support its research and development mission, the AEC established a system of national laboratories, most of them facilities inherited from the Manhattan Project. In addition to nuclear weapons, the AEC conducted research on nuclear power reactors, basic physical sciences including chemistry and physics, high energy physics, superconductivity, computer sciences, biology and medicine, and eventually energy and environmental related sciences.

By 1957, the AEC allocated \$60 million for research, 70% going to National Laboratories and 30% directly to 118 universities and other private laboratories. The dream of a separate federal science agency became a reality in 1950 when the National Science Foundation (NSF) was established. After years of lobbying, Vannevar Bush and supporters, in 1947, convinced Congress to create the NSF science agency along the lines favored by the academic scientists. President Truman vetoed the bill. Truman declared that he would only sign an NSF bill which authorized appointment of the director by the President with a Presidential appointed board acting in an advisory and policy-making capacity.

In 1950 the impasse was resolved in the President's favor and NSF became the principal direct funding agent for the nation's scientists. In the first two years NSF only received enough money to organize itself. FY 1952, the NSF received only \$3.5 million (about 6% of the AEC budget for basic research).

13.2 Sputnik and the Space Race

The most startling and exciting development of the 1950s outside the nuclear field was the astounding progress in perfecting missile propulsion systems. Like the Russians, the American missile program was organized around a core of German rocket scientists who left Germany after the war. Werner von Braun, one of Hitler's chief rocket experts, became the head of the American program.

The United States built a huge nuclear weapons deterrent including the Strategic Air Command bomber fleet with its thermonuclear warheads; ICBM's (intercontinental ballistic missiles); and the Polaris missile armed nuclear navy centered on nuclear submarines. Russia, based partly on US secrets obtained through espionage, also built larger and larger atomic weapons in this *nuclear arms race*.

Then on October 4, 1957, America woke up to the *beep-beep-beep* of *Sputnik I* orbiting the heavens overhead. One can scarcely overstate the shock of American politicians, scientists, and citizens to this accomplishment of the Soviet Union. More than anything else, Sputnik encouraged the Congress to open government purse strings to finance expanded programs in science research and education. (See Link 13.13.)

Link 13.13 Orbiting Russian Satellite

<http://static.guim.co.uk/sys-images/Guardian/Pix/pictures/2008/04/16/sputnikmain2.jpg>

Sputnik, of course, posed a serious military threat to the United States. Despite the fact that the Soviets had nuclear weapons by 1956, they had no credible delivery system. For Soviet bombers, both Bears and Bisons, without advanced bases, the flight from the Soviet heartland over the poles and across Canada to the United States was just too long to be a serious threat. But the possibility of Soviet intercontinental ballistic missiles changed all that, and Sputnik made it perfectly clear that the Russians had that capability much sooner than American planners had estimated.

Perhaps more importantly, Sputnik prompted an agonizing national self-appraisal that questioned American education, scientific, technical, and industrial growth. Under intense pressure from Congress and the media, the United States tried to get something (almost anything) into space. The first American rockets teetered and then exploded on the launching pad. *Kaputnik*, *flopnik*, *stay-put-nik*, brayed the news media. Finally, on January 31, 1958 Werner von Braun's team lifted America's first artificial satellite, Explorer I, into space on the shoulders of an Atlas military rocket.

By putting a man into orbit, the Russians once again beat the United States. On April 12, 1961, Cosmonaut Yuri Gagarin flew on orbit around the Earth in Vostok I. A month later, Alan B. Shepard, Jr. was the first American in space with a fifteen minute sub-orbital flight. In August 1961, no American had yet orbited the Earth when Russian Gherman Titov flew 17 orbits. (See Link 13.14.)

Link 13.14 Orbiting Capsule

<http://www.flightglobal.com/blogs/hyperbola/ESA%20ARD%20capsuleW445.jpg>

As an immediate response to the Sputnik crisis, President Eisenhower established the President's Science Advisory Committee. Congress responded to the *Sputnik Crisis* with two pieces of landmark legislation: in July 1958, the National Aeronautics and Space Administration (NASA) was created; and, in 1958, The National Defense Education Act (NDEA) was passed and played a substantial role in funding both graduate education and research in science and engineering.

After John F. Kennedy became President, the Democrats virtually adopted NASA as their science agency. (The AEC was still dominated by entrenched Republicans.) Kennedy promised *to get America moving again*, among other ways by sending an American to the Moon. In May 1961, Kennedy pledged that an American would land on the Moon before the decade was out. (The goal was achieved by Neil Armstrong in July, 1969). Soon NASA rivaled the AEC as a source of funding for basic research. (See Link 13.15.)

I joined MITAS because
I wanted **real responsibility**

The Graduate Programme
for Engineers and Geoscientists
www.discovermitas.com





Month 16
I was a construction
supervisor in
the North Sea
advising and
helping foremen
solve problems

Real work
International opportunities
Three work placements





Link 13.15 U.S. Moon Landing

http://mechanicsnationalbank.com/images/timeline/History_Moon_Landing_Armstrong.jpg

But the best news from the perspective of the academic science community was the spectacular growth of the NSF during the period the United States was racing for the Moon. For FY1958 (the budget before Sputnik), the NSF budget had been \$40m, still not exceeding the AEC's budget for basic research. For FY 1959, Congress appropriated \$134m, more than tripling the money. By 1968 (at the end of the Kennedy/Johnson administration), the NSF budget stood at \$500m. It continued to grow in the Nixon administration, and by 1972 stood at \$650m. The NSF FY2006 budget was \$5.9 billion. The FY12 budget request was \$7.7 billion.

The modern research university depends upon government funding from NSF; NIH (the National Institutes of Health); NASA; EPA (Environmental Protection Agency); DOE (Department of Energy); DOD (Department of Defense); ARO (Army Research Office); ONR (Office of Naval Research); AFOSR (Air Force Office of Scientific Research); and others, including the National Laboratory System.

The federal granting agencies have fostered government-university-industrial partnerships. In most first-world countries, there are 5–10 strong universities. In the U.S., you can obtain a PhD in science in more than 200 universities.

14 A New Understanding of Life (1700–)

14.1 The Cell

What we know as *Biology* (life study) today was known as *Natural Philosophy* until well into the 18th century. Scholars of Natural Philosophy concentrated on exploration, discovery, and taxonomy, i.e. on the classification of the species. Because of Buffon, more than any other, the term *Natural History* replaced Natural Philosophy and then, in the 19th century, the modern term *Biology* took the place of both. In the 19th Century, Darwinism focused on variation, struggle for existence, and natural selection, i.e., the evolution of the species.

Like pre-modern physics and chemistry, progress in Natural Philosophy was limited to that which could be seen by the eye and manipulated by the hand. Key to the emergence of modern *Biology* in the 19th century was the development and refinement of the light microscope.

The microscope dated from about 1590 when the Dutch developed a crude compound microscope by combining a concave and convex lens at the end of a tube. (See Link 14.1.)

Link 14.1 Dutch Microscope

<http://www.molecularexpressions.com/primer/museum/images/dutchsidepillar1700s.jpg>

Antony van Leeuwenhoek (1632–1723) improved the microscope and undertook some remarkable studies of crystals, minerals, plants, animals, water, saliva, seminal fluid, and even gun powder. He discovered sperm and various other microorganisms. Others thought the presence of these animalcules, as he called sperm, were a sign of disease because they were also found in the semen of persons suffering from gonorrhoea. At the time of Leeuwenhoek's death, relatives found more than 400 microscopes and magnifying glasses in his laboratory.

Leeuwenhoek's discoveries were simply before their time. Unlike the telescope, which was invented at about the same time and thrust astronomy forward, the microscope was considered more of a toy than a tool in its early days.

As we pointed out earlier, Malpighi discovered the capillaries using a microscope in 1661. Malpighi's discovery gave important support to the theory of blood circulation. He and **Robert Hooke** (1635–1702) advanced the application of microscopy. Hooke examined cork and found little pores which he called cells. He also observed cells in green plants. Hooke published *Micrographia* in 1665, a wonderfully illustrated book on his microscopic studies. Another scientist, Nehemiah Grew published several volumes on the *Anatomy of Plants* (1682) exploring various parts of plants with the microscope. He thoroughly described the reproductive organs of plants, and came close to understanding their function. (See Link 14.2.)

Link 14.2 Hooke's Cells

http://upload.wikimedia.org/wikipedia/commons/1/17/Cork_Micrographia_Hooke.png

But the work of all these scientists was limited by serious problems of the 17th and 18th century microscopes. Poor quality glass, sometimes cloudy or with bubbles and distortions, could be troublesome. More seriously, lens grinders had problems with chromatic and spherical aberrations in the lens. (Chromatic aberrations are caused by the lens acting as a prism to produce color fringes). To increase magnification, grinders fashioned more convex lenses. But as the lens were made more and more convex, they became more prism-like, which meant that the light became separated into a rainbow of colors.

ie business school

93%
OF MIM STUDENTS ARE
WORKING IN THEIR SECTOR 3 MONTHS
FOLLOWING GRADUATION

MASTER IN MANAGEMENT

- STUDY IN THE CENTER OF MADRID AND TAKE ADVANTAGE OF THE UNIQUE OPPORTUNITIES THAT THE CAPITAL OF SPAIN OFFERS
- PROPEL YOUR EDUCATION BY EARNING A DOUBLE DEGREE THAT BEST SUITS YOUR PROFESSIONAL GOALS
- STUDY A SEMESTER ABROAD AND BECOME A GLOBAL CITIZEN WITH THE BEYOND BORDERS EXPERIENCE

Length: 10 MONTHS
Av. Experience: 1 YEAR
Language: ENGLISH / SPANISH
Format: FULL-TIME
Intakes: SEPT / FEB

5 SPECIALIZATIONS
PERSONALIZE YOUR PROGRAM

#10 WORLDWIDE
MASTER IN MANAGEMENT
FINANCIAL TIMES

55 NATIONALITIES
IN CLASS

www.ie.edu/master-management | mim.admissions@ie.edu | [f](#) [t](#) [in](#) Follow us on IE MIM Experience

Others, however, realized that there was one of two ways to develop an achromatic lens, either change the light or change the lens. One might use monochromatic light, but better yet one could construct doublet or triplet lenses with different indices of refraction. In the late 18th century John Dollond built such a lens that earned him election to the Royal Society and appointment as the optician to the King. By the 1830s, improved compound lenses literally opened up a new world for research.

At the same time, in France and America, scientists were experimenting with *Immersion Microscopy*, in which the front element of the microscope's objective lens was immersed in clear oil in which the object of the study was mounted. The correct oil would keep the light rays in the same plane as the glass, thus reducing the chromatic effect.

As you no doubt realize, there are limits to ordinary *light microscopy*. By the 20th century, *Phase-Contrast Microscopy* developed by Fritz Zernike, and the *electron microscope*, which is perhaps 20 times as sensitive as the light microscope, marvelously advanced biological research. Following is a comparison of the human eye, the light microscope, and the electron microscope. The unit used is the Angstrom (Å) which is 10^{-10} meter. Atomic bonds (bonds between two atoms) are on the order of an Angstrom. The Angstrom is now considered an obsolete unit but is still useful for this kind of comparison. (See Table 14.1 and Link 14.3.)

Instrument	Resolution (Inches)	Resolution (Angstroms)
Human Eye	1/250	1×10^6
Light Microscope	1/250,000	2×10^3
Electron Microscope		1×10^2
Tunneling Micro.		1

Table 14.1 Comparison of Vision Instruments

Link 14.3 Tunneling Electron Microscope

<http://www.crystal.ee.uec.ac.jp/image/pl2.jpg>

Matthias Jacob Schleiden (1804–1881) was a mental and emotional cripple. He was born in Hamburg, Germany, and studied at Heidelberg. He began studying law and even practiced for some time in Hamburg. His practice was unsuccessful and Schleiden attempted suicide. He aimed a pistol at his head but missed, only grazing his scalp.

Schleiden returned to the University to study botany and medicine, eventually earning doctorates in medicine and philosophy. He became a professor of botany at Jena University in Germany, but after twelve years resigned and spent the rest of his life wandering the German countryside. Schleiden would talk to anyone he could find expressing his theories of biology but, few listened.

He celebrated the 50th anniversary of his law degree, although he had not practiced law for 45 years. Fortunately, his wanderings brought him into contact with **Theodor Schwann** (1810–1882) in Berlin.

Like Paracelsus, Schleiden was unmerciful in his criticism of classical natural philosophers such as Linnaeus. He believed that biology had established no fundamental principles. Schleiden argued that only the chemistry and the physiology of plants were truly important. He dismissed biological classification as scientifically a *waste of time*.

Schleiden believed biology (botany in his case) must deal with the actual structures of plants and animals examined, especially with the microscope. Schleiden came to the conclusion that the plant cell was the key to understanding botany, and that the nucleus was the *universal elementary organ of vegetables*, which he renamed the *cytoplasm*. (See 14.4.)

Link 14.4 Plant Cell Showing Nucleus

<http://www.plant-biology.com/plantcelldiagram.gif>

Schleiden decided that within each plant, the cell led a double life. First, the cell enjoyed an independent development and structure; but, second, the cell served an integral function as part of the plant. Therefore, he concluded that all aspects of plant physiology, including comparative physiology, were fundamentally manifestations of the vital activity of cells.

Since cells were the ultimate unit of plant structure and function, the origin of the cells was a critical problem for Schleiden – not unlike the origin of species for Darwin. Schleiden could not work this out. He developed a theory called *free cell formation*. He thought that perhaps cells propagated somewhat like crystals. Importantly, Schleiden rejected all theories of spontaneous generation in favor of a biological mechanism.

In contrast to the abrasive, bombastic, heterodox Schleiden, Schwann was timid, introspective, and excessively pious. Schwann, a Prussian, was a broad biologist and his contributions give some sense of the great variety of activity and research in the mid-19th century. He discovered the sheath surrounding nerve fibers (named for him). He discovered the enzyme pepsin while studying digestive processes. Schwann determined that a chick embryo required oxygen. His experiments on fermentation challenged theories of spontaneous generation.

Schwann's major contribution to cell theory came as a result of his meeting with Schleiden, who excitedly described for Schwann the nature and function of the cell nucleus in plants as he had observed it. Schwann recalled seeing a similar structure in the cells of the notochord, a rod of cells that in the embryo of chicks forms the supporting axis of the body.

Like Schleiden, Schwann found the nucleus the key to understanding the cellular structure of animals. In his microscopic studies Schwann had noted some similarity between plant and animal cells, but he was most impressed by their differences and by the great variety of animal cells compared with plant cells. Besides, it was difficult to see animal cells even with improved microscopes because they were generally quite transparent.

With Schleiden's help, however, Schwann understood that there was a certain unity in plant and animals cells, and that cells are the basis of all animal tissue, no matter how specialized. He published his findings in *Microscopical Researches into the Accordance in the Structure and Growth of Animals and Plants* (1839) in which he argued for the "most intimate connection of the two kingdoms of organic matter."⁵⁴

Still, the question remained as to what was the mechanism for the propagation of the cells, animal or plant? **Rudolf Ludwig Carl Virchow** (1821–1902) is generally credited with formulating cell theory in its modern form, and incorporating it into pathology as the foundation stone of scientific medicine. Virchow was also a Prussian who studied medicine at the University of Berlin and became a doctor there.



"I studied English for 16 years but...
...I finally learned to speak it in just six lessons"
Jane, Chinese architect

ENGLISH OUT THERE

Click to hear me talking before and after my unique course download

Virchow was a brilliant man of many talents, interests, and accomplishments, including being a participant in the intellectual and social movements of the late 19th century. Virchow first discovered and described *white blood*, or leukemia. He participated in the revolutions of 1848, and because of his political radicalism, found it expedient to leave Berlin for the University of Wurzburg where he obtained the chair of Pathological Anatomy. Ultimately, he returned to Berlin to head the famous Institute of Pathology. Again he engaged in politics, gaining election to the Berlin City Council, and the Prussian Diet.

He served on the Berlin City Council for the remainder of his life and was responsible for social, sanitary, and medical reforms in the city. During the wars of 1866 and 1870, Virchow was responsible for the organization of the first hospital trains and military hospitals in Germany. He was also an anthropologist, and founded the Berlin Society of Anthropology, Ethnology, and Prehistory, serving as President until his death.

Virchow's contributions to cell theory principally concern us here. Reflecting on the work of Schleiden and Schwann, and following up on work of Robert Remak, a Polish scientist, Virchow focused on the issue of cellular propagation. He not only rejected spontaneous generation, but also Schleiden's free cell formation theory.

Virchow concluded that in normal growth cells propagate from the division of parent cells. That is, that all cells are produced from existing cells. There is no other place for cells to arise. Furthermore, diseased cells also grow or multiply from pre-existing cells. He vigorously opposed the ancient idea of *general disease*. Instead, the question of pathology was *where in the body's cells is the disease?* Virchow argued that there is no essential difference between normal and pathological states. That is, all disease is simply modified life or cells. For example, extensive studies of cancer convinced Virchow that cancer cells differ from normal cells primarily in behavior rather than in structure. (See Link 14.5.)

Link 14.5 Cell Reproduction

<http://bit.ly/19HSm58>

There would be a good deal more to learn about cell structure and behavior before the end of the century. By 1870, scientists identified the first steps in cell division in the nucleus (mitosis), and by the end of the century, using new staining techniques, chromosomes were discovered and their key function as agents of reproduction were identified.

These developments in cell theory and pathology paralleled discoveries of bacteria and viruses to which much was owed to Louis Pasteur for the germ theory of disease; and to Robert Koch for the discovery of the tuberculosis bacillus; and Joseph Lister for the principle of antiseptics. In addition, advances in anesthetics made diagnostic and corrective surgery feasible.

Cell theory and physiology, of course, led directly to the question of what happened when cells divided. How do dividing cells contribute to the survival and evolution of the larger organism?

14.2 Genetics

Genetics was first studied scientifically by **Gregor (Johann) Mendel** (1822–1884) in the 1860s. (*Johann* was his given name and *Gregor* his religious name.) Mendel was an Austrian monk who grew up on a farm and studied at the Philosophical Institute in Olomouc from 1840 through 1843. Then he entered the Augustinian Abbey of St. Thomas in Brno. (Brno is now in the Czech Republic but was part of the Austrian Empire at that time.)

Mendel grew and studied 29,000 pea plants from 1856 through 1863. For his experiments, he selected the common pea plant, and in preliminary testing identified seven pairs of characteristics for study. (See Link 14.6.)

Link 14.6 Mendel's Pea Characteristics

<http://mac122.icu.ac.jp/gen-ed/mendel-gifs/03-mendel-characters2.JPG>

- Form of Ripe Seed: Smooth or Wrinkled
- Color of Seed Albumen: Yellow or Green
- Color of Seed Coat: Grey (red flowers) or White (white flowers)
- Form of Ripe Pods: Inflated or Pinched
- Color of Unripe Pods: Green or Yellow
- Position of Flowers on Stem: Axial or Terminal
- Length of Stem – long or short

Note that Mendel, as Darwin, was interested in domestic selection, breeding, varieties, and hybrids. Mendel carefully studied hybrids produced by crossing different varieties of pea plant. His was a painstaking researcher that paid close attention to detail. His experiments took more than eight years to complete. During that time, Mendel read *On the Origin of Species* and commented: “It requires some courage to undertake a labor for such far-reaching extent; this appears, however, to be the only right way by which we can finally reach the solution of a question the importance of which cannot be overestimated in connection with the evolution of organic forms.”⁵⁵ Mendel was clearly aware of the larger issues of his great work, and anticipated the impact his research would have on the theory of natural selection and evolution.

Mendel discovered that when he crossed one pure pea plant with the other, the hybrid tended to look exactly like one of the parent plants. (There had been a great deal of speculation that offspring were a *mixture* of parentage, even with the Ancient Greeks. This certainly seemed to be so in the human race, where black and white produces various shades of brown.) What Mendel observed was that some characteristics were transmitted virtually intact, with little change, while others seemed to disappear, also completely. He called the former characteristics or traits *dominant*, and the latent characteristics or traits *recessive*.

The vocabulary of dominant and recessive characteristics is now commonplace and we know that if we cross yellow and green peas, the first generation will have all yellow seeds because that trait is dominant. So S=Yellow (dominate) and G = Green (recessive):

1st Generation:	YY GG	1Yellow and 1Green
	YG YG YG YG	4Yellow
2nd Generation:	YG YG	2Yellow
	YY YG YG GG	3Yellow and 1Green

In summary, in subsequent generations of hybrids, the recessive trait will re-emerge in a dominant-to-recessive ratio of about three-to-one.

In the past 5 years we have drilled around
95,000 km
 —that’s more than **twice** around the world.

Who are we?
 We are the world’s leading provider of reservoir characterization, drilling, production, and processing technologies to the oil and gas industry.

Who are we looking for?
 We offer countless opportunities in the following domains:

- Operations
- Research, Engineering, and Manufacturing
- Geoscience and Petrotechnical
- Commercial and Business

We’re looking for high-energy, self-motivated graduates with vision and integrity to join our team.

What will you be?

Schlumberger

careers.slb.com



Mendel experimented with all seven of his traits and characteristics, and determined that all seven recessive traits reappeared in the same ratio of 1:3. In his own words: “all reappear in the numerical proportion given, without any essential alteration. *Transitional forms were not observed in any experiment.*”⁵⁶

Mendel carried his experiments into several generations, and determined that the ratios always remained the same. He concluded: “If A be taken as denoting one of the two constant characters, for instance the dominant, a , the recessive, and Aa the hybrid form in which both are conjoined, the expression $A^2 + 2Aa + a^2$ shows the terms in the series for the progeny of the hybrids of two differentiating characters.”⁵⁷

Two or more pairs of characters, independent of the others, yield similar, but more complicated equations. Mendel showed that: “All constant combinations which in Peas are possible by the combination of the said seven differentiating characters were actually obtained by repeated crossing. Their number is given by $2^7 = 128$. Thereby is simultaneously given the practical proof *that the constant characters which appear in the several varieties of a group of plants may be obtained in all the associations which are possible according to the (mathematical) laws of combination, by means of repeated artificial fertilization.*”⁵⁸

Mendel first published his results in 1866 in the Proceedings of the Natural History Society of Brno. Said Mendel in his introduction: “Experience of artificial fertilization, such as effected with ornamental plants in order to obtain new variations in color, has led to the experiments which will be here discussed. The striking regularity with which the same hybrid forms always reappeared whenever fertilization took place between the same species induced further experiments to be undertaken, the object of which was to follow up the developments of the hybrids in the progeny.”⁵⁹

Mendel was probably the first biologist to work out a detailed application of mathematics to biology. Of course, he had no idea of the mechanism by which the Pea traits were transmitted. (Mendel’s work has this in common with other mathematical models which describe or measure mathematical regularity in nature without revealing the mechanism by which change occurs. e.g. Newton’s Law of Gravity of Coulomb’s Law of Electrostatic Force.)

Mendel’s work was ignored for more than 30 years because it appeared in an obscure publication. In 1868, Mendel became Abbot of his monastery, and had to forgo his time-consuming experiments. On his death in 1884, the new Abbot burnt Mendel’s remaining papers. It is interesting to contemplate what might have happened if Darwin had known Mendel’s work. It seems likely that Mendel’s genetics would have been important support for Darwin’s natural selection.

William Bateson (1861– 1926), discovered Mendel’s work in 1900. Bateson, who had attended Cambridge and studied morphology, translated Mendel’s original papers into English and published *Mendel’s Principles of Heredity: A Defence* in 1902. Mendel’s work was not immediately embraced, in part because it focused on plants at a time when the principle scientific interest was in human inheritance.

But steadily, biologists were won over by Mendelian genetics. A good example is **T.H. Morgan** (1866–1945) who initially was critical of Mendel's ideas. Morgan thought that Mendel's studies might apply to plants but not to animals. Morgan did not believe that the categories *dominant* and *recessive* were clear cut. For example, sex was almost equally distributed between male and female but if sex (male vs. female) were selected like pea seed color, one sex should be dominant and occur with a 3:1 ratio over the other.

Morgan studied the fruit fly, *Drosophila*, a species that bred every ten days or so. *Drosophila*'s normal eye color was red, but occasionally white eyes occurred and Morgan discovered that the eye color followed Mendel's rules. (See Link 14.7.)

Link 14.7 Morgan's *Drosophila* Generations

<http://media-2.web.britannica.com/eb-media/04/114704-004-8F8024ED.gif>

Morgan's group at Columbia University developed the technique of observing and mapping the changes in *Drosophila* chromosomes under the microscope. This work led to the historic publication in 1915 of *The Mechanism of Mendelian Heredity* by Morgan, A.H. Sturtevant, and C.B. Bridges. Morgan's research firmly established Mendelian principles with biologists.

Morgan's studies led rather naturally to the development of population genetics, which was an area researched especially strongly in the Soviet Union in the 1920s. Morgan's laboratory shared pure-bred *Drosophila* stocks with a group of Russian scientists who determined evolution would occur more rapidly in isolated populations. Sergei Chetverikov of the Koltsov Institute in Moscow published *On Several Aspects of the Evolutionary Process from the Viewpoint of Modern Genetics* in 1926.

Finally there was a marriage between Darwin and Mendel. It was unfortunate that Darwin never learned of Mendel's work. Experimental proof of Mendelian inheritance would have given importance support to evolutionary theory. While Mendel knew of Darwin and read his works, we must assume that he did not realize that his medium of publication, The Proceedings of the Natural History Society of Brno, was not widely known. Biology might have progressed more rapidly if Mendel and Darwin had communicated.

Subsequently, the main focus of genetics – and a major focus of biology itself – has been to seek an understanding of the biochemical basis of inheritance. (This field is now known as *molecular biology*.) Three landmark achievements have occurred in molecular biology. These were: the elucidation of the structure of DNA (See *The Double Helix*); the discovery of the mechanism by which the DNA molecule replicates itself during cell division; and, understanding how DNA controls the structure of the proteins made by cells.

14.3 DNA (deoxyribonucleic acid)

A development in physics that was essential to the elucidation of the structure of DNA and its functioning was the invention of *X-Ray Crystallography*. The father and son team of W.H. Bragg (1862–1942) and W.L. Bragg (1890–1971) were studying the behavior of X-rays when shined on crystals. Through a series of clever experiments, the son determined a mathematical relationship between the wavelength of the X-rays and the distance between the atoms in a crystal. (See Link 14.8.)

Link 14.8 X-Ray Diffraction

<http://imr.chem.binghamton.edu/labs/xray/xray.html>

$$n\lambda = 2d \sin\theta$$

where n is an integer, λ is the wavelength of X-rays, d is the distance between planes of a crystal and θ is the angle of diffraction.

Excellent Economics and Business programmes at:



university of
 groningen



“The perfect start
of a successful,
international career.”

CLICK HERE
to discover why both socially
and academically the University
of Groningen is one of the best
places for a student to be

www.rug.nl/feb/education

By measuring the angle of refraction for various orientations of a crystal and using complex mathematical relationships, it is possible to determine the arrangements of the atoms in a crystal structure. (This led to a field of chemistry known as *crystallography*.) By the time, **Francis Crick** (1930–2007) and **James Watson** (1928–) began their studies of DNA in the 1950s, crystallography had developed into an advanced science and it was common, though tedious prior to the development of high speed computers, to determine the crystal structures of simple compounds, typically those with fewer than 20 atoms.

Proteins, which are the building blocks of all living cells, carry the genetic information that allows accurate reproduction. Proteins are very large molecules made up of a series of smaller molecules called amino acids. There are 20 some amino acids found in nature and they all have both an amine end ($-\text{NH}_2$) and an acid end ($-\text{CO}_2\text{H}$). An example of an amino acid is: $\text{H}_2\text{NCHR}\text{CO}_2\text{H}$ where R is some other organic functional group such as $-\text{CH}_3$ or $-\text{CH}_2\text{SH}$. For example if R is $-\text{CH}_3$ the amino acid is *alanine* and if R is $-\text{CH}_2\text{SH}$ the amino acid is *cysteine*. (See Link 14.9.)

Link 14.9 Amino Acids

<http://bit.ly/13EkxiE>

Glycine	R = H
Alanine	R = CH ₃
Valine	R = CH(CH ₃) ₂
Serine	R = CH ₂ OH
Cysteine	R = CH ₂ SH

All amino acids have the same basic structure, an acid group at one end and an amine group at the other. The R functional group determines the particular amino acid.

Two amino acids, $\text{H}_2\text{NCHR}_a\text{CO}_2\text{H} + \text{H}_2\text{NCHR}_b\text{CO}_2\text{H}$ can link by an acid-base reaction:

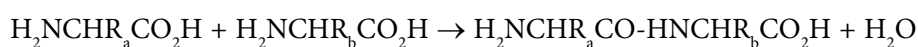

The resulting molecule is still an amino acid having the characteristic amine and acid ends. So, the process can continue indefinitely making a chain of any length. It is the order of the amino acids that determine the particular protein and its functionality. Typical proteins of importance in the biochemistry of life are made up of hundreds or thousands of amino acids.

In 1953, **Stanley Miller** (1930–2007) and **Harold Urey** (1883–1981) carried out an experiment at the University of Chicago where they mixed simple inorganic compounds that were thought to be present in the primordial Earth. Miller & Urey mixed methane (CH₄), ammonia (NH₃), hydrogen gas (H₂), water (H₂O), and carbon monoxide (CO) and applied electric arcs to the mixture to simulate lightning. After one week, they found 10–15% of the carbon was present as organic compounds and amino acids had been created in the solution. Miller and Urey clearly demonstrated that the components of proteins could easily be produced from inorganic compounds under natural conditions. They had extended Wöhler's synthesis of urea to the possible synthesis of proteins and all life chemicals.

Determining the structure of DNA was recognized as one of the greatest scientific challenges. Four individuals, working in the Cavendish laboratories, are credited with determining the structure by X-Ray diffraction. Crick and Watson, working in the diffraction laboratory of **Maurice Wilkins** (1916–2004) and aided by data from **Rosalind Franklin** (1920–1954) determined that DNA was folded in a double helix.

This structural information ultimately led to determining that the genetic code was carried by four different bases in DNA, adenine, cytosine, guanine, and thymine. It is the order of sets of three of these bases that allows DNA to select individual amino acids in the proper order when assembling proteins. (See Link 14.10.)

Link 14.10 Genetic Code

<http://www.mun.ca/biology/scarr/MGA2-03-28.jpg>

In 1962, Watson, Crick and Wilkins were awarded the Nobel Prize in Medicine & Physiology. An American scientific competitor, Linus Pauling, also shared his own X-Ray data with Crick and Watson probably aiding them considerably. We will talk in detail about Pauling in the chapter on the Chemical Bond.

Watson, who was a great writer as well as a great scientist, published a Pulitzer Prize winning book, *The Double Helix* in 1968 which you are urged to read. Watson's book is an excellent discussion of how science proceeds and is readable by any layman.

There has been much discussion as to whether Rosalind Franklin should have shared in the Nobel Prize instead of Wilkins. However, it is a moot point as Franklin died before the prize was awarded and thus she was not eligible.

15 Modern Cosmology – the Origin of the Universe (1900–)

There is no more exciting nor more significant development in science than modern cosmology. What greater question could we ask than how we came to exist? Whence the Universe? How and why are there galaxies and atoms; carrots and quanta; what does it all mean, if there is such a thing as meaning?

When the first cave man heard thunder in the mountains and wondered what kind of animal made such a noise, homo sapiens started on a journey to try to explain the universe. We have made fascinating progress, especially since Galileo used his telescope to disassemble the Milky Way into separate stars.

Before the Ancient Greeks began to apply logic to nature there were gods and demons. Our literature abounds with stories of supernatural beings: dragons in Asia; the Cyclops and the Minotaur in the Grecian islands; fairies and sorcerers in medieval Europe; and genies in Arabia. The only way a princess could get a date in medieval times was to go around kissing frogs!

American online
LIGS University
is currently enrolling in the
Interactive Online **BBA, MBA, MSc,**
DBA and PhD programs:

- ▶ enroll **by September 30th, 2014** and
- ▶ **save up to 16%** on the tuition!
- ▶ pay in 10 installments / 2 years
- ▶ Interactive Online education
- ▶ visit www.ligsuniversity.com to find out more!

Note: LIGS University is not accredited by any nationally recognized accrediting agency listed by the US Secretary of Education. More info [here](#).





We learn what we learn about the universe from light and almost all of our natural light comes from a nearby star we call the *Sun*, either directly or by reflection off the Moon. With our eyes we can see a few thousand stars and five other planets that orbit the sun like the Earth. But, we didn't look very closely until about 1600. We didn't notice, for example, that the Moon has an irregular surface and we tried to ignore the fact that the planets go back and forth rather than moving in circles like the stars. So we developed an inaccurate astronomy that, for religious reasons, claimed that all the heavenly bodies travelled in perfect circles, were themselves perfectly round and smooth, and all orbited the Earth. That last rule was clearly egotistical because it made not only the Earth, but also man, the center of the universe. Western religions are mostly built on the theme that not only is man the center, but that the entire universe was created for man.

Even brilliant individuals like Ptolemy, who realized the positions of the stars could be used for navigation, developed hopelessly complex mathematical models to maintain this inaccurate astronomy. The practice extended all the way to Copernicus who, although he had the courage to develop a heliocentric model for the solar system, still insisted on maintaining circular orbits.

It is hard to imagine that we would never have moved beyond this inaccuracy if the telescope had not been invented. In fact, Tycho's very accurate pre-telescopic observations contained sufficient data to support heliocentricity and elliptical orbits. But, it was certainly easier to build a much improved astronomy when we learned how to magnify light by focusing it with lenses and later with mirrors. The telescope was just what Galileo needed and Galileo was just what the telescope needed for science to make a leap forward in disproving these heavenly myths and start us on a path towards understanding the universe.

In a little over 100 years, the genius of Copernicus, Kepler, Galileo and Newton removed most of the mythology from astronomy. The sun became just another star, stars became just other suns, and gravity ruled the behavior of rocks and Moons with one unifying, universal law.

By Newton's time the idea that the universe was infinite and contained an infinite number of stars was accepted. But this led to problems in physics, how does one deal with an infinite amount of radiation or infinite mass?

15.1 Galaxies and Cepheids

Galileo discovered that the Milky Way is a collection of stars (galaxy) spread out as a disk over a very large space. (The Milky Way is about 100,000 light years across and contains 200–400 billion stars.) In the 18th century the astronomer William Herschel and the philosopher Immanuel Kant had identified other patches of light seen by Galileo as galaxies, but it was not until 1920 that the American astronomer **Edwin Hubble** (1889–1955) was able to resolve other galaxies into stars using the 100-inch telescope at Mt. Wilson in California.

Measuring the distances to stars was very difficult because it had to be done by stellar parallax. 1 second of 1 minute of 1 degree (1 parsec) measures a distance of 3.26 light-years. And, there are only 11 stars, not counting the sun, within 10 light-years of Earth.

Then in 1908–12, **Henrietta Leavitt** (1868–1921), working at the Harvard observatory, determined that there was a relationship between the mass (and thereby absolute intensity) and pulsation rate of certain stars called Cepheids or Cepheid variable stars. Because the absolute intensity could be determined, the measured intensity allowed calculation of the distance of the star as the measured intensity falls off as the square of the distance. Cepheids pulse because they are large stars that are expanded by their heat and pulled back by their own gravity. Since the rate of pulsing is proportional to their absolute intensity, by calibrating with nearby stars, Cepheids in galaxies can be used to measure much greater distances.

Leavitt was the daughter of a Congregational minister. She had attended Oberlin College and then graduated from Radcliffe College very interested in astronomy but then stayed home because of a severe illness. She lost most of her hearing and, upon regaining her health, applied to work at the Harvard observatory. She was hired to do a menial job determining the intensity of stars on photographic plates. It was this task that exposed her to the Cepheid data and led to one of the most important discoveries in astronomy. A decade later Hubble discovered Cepheids in other galaxies and used this information to calculate the distances of the galaxies from Earth.

15.2 General Relativity and Black Holes

In 1915, **Albert Einstein** presented his General Theory of Relativity. In General Relativity (GR), gravity is explained by the warping of space by matter. This effect is only measureable in very high gravity situations, such as near stars, but explained a well-known difference in the orbit of Mercury from that calculated with Newton's gravitational law. The theory was further verified by the measurement of light being bent by the gravity of the sun during an eclipse in 1919.

In GR, space is curved but finite. (Consider the perimeter of a circle, it has no limit but is still finite. Einstein's GR says that three dimensional space is curved – a concept hard to imagine – and to get the correct picture we must work in a four dimensional space-time.

Einstein's theory, however, had the problem that gravitational attraction should cause the entire universe to collapse. Einstein added a factor called the cosmological constant that would keep this from happening. (He later called this his biggest mistake.) However, Einstein's GR solved many problems and slowly became widely accepted. As a result of GR, Einstein's universe would be static and finite, and not the infinite universe of Newton.

In 1916, Karl Schwarzschild using Einstein's general relativity, proposed that if a star had sufficient mass, it could collapse into a black hole where even radiation could not escape. (In 1970, Stephen Hawking developed a quantum mechanical mechanism whereby black holes could eventually lose matter and decay below the critical mass. And, in 1971, C.T. Bolton detected a black hole in Cygnus X-1.)

In 1923, Hubble resolved the Andromeda Galaxy into stars and calculated its distance at 1 million light years. (We now know there are billions of galaxies.)

15.3 The Redshift and the Big Bang

As early as 1914, **Melvin Slipher** (1875–1969) had reported that the spectra from galaxies were redshifted. The Doppler Effect was known for sound and an analogy for light would mean that a redshift occurs when bodies are moving apart very rapidly. Even though the speed of light is not changed when one body is moving away from another, the maximums and minimums in the light-wave arrive less often resulting in a decrease of frequency. Thus the light moves towards the red end of the spectrum. (It would be a green shift if they were moving towards each other.) (See Link 15.1.)

Link 15.1 The Redshift

<http://bit.ly/1d5XZvl>

DON'T EAT YELLOW SNOW

What will your advice be?

Some advice just states the obvious. But to give the kind of advice that's going to make a real difference to your clients you've got to listen critically, dig beneath the surface, challenge assumptions and be credible and confident enough to make suggestions right from day one. At Grant Thornton you've got to be ready to kick start a career right at the heart of business.

Sound like you? Here's our advice: visit GrantThornton.ca/careers/students

Scan here to learn more about a career with Grant Thornton.

 **Grant Thornton**
An instinct for growth™

© Grant Thornton LLP. A Canadian Member of Grant Thornton International Ltd

If the source of a spectrum (in this case, a star producing a hydrogen spectrum) is moving away very rapidly, each wave maximum is emitted at a farther distance from the observer. This means that the waves arrive at the observer less often than they were emitted. Thus the arriving radiation has a lower frequency and, if it is visible light, is shifted towards the red end of the spectrum. (In the visible spectrum, the highest frequency-shortest wavelength light is violet and the lowest frequency-longest wavelength light is red.) In the example above, the wavelengths of the hydrogen lines, are all redshifted indicating the supercluster of galaxies is moving away from us at 0.07 times the speed of light.

Hubble was working on classifying galaxies when he noticed that the spectra from every galaxy were redshifted. This could only be true if every galaxy was moving away from every other one. (Think of putting a bunch of dots on a balloon and blowing up the balloon. As the balloon expanded, every dot would get farther away from every other dot.) In 1929, Hubble proposed the universe was expanding based on these data. Einstein had claimed a static universe to satisfy his proof that the universe was finite, but he accepted Hubble's argument that the universe was expanding.

The extent of the redshift is determined by the velocity with which two bodies are moving apart. Thus, it is possible to determine the speed of a galaxy by its redshift and the distance by measuring Cepheids within the galaxy. By extrapolating backwards it is possible to determine that all measureable galaxies were once at the same location. Hubble's original calculation gave an age for the universe of 1–2 billion years. However, with the much better data that has been collected in the last 80 years, the age of the universe is now determined to be 13.7 billion years.

In 1931, **Georges Lemaitre** (1894–1966), a Belgian Catholic Priest and Professor of Physics and Astronomy, following on the idea of an expanding universe, published a paper proposing that there had been a single primeval *atom* that had exploded to form the galaxies. But, will the universe always expand? If so, there must be an infinite place into which to expand. In 1932, Jan Oort, in Holland, calculated the mass that would be required for gravity to make the universe eventually stop expanding and then collapse. He found that there had to be additional mass at least equal to the observable mass. He proposed that there must be a great deal of dark matter, mass we cannot see. (We now estimate the dark matter to make up about 90% of the mass of the universe. One of the initial goals of the Hubble telescope was to find the dark matter.)

In 1932, commercial radio was in its infancy. A major problem with the AM (amplitude modulation) method of radio transmission was static noise. (Switch your car radio to AM and play with the tuning knob and you will see what I mean.) Bell Laboratories, in Murray Hill, New Jersey, set out to find out why there was static in radio. Interestingly, it was noticed that static was worse in the daytime than at night. Karl Jansky (1905–1950) built directional antennas and found several sources of static including the constellation Sagittarius which is near the center of our galaxy. Obviously stars were producing radio waves and he found that the sun was a major source of static. That is, intense radio waves were coming from the sun.

The science community ignored Jansky's discovery but in 1937, an American radio engineer, Grote Reber, built the first radio telescope in his back yard. He made a 31 foot parabolic reflector to concentrate the radio signals onto an antenna and made the first radio map of the sky. (There are many stars which cannot be seen by visible light but can be detected by their radio waves.) Following World War II, radio-telescope has been greatly advanced.

A Cambridge group in 1948, Bondi, Gold and Hoyle proposed the continuous creation and destruction of galaxies to give a steady state universe. Hoyle was a major critic of the Lemaitre idea of the universe starting from a single point, but he inadvertently gave the theory the catchy name *Big Bang* as he was deriding it on a radio program. And, it was also in 1948 that **George Gamow** (1904–1968) suggested the initial explosion that we now call the big bang. Also in 1948 Alpher and Herman proposed a model in which the universe would initially be concentrated at a single point with a temperature so high that not even atoms would exist. (We will describe this model a little later.) As the universe expanded and cooled, particles would come into existence, eventually atoms, and so forth. If their model was correct there should actually be radiation (microwave) of the background temperature of the universe which is about 5 Kelvin. (Remember that 0 Kelvin is absolute zero, about -459 °F or -273 °C.)

In 1964 Wilson and Penzias at Bell Laboratories discovered the microwave background radiation which we can now be measure in all directions. The actual temperature is around 2.7 Kelvin, a remarkable agreement with theory. Further modeling of stars suggests some interesting results. As a star burns out it should collapse, losing its electrons and then its protons and become a very massive neutron star. If it is sufficiently massive, it will continue to collapse and become a black hole.

A big bang is what is called a *singularity* in physics. It is another way of saying the laws of physics change at that moment. A major argument against the Big Bang is that it requires a singularity as currently formulated. On the other hand, quantum mechanics gives rise to virtual particles through the uncertainty principle. If quantum mechanics can eventually explain gravity – it already explains the other three forces, electrostatic, weak and strong forces – then no singularity is required. Quantum gravity is now one of the forefronts of physics.

Steven Weinberg (1933–), an American Nobel Laureate in Physics, models the Big Bang in his excellent book: *The First Three Minutes* (1977). The following is condensed from Weinberg's Chapter V:

1. Starting at zero time and infinite temperature, after about .01 seconds the temperature is 10^{11} K. There are only a small number of nuclear particles compared to photons and electrons and neutrinos.
2. After 0.11 seconds the temperature is 3×10^{10} K and neutrons can turn into protons.
3. After 1.09 seconds the temperature is 10^{10} K and we have a majority of protons among the nuclear particles. It is still too hot for nuclei to form.
4. After 13.82 seconds the temperature is 3×10^9 K and electrons and positrons are starting to disappear. Nuclei can form. Hydrogen and helium isotopes are forming.
5. After 3 minutes and 46 seconds, the temperature is 10^9 K deuterium nuclei are forming but still breaking apart. But soon the temperature reaches the point that deuterium holds together and larger nuclei form.
6. After 34 minutes and 40 seconds the temperature is 3×10^8 K, electron-positron annihilation has ended and there is a slight excess of electrons to balance the charge of the protons. Cooling continues for 700,000 years and then atoms start to form. At this point, matter condenses and stars and galaxies can be created.
7. After 10 billion years we start to try to figure it out.

As of this writing, science has not definitively proven which kind of universe we have: a Big Bang universe or a static, eternal universe.

16 The Chemical Bond (1900–)

In the 19th century, as chemistry and biology developed, for the first time science explained microscopic and, in the case of chemistry, the submicroscopic, properties and behavior of matter. Lavoisier and Dalton had made chemistry a science, Mendeleev showed there were relations among the chemical properties and reactivity of elements and Berzelius invented a language whereby chemistry could be reported and discussed.

The understanding of chemical bonding, most of which occurred in the 20th century, progressed with virtually no direct measurement of the molecules and atoms. Much like Dalton's atomic theory, bonding theory is one of the hallmarks of scientific reasoning.

As we know, Newton spent most of his research career unsuccessfully searching for the answer to *cohesion*, that is, what held matter together. However, Newton preceded Dalton and others who gave the first firm foundations to chemistry. Without the atomic concept for a beginning point, it is unlikely that Newton could have arrived at a satisfactory theory.

.....Alcatel-Lucent 

www.alcatel-lucent.com/careers

What if you could build your future and create the future?

One generation's transformation is the next's status quo. In the near future, people may soon think it's strange that devices ever had to be "plugged in." To obtain that status, there needs to be "The Shift".

All Newton had to work with as a force was gravity and gravity is a *very* weak force. If we stand next to a massive object, like a locomotive or elephant, we do not feel the pull of gravity towards that object. Given the very small force of gravity, a microscopic theory to explain such obvious cohesions as water forming into droplets in the air based on gravitational attraction is clearly implausible.

Then, in the 1780s, a French military engineer named Charles Augustin de Coulomb, demonstrated with the use of a torsion balance, that the forces of electrostatic attraction and repulsion also are a function of the inverse square of the distance. Hence, Coulomb's law joined Newton's law in physics. Furthermore, the much stronger electrostatic force, about 38 orders of magnitude stronger, could be a reasonable candidate for holding materials together. (We have all noted the strength of electrostatic forces by such observations as fabric or paper sticking together; a rubbed balloon holding itself to the ceiling; and an electric arc generating heat, light and shock as it leaps from your finger to the door knob on a cold winter day.) (See Link 16.1.)

Link 16.1 Electrostatic Attraction and Repulsion

<http://bit.ly/14UySSa>

Like charges repel and unlike charges attract. The force between charges is proportional to the two charges and decreases by the square of the distance between them.

Because metal atoms from molten salts collected at the negative electrode (cathode) and non-metal atoms from elements such as oxygen and chlorine collected at the positive electrode (anode), Berzelius concluded that electrical forces must be involved in chemical affinity. In the early 19th century he proposed that all elements had both a positive and negative charge but that one was stronger than the other. Only oxygen was totally negative. Berzelius surmised that chemical bonding was the attraction between atoms of different charge. This idea was very sensible and even today we think of the periodic table divided into two groups, the metals, which predominately form cations (positive ions), and the non-metals, which usually form anions (negative ions.) It was an empirical theory with obvious problems. However, as nothing better was offered, it was largely accepted, even to the extent of interfering with greater understanding. For example, Berzelius's bonding theory could not permit a molecule composed of two atoms of the same kind because they would repel.

Berzelius, by the way, was a poor boy from Sweden, who grew up on his step-father's farm. For years he worked on the farm, living in the potato storehouse. His pay, for all the time he worked on the farm, was four dollars and a pair of stockings. He left to attend high school with the goal of becoming, perhaps, a clergyman. But, at school he became interested in nature. He collected birds and insects, even buying a gun so that he could shoot birds and find new species. He almost killed one of sons of a widow he was tutoring and was forbidden use of the gun. He ignored the warning and continued to collect birds to the extent that he cut his Hebrew class 63 times. He was graduated, but with stern warnings. At Upsala he became interested in chemistry and studied from the cheapest book he could buy, a German textbook on Lavoisier's anti-phlogiston chemistry.

He tried to get his professor to let him work in the laboratory and the professor sought to discourage him by ordering him to read a large collection of books on pharmacy. Berzelius read them and asked again to use the laboratory. He was allowed to use it when other students were gone. Berzelius also rented another student's room and used it for experiments. At the time he was finishing his University work, Volta invented the electric battery and Berzelius immediately involved himself in electrical work in solutions. As we know, Berzelius went on to become the guru of his generation of chemists and gave us the first chemical algebra in which Dalton's atoms were balanced in equations. Berzelius had set out to analyze every known chemical compound, and from all the knowledge he gained, he became the most important chemical consultant of his time. (Goethe and Berzelius were friends and admirers.)



Join the best at
the Maastricht University
School of Business and
Economics!

Top master's programmes

- 33rd place Financial Times worldwide ranking: MSc International Business
- 1st place: MSc International Business
- 1st place: MSc Financial Economics
- 2nd place: MSc Management of Learning
- 2nd place: MSc Economics
- 2nd place: MSc Econometrics and Operations Research
- 2nd place: MSc Global Supply Chain Management and Change

Sources: Keuzegids Master ranking 2013; Elsevier 'Beste Studies' ranking 2012; Financial Times Global Masters in Management ranking 2012

Maastricht University is the best specialist university in the Netherlands (Elsevier)

Visit us and find out why we are the best!
Master's Open Day: 22 February 2014

www.mastersopenday.nl



Click on the ad to read more

Later in the 19th century, **Svante Arrhenius** (1859–1927) developed his theory of solutions and explained the Berzelius charge problem. It was known that pure water conducted only a small current and a pure salt, such as sodium chloride, conducted no current at all. However, when sodium chloride was dissolved in water, conductivity became very high. Arrhenius's theory was that molecules dissolved in water to give ions. ($\text{NaCl} \rightarrow \text{Na}^+ + \text{Cl}^-$) Arrhenius also devised the first theory of acids and bases. According to Arrhenius, acids were compounds that produced H^+ in solution and bases produced OH^- . These two combined to make water. ($\text{H}^+ + \text{OH}^- \rightarrow \text{H}_2\text{O}$) Hence, acids and bases reacted to make neutral water and a salt that was ionized in solution and conducted a current. (See Link 16.2.)

Link 16.2 Ionic Conduction in Solution

<http://bit.ly/181TMAy>

As we discussed earlier, in 1897 J.J. Thomson identified the electron. And, in scattering experiments conducted from 1907 to 1911, Rutherford discovered the nucleus of the atom. Atoms, therefore, were known to have a massive, positive nucleus surrounded by negative electrons whose mass was only about 1/2000th of a hydrogen atom. (See Link 16.3.)

Link 16.3 Structure of Hydrogen Atom

<http://bit.ly/181TKZq>

The simplest atom, hydrogen, has a nuclear charge of plus 1 and has 1 negative electron which makes the atom neutral. (It is common, but wrong, to show the electron(s) orbiting the nucleus, as we will learn in quantum mechanics,

15.4 Molecular Bonding

A very simple picture of molecular bonding was possible using Coulomb's Law. Two positive nuclei, with negative electrons between, would have more attractive force than repulsive force. (See Link 16.4.)

Link 16.4 Simple H₂ Molecule

<http://bit.ly/13PXtrO>

The simplest molecule is two hydrogen nuclei sharing a single electron (H₂⁺). With the electron somewhere between the two nuclei, the attractive forces of the electron to each nuclei will be stronger than the repulsive forces between the two nuclei. (Remember, electrostatic force decreases as the square of the distance. The electron is closer to each nucleus than the nuclei are to each other.)

Hence, correct placement of electrons could account for the bonds that hold molecules together. But, as we have discussed, a Newtonian model of the atom does not work. If a negative electron were to orbit a positive nucleus, then the electron should spiral down to the nucleus losing its energy by radiation, until the atom collapsed. Even arguments of repulsion by the electrons are insufficient since the stable hydrogen atom is known to have but a single electron. The only hope for understanding atomic structure and chemical bonding is a different kind of mechanics.

As we have described, Bohr postulated quantum mechanics and Schrodinger developed wave mechanics that, combined, give us our present understanding. Bohr made an interesting analogy: if we picture the atom as large as the New York Empire State Building, the electron, the size of a marble, would be spinning around the building seven million times every millionth of a second. And that there was more empty space in the atom than between the planets in the solar system. The great mathematician and philosopher, Bertrand Russell, expressed this idea as: “Science compels us to accept a quite different conception of what we are pleased to call ‘solid matter’; it is in fact something much more like the Irishman’s net, ‘a number of holes tied together with pieces of string.’ Only it would be necessary to imagine the strings cut away until only knots were left.”⁶⁰

Applying quantum mechanics to molecules requires large computational capabilities. Complete solutions only started to become available in the 1960s with the advent of large scale computers. However, approximation methods continued to make useful progress in chemistry.

Gilbert Newton Lewis (1875–1946) of the University of California had already won the Davy Medal of the Royal Society for contributions to thermodynamics. Lewis, born in Weymouth, Massachusetts, was 10 years older than Bohr and was educated at Nebraska, Harvard, Leipzig and Göttingen. In 1902 he conceived of the cubical atom. Lewis's atom expressed the octet rule in which atoms with completed octets were stable, either on their own (as in the noble gases) or in combination with other elements in compounds. This also gave rise to *shells* of electrons and finally, in 1916, Lewis proposed the *covalent bond* where pairs of electrons were shared between atoms to give completed octets. (See Link 16.5.)

Link 16.5 Lewis's Cubical Atom

<http://bit.ly/14Zcn5j>

The first complete row of the period table is elements Li, Be, B, C, N, O, F, and Ne. After the first two electrons complete the 1st shell these elements have the following numbers of electrons in their second shell, respectively: 1, 2, 3, 4, 5, 6, 7, 8. The configuration of 8 (Ne) is very stable. (No compound of Neon has ever been made.) F has enough electrons to fill 7 of the 8 corners of a cube. If two F atoms shared one edge of a cube, they would each have the neon configuration of 8 electrons around them.



Empowering People. Improving Business.

BI Norwegian Business School is one of Europe's largest business schools welcoming more than 20,000 students. Our programmes provide a stimulating and multi-cultural learning environment with an international outlook ultimately providing students with professional skills to meet the increasing needs of businesses.

BI offers four different two-year, full-time Master of Science (MSc) programmes that are taught entirely in English and have been designed to provide professional skills to meet the increasing need of businesses. The MSc programmes provide a stimulating and multi-cultural learning environment to give you the best platform to launch into your career.

- MSc in Business
- MSc in Financial Economics
- MSc in Strategic Marketing Management
- MSc in Leadership and Organisational Psychology

www.bi.edu/master

BI NORWEGIAN BUSINESS SCHOOL

EFMD EQUIS ACCREDITED



Click on the ad to read more

Irving Langmuir, an engineer, saw that elements helium and neon were stable elements as singular atoms. So, atoms that could mimic the electron configuration of these stable elements should also be stable. Langmuir clarified the idea of valence as the number of electrons that had to be borrowed or loaned to make an atom stable. Structures based upon stable electron configurations, called Lewis structures, take the chemist a long way in simple chemical bonding. For example, carbon with four outer electrons needs four additional electrons and can have four bonds; nitrogen with five outer electrons needs three additional electrons and can have, hence, three bonds; oxygen with six outer electrons can have 2 bonds; and fluorine with seven outer electrons needs only 1 bond. Notice the following compounds of hydrogen (which has one electron to share) with these elements are: CH_4 , NH_3 , H_2O , and HF . And, the next row of the periodic table works exactly the same way! (See Link 16.6.)

Link 16.6 Simple Covalent Compounds

<http://bit.ly/1d89ZLP>

By sharing electrons, all atoms can achieve a stable configuration. Hydrogen, which has 1 electron to share, can achieve a helium configuration of 2 electrons. A neon configuration of 8 outer electrons can be achieved by fluorine (which has 7 outer electrons) by sharing 1 electron; by oxygen (which has 6 outer electrons) by sharing 2 electrons; by nitrogen (which has 5 outer electrons) by sharing 3 electrons; and, by carbon (which has 4 outer electrons) by sharing 4 electrons. (Note that a dash – is used to represent two electrons.)

Simple organic chemistry can be constructed completely, even involving double and triple bonds, on the Lewis covalent bonding theory. Also, diatomic gases work with H_2 and F_2 each having a single bond, O_2 a double bond and N_2 a triple bond. (See Link 16.7.)

Link 16.7 Diatomic Gases

<http://bit.ly/1cZvXRT>

Each of the atoms has its outer electrons in the same configuration as helium or neon. However, not all properties are correctly predicted by these configurations. For example, O_2 gas has different magnetic properties than are predicted.

The Schrodinger wave equation and Bohr's quantum mechanics gave rise to accurate electron configurations. Four quantum numbers were needed and these were dubbed with the classical labels, n (principle quantum number or shell), l (angular-momentum quantum number), m (magnetic quantum number) and s (spin quantum number.) The rules are: $m = 1, 2, 3, \dots$; $l = 0, 1, 2, \dots, m - 1$; $m = -l, -(l-1), \dots, 0, \dots, l-1, l$; and $s = 1/2, -1/2$. Hence, the first shell can have only 2 electrons, the second can have 8, the third 18, the fourth 32 and so forth. The so-called orbitals (l quantum number) were also named from classical labels with $l=0$ called an s-orbital; $l=1$ a p-orbital; $l=2$ a d-orbital and $l=3$ an f-orbital. The shapes of the first two kinds of atomic orbitals are s =spherical and p =dumbbell. Now it becomes possible to talk of covalent bonding as the overlap of atomic orbitals; hybridization thereof, etc. (See Figures 16.8 and 16.9.)

Link 16.8 Atomic Orbitals

<http://bit.ly/14ZcttB>

Quantum mechanics predicts the probability density of electrons. Each atomic orbital can contain up to 2 electrons. The first orbital, which contains the lowest energy two electrons, is called $1s$ and is spherically symmetrical. (This means the electron has an equal probability of being anywhere in the spherical area.) The next 2 electrons will be in the $2s$ orbital, still spherically symmetrical. The next 6 electrons are in the $2p_x$, $2p_y$, $2p_z$ orbitals each of which is symmetric along one of the three spatial axes. (There will be 1 electron in each of the three p-orbitals before the second electron is added to any of them.)

Link 16.9 Orbital Overlap to Form Bonds

<http://bit.ly/19wmA7E>

The overlap between the $1s$ orbitals of two hydrogen atoms results in the formation of a chemical bond. The two electrons that populate this overlap are mostly between the two nuclei thereby holding them together to form the H_2 molecule.

This solved a particular problem in that simple compounds like O_2 in a purely Lewis structure had all paired electrons where experiments showed otherwise. (But, in the orbital picture, unpaired electrons, shown by paramagnetism in O_2 are predicted.)

Another great chemist, perhaps America's greatest scientist, made repeated contributions to the theory of bonding. **Linus Carl Pauling** (1901–1994) was born in Portland Oregon. He lived several years in the small town of Condon, Oregon, where his father ran a drugstore. Pauling was influenced by local cowboys and Indians. One of the cowboys showed him how to sharpen a pencil with a knife and the Indians taught him how to dig for edible roots. Pauling's father moved the family to Portland to open a larger drugstore but died at the age of 33 of a perforated ulcer. His mother, Belle, had economic problems and deteriorating health.

Pauling was greatly influenced by a friend, Lloyd Jeffries, who showed him that sulfuric acid would turn sugar into a black smoldering mass. Pauling read his father's chemistry books and took all the science courses at his high school and then quit without graduating because he was bored. He went on to Oregon Agricultural College in Corvallis (now Oregon State University) majoring in chemical engineering and graduating summa cum laude in 1922.

Need help with your dissertation?

Get in-depth feedback & advice from experts in your topic area. Find out what you can do to improve the quality of your dissertation!

Get Help Now



Go to www.helpmyassignment.co.uk for more info



Helpmyassignment



Pauling had taken leave from college to help out in his mother's financial problems and during this time read the papers of G.N. Lewis. Pauling went to the California Institute of Technology where he studied both chemistry and physics in graduate school. He married Alva Helen Miller who had been his student in Corvallis. Returning to Cal. Tech. he started publishing on crystal structures and in 1925 published a paper that all crystals, no matter how complex, would have zero entropy at absolute zero. This is the basis of the third law of thermodynamics.

From 1925 to 1927 Pauling was a Guggenheim Fellow studying quantum mechanics with Arnold Sommerfeld at the Institute for Theoretical Physics in Munich. He made major contributions to the concept of applying quantum mechanics to chemical bonding. He developed rules of electrostatic valence that help crystallographers select the most likely arrangements of crystals to test. Pauling represented the best blend of theoretical and empirical reasoning. (There is often a split between these approaches and, in my opinion, is much of the resentment often found between scholars in the natural sciences and those in the social sciences.)

In the 1930s Pauling published critical papers on his theory of bond hybridization. The most famous publication was his book: *The Nature of the Chemical Bond and the Structure of Molecules and Crystals*, which was derived from his 1939 George Fisher Baker Lectures at Cornell. In 1954 he won the Nobel Prize in Chemistry "for his research into the nature of the chemical bond and its application into the elucidation of the structure of complex substances."

Pauling also developed a theory of bonding for metallic crystals which amounted to shared orbitals spread over the entire crystal. This successfully accounted for properties of metals such as high electrical conductivity and malleability.

In 1949, Pauling became President of the American Chemical Society and took a very unpopular stance against nuclear arms development. He appealed to the United Nations to end nuclear testing presenting signatures of more than 9000 scientists from 44 countries. When Congress demanded he reveal the names of those who helped him collect the signatures and he refused, he could have gone to prison for content of Congress. (Pauling believed if he released the names, many scientific colleagues in countries like the USSR would be put in danger.) The State Department took away Pauling's passport and he was denied foreign travel for a number of years. He received the Nobel Peace Prize in 1962 and was ultimately allowed international travel again.

In many ways, Pauling was the quintessential scientist, a theoretician, experimentalist and empiricist of the first order. He was a man unimpeded by the thinking of others. He was to go on to contribute vastly to the determination of the structure of DNA, to the explanation of molecular diseases like sickle-cell anemia and vitamin C therapy. He even attempted to develop a new theory of nuclear structure in the 1960s but had little success there.

Linus Pauling was such a charming, charismatic character, that the first lecture I heard from him in 1959 is still fresh in my mind.

17 The Computer Revolution (1900–)

17.1 Counting, Numbers, and Calculation

Science is quantitative and seeks mechanisms that both explain and predict the behavior of the physical world. Therefore, calculation is very important to science. Theories can be supported or invalidated by experimental data but this often requires extensive calculation. The advent of computers, which became widely available in the last few decades of the 20th century, has provided scientists with computational capability that never existed before.

Counting preceded the invention of numbers and number systems. The oldest counting artifact is the Lebombo bone that dates to 35,000 BCE. The bone has 29 notches suggesting it was a calendar stick used for counting the days of the month. (A lunar month is approximately 29½ days.) (See Link 17.1.) Tally sticks, like the Lebombo bone, are the first known written records. Counting, or in the commercial sense, accounting may have been the origin of writing. Counting days and months is a way to predict seasons and determine when to store food, when to plant, and when to harvest. Commerce, in the form of trading, clearly requires inventory and counting. When agriculture developed and tribes could stay in one place, counting became important to land measurement.

Link 17.1 Lebombo Bone

<http://img209.imageshack.us/img209/3909/ishango2le8.jpg>

Number systems were developed by several civilizations including the Egyptians, Indians, and Babylonians. Early number systems did not lend themselves to mathematical manipulation. (Try multiplying Roman numerals like XI and VIII.) However, computation did develop as addition and subtraction are particularly necessary for commerce. (Egyptians could determine land areas and even solve quadratic equations that had real roots by drawing rectangles.) The decimal system we have today was an Arab-Indian invention of the 5th century CE.

As with so many things, the Ancient Greeks were the first to develop number theory. You will recall the work of Pythagoras, Euclid, Archimedes, Diophantus, and Ptolemy that was discussed earlier. While computation was difficult in the Greek number system, still they made astronomical measurements and developed numerical tables such as Ptolemy's *Almagest*, that could be used to predict star positions accurately for up to 1000 years. Also, remember how Archimedes could calculate π and solve other numerical problems. Archimedes actually proposed a number system in his treatise *Sand Reckoner* that could express numbers up to 8×10^{63} .

Computation

In Latin, there are two verbs *calcularre* and *computo*. *Calcularre* means to count or reckon. (*Calculus* meant a small stone used for counting. Calx and calcium are also derived from *calcularre*.) *Computo* means to count by a mathematical method or to reason or reckon together. (Computation and computer are derived from *compute*.)

The first known constructed counting device was the Chinese counting board which appeared about 400 BCE. This same device evolved over time and by about 1200 CE had become the abacus which is still in use today. It was the introduction of the abacus to Europe that permitted the establishment of international banking during the Renaissance. (See Figures 17.2 and 17.3.)

Link 17.2 Chinese Counting Board

<http://www.mathmojo.com/abacus/abax/abaxjpgs/Abax199.jpg>

Link 17.3 Modern Abacus

http://www.vyvy.org/main/sites/vyvy.org/files/abacus_touched.png



Brain power

By 2020, wind could provide one-tenth of our planet's electricity needs. Already today, SKF's innovative know-how is crucial to running a large proportion of the world's wind turbines.

Up to 25 % of the generating costs relate to maintenance. These can be reduced dramatically thanks to our systems for on-line condition monitoring and automatic lubrication. We help make it more economical to create cleaner, cheaper energy out of thin air.

By sharing our experience, expertise, and creativity, industries can boost performance beyond expectations. Therefore we need the best employees who can meet this challenge!

The Power of Knowledge Engineering

Plug into The Power of Knowledge Engineering.
Visit us at www.skf.com/knowledge

SKF

In 1614, a Scottish mathematician named John Napier, who had worked out approximate formulas for exponents, published a table of exponents he called *logarithms*. Napier's logarithms could be used to multiply and divide. ($\log_{10} 2 = 0.30103$; $\log_{10} 3 = 0.44712$; adding these two logs gives 0.77815 which is the \log_{10} of 6. Napier converted the problem of multiplying and dividing into the simpler problem of adding and subtracting.) Napier sent his tables to Kepler who used them in the analysis of Tycho's astronomical data. Only 8 years later William Oughtred, an English mathematician, marked logarithmic scales on two rulers that he could manipulate to multiply and divide. Oughtred had invented the slide-rule which was widely used by scientists and engineers until the pocket calculator became available. (See Figures 17.4 and 17.5.)

Link 17.4 Logarithm Table

<http://bit.ly/1f0XLRK>

Link 17.5 Slide Rule

<http://bit.ly/17341HU>

In 1642, Blaise Pascal, a French mathematician, built a mechanical adding machine that could add and subtract and, in 1693, Leibniz increased the capability of mechanical calculators to multiply and divide. The mechanical calculator became electro-mechanical in the late 19th century and then fully electronic with the development of micro-circuitry in the latter half of the 20th century. With the miniaturization of large-scale-integrated-circuits, the pocket calculator emerged and, even if a bit large for the *pocket*, it became a hand-held device of great convenience completely replacing the slide rule. (See Figures 17.6 and 17.7.)

Link 17.6 Pascal's Calculator

<http://bit.ly/181UcHe>

Link 17.7 Modern Pocket Calculator

http://farm1.static.flickr.com/33/40890499_629164fa72.jpg

There were also ancient tables and methods for calculating astronomical positions. The Ancient Greeks had mechanical devices such as the Antikythera device which was thought to be the first mechanical calculator. The Antikythera device was found in a shipwreck at the bottom of the sea among the Greek islands in 1901. It has been dated to about 100 BCE and was apparently used to determine astronomical positions of the solar system. (See Link 17.8.)

Link 17.8 Antikythera

http://paxarcana.files.wordpress.com/2008/07/antikythera_mechanism.jpg

Ptolemy's *Almagest* is a set of computational tables and formulas written in the 1st century CE for determining star and planet positions. No originals remain but, fortunately it was translated by the Arabs and rediscovered in the 12th century.

The *astrolabe* was an astronomical instrument which initially had two metal disks. One disk represented the Earth and the other the Celestial Sphere. The astrolabe could be used for navigation because if you knew the time, you could determine your latitude and vice versa. (See Link 17.9.)

Link 17.9 Astrolabe

http://www.agmgifts.co.uk/resources/astrolabe_5.jpg

The astrolabe may have been invented around the 2nd century BCE. It is possible that Ptolemy used one. The Arabs learned about the astrolabe from Greek writing and built more advanced instruments. The *sextant*, which is used in modern times for celestial navigation, evolved from one form of astrolabe. (See Link 17.10.)

Link 17.10 Sextant

<http://www.clipperlight.com/SEXTANTARTICLE/sextant2.jpg>

17.2 Mathematics and Digital Computers

Mathematics advanced rapidly after the Renaissance. And, as we will see, certain developments in mathematics were essential to the development of the digital computer. Descartes' timely invention of analytical geometry (1637) set the stage for Newton's calculus (ca 1665) to produce mathematical solutions that supported his mechanical explanations of the physical universe.

Swiss mathematician **Leonhard Euler** (1707–1793), more than any other, systematized Newton's physics. Euler was probably the most prolific mathematicians of all time. He was also among the greatest. (Many consider German Karl Friedrich Gauss to be *the* greatest mathematician of all time.) Most of his life Euler published on the order of 400 pages of original mathematics every year. The irrational mathematical constant e (2.71828...) is named after Euler. (e is the base for natural logarithms and occurs in many fundamental equations in science.)

Euler had various medical problems with his eyes and eventually went blind. However, he had memorized all the major mathematical works and continued to publish by dictating to several secretaries. No longer burdened by his poor eyesight that made writing difficult, Euler's productivity actually increased to around 500 pages per year! Euler was a virtual Mozart of mathematics. He seemed to have unlimited creativity.

The first person who attempted to move beyond the calculator to the computer was **Charles Babbage** (1791–1871). Babbage studied mathematics at Cambridge and became the Lucasian Professor in 1828. Babbage made numerous contributions including founding the Royal Statistical Society around 1833. Babbage wanted to make accurate mathematical tables which, to that point, had been produced by hand calculation, a process prone to error.

TURN TO THE EXPERTS FOR **SUBSCRIPTION** CONSULTANCY

Subscribe is one of the leading companies in Europe when it comes to innovation and business development within subscription businesses.

We innovate new subscription business models or improve existing ones. We do business reviews of existing subscription businesses and we develop acquisition and retention strategies.

Learn more at [linkedin.com/company/subscribe](https://www.linkedin.com/company/subscribe) or contact
Managing Director Morten Suhr Hansen at mha@subscribe.dk

SUBSCR✓**BE** - to the future



Babbage designed a *Difference Engine* in 1821 to calculate polynomial functions. Since polynomials can be used to approximate trigonometric and logarithmic functions, the difference engine would be able to produce these as well. The difference engine was basically a very advanced calculator and not a true computer. However, the concept was established that advanced calculation could be done mechanically, not by hand, and produce better results. (See Link 17.11.)

Link 17.11 Babbage's Difference Engine

<http://ed-thelen.org/bab/bab-t-photo.jpg>

Babbage built parts for his device but never completed it. However, in 1853, using Babbage's design, two Swedish engineers built the first difference engine. Ever improved models were produced by the Swedes and used to calculate mathematical tables. (To celebrate Babbage's bicentennial in 1991, the difference engine that Babbage designed was built. Both the difference engine and its printer worked as designed.)

Babbage realized that his design was limited because it required human intervention and in 1834 designed an *Analytical Engine* which was a true mechanical computer. The computer would accept instructions and data from cards with holes punched in them and also produce answers on punched-cards. The concept came from the Jacquard loom which was invented in 1801. (See Link 17.12.)

Link 17.12 Babbage's Analytical Engine

http://www.sciencemuseum.org.uk/images/object_images/535x535/10303274.jpg

Again, Babbage could not obtain sufficient funds to build his computer but he had created, at least in concept, the first programmable computer complete with memory and processor, data and instruction input and output. Lady Ada, a mathematician, communicated regularly with Babbage. She wrote plans for various uses of the computer and her plan to compute Bernoulli numbers is considered the first computer program. Babbage worked on the design of the analytical engine until his death.

17.3 Boolean Algebra

Charles Babbage's life spanned that of **George Boole** (1815–1864) who became the single most important mathematician, if not the most important individual, in the development of the digital computer.

Before we discuss Boole, we need to differentiate between *analog* and *digital* computers. In general, *digital* means using numbers whereas *analog* means using some physical variable. (Digital devices are discrete while analog devices are continuous.) Your automobile speedometer is an analog computer because it uses the voltage generated by a magnetic pickup on the wheel of your car to move a pointer on an electric gauge on your dash board to indicate the speed. On the other hand, a baseball catcher uses a digital device (a hand with fingers) to send signals to the pitcher. (One finger means fastball and two means curveball.) Analog signals are usually about 1% accurate and, with great difficulty, can be 0.1% or even better. But, digital signals can be made more accurate by adding more digits, virtually without limit.

In the first half of the 20th century there was considerable development of electronic analog computers. There are circuits that easily solve differential equations, the steady diet of certain kinds of engineering, and analog computers can be built to simulate such things as a chemical manufacturing process. Fluid analog computers have been used in rocket control and other applications. However, digital computers can provide virtually unlimited accuracy and so science depends upon digital computers for accurate calculations. (See Link 17.13.)

Link 17.13 Analog Computer

<http://www.osnews.com/img/4101/chm4.jpg>

George Boole was the opposite in life from Charles Babbage. His father was working class and there was no chance for Boole to obtain a quality education. However, Boole's father loved mathematics and taught everything he knew to George who quickly surpassed him. A family friend taught George Latin and he became fluent in German, Italian and French as well. He studied the *Principia* and the work of the great French mathematicians Laplace and Lagrange.

By 1840 the self-taught Boole was publishing original mathematics. He received a medal from the Royal Society in 1844 and in 1847 published his seminal paper, *The Mathematical Analysis of Logic*, which founded Boolean algebra or symbolic logic. Boole claimed that logic was really a field of mathematics, not philosophy as it had been considered since Aristotle invented it. Because of this work Boole was appointed to the faculty of Ireland's Queen College. Boole continued to publish until his untimely death at 49.

Boole turned Aristotle's formal logic into a mathematical form where symbols could be manipulated. By representing TRUE as 1 and FALSE as 0, the operations AND, OR, and NOT, could be performed mathematically. However, this requires new sets of rules.

For the AND operator:

$1 + 1 = 1$	TRUE AND TRUE = TRUE
$1 + 0 = 0$	TRUE AND FALSE = FALSE
$0 + 1 = 0$	FALSE AND TRUE = FALSE
$0 + 0 = 0$	FALSE AND FALSE = FALSE

But, for the OR operator:

$1 + 1 = 1$	TRUE OR TRUE = TRUE
$1 + 0 = 1$	TRUE OR FALSE = TRUE
$0 + 1 = 1$	FALSE OR TRUE = TRUE
$0 + 0 = 0$	FALSE OR FALSE = FALSE

In the binary system (base 2) numbers are represented as a string of 1's and 0's. The following table shows how decimal numbers (base 10) can be represented as binary numbers. (See Table 17.1.)

What do you want to do?

No matter what you want out of your future career, an employer with a broad range of operations in a load of countries will always be the ticket. Working within the Volvo Group means more than 100,000 friends and colleagues in more than 185 countries all over the world. We offer graduates great career opportunities – check out the Career section at our web site www.volvogroup.com. We look forward to getting to know you!

VOLVO
 AB Volvo (publ)
www.volvogroup.com

VOLVO TRUCKS | RENAULT TRUCKS | MACK TRUCKS | VOLVO BUSES | VOLVO CONSTRUCTION EQUIPMENT | VOLVO PENTA | VOLVO AERO | VOLVO IT
 VOLVO FINANCIAL SERVICES | VOLVO 3P | VOLVO POWERTRAIN | VOLVO PARTS | VOLVO TECHNOLOGY | VOLVO LOGISTICS | BUSINESS AREA ASIA



Decimal	Binary
0	0
1	1
2	10
3	11
4	100
5	101
6	110
7	111
8	1000
9	1001
10	1010
11	1011
12	1100
13	1101
etc.	

Table 17.1 Binary Representation of Decimal Numbers

The last binary number in the table, 1101, represents:

$$1 \times 2^3 + 1 \times 2^2 + 0 \times 2^1 + 1 \times 2^0 = 8 + 4 + 0 + 1 = 13$$

Two binary numbers can be added, in fact, more simply than decimal numbers. If both are 0, then the sum is 0; if one is 1 and the other 0, then the sum is 1; and, if both are 1 then the sum is 0 but a 1 is carried to the left. (i.e. $0 + 0 = 0$; $1 + 0 = 1$; $0 + 1 = 1$; and $1 + 1 = 10$.)

<u>Binary</u>	<u>Decimal</u>
0101	5
+ 0100	+ 4
1001	9

Obviously, if we can add then we can subtract, multiply, and divide. Logical expressions can be written that are the equivalent of the basic mathematical operations. This means that numbers can be converted to binary, have mathematical operations performed and the result reconverted into decimal.

17.4 Systems of Mathematics

Georg Cantor developed Set Theory in 1847 based on Boolean algebra. Set theory provides another mathematical tool that is useful in both theory and experimentation. During the late 19th and early 20th centuries, mathematicians made progress on defining formal systems of mathematics with the goal of finding a system that is complete. By complete, we mean a system of mathematics that can solve all problems, prove all true theorems and disprove all false theorems.

One individual we need to introduce is **Kurt Gödel** (1906–1978) because he eliminated the possibility that any system of mathematics could be complete. Gödel was Austrian but spent the last years of his life at the Advanced Institute at Princeton. (Einstein was also a member of the institute and they were friends.)

Gödel’s major contribution was his Incompleteness Theorem (1931) that proved there could never be a complete set of mathematics. Gödel proved that in any system there would be theorems that were true but could never be proven and theorems that were false but could never be disproven. An easy example of the Incompleteness Theorem to understand is called *The Liar’s Paradox*. If someone said to you: “I am lying.” would you believe them?

17.5 Computing Machines

Claude Shannon (1916–2001), an American mathematician and electrical engineer, completed the step from pure mathematics to practical computing in his masters’ thesis, *A Symbolic Analysis of Relay and Switching Circuits* at MIT in 1937. He was only 21 when he showed that electronic switching circuits could perform logical operations. Shannon brought Faraday and Boole together making the modern digital computer possible. (See Figure 17.14.)

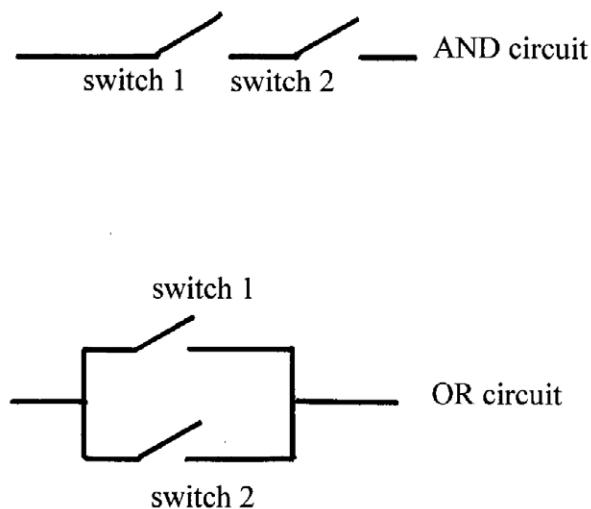

Figure 17.14 Switching Circuits for AND and OR

In the AND circuit two switches are in serial order. Thus, the circuit is complete only when both switches are closed. If we assign *True* to a closed switch, *False* to an open switch, *True* to a current flowing through the circuit and *False* to no current, then this circuit will give True when both Switches are True, and False at all other times. In the OR circuit, the two switches are connected in parallel. Now the current flows (True response) whenever one or both of the switches are closed (True) and only gives a False response when both the switches are open (False).

In 1940 Shannon completed his PhD at MIT and became a fellow at the Advanced Institute and worked on problems related to WW II. Later he joined Bell Laboratories and in 1956 became a chaired professor at MIT. Among his accomplishments was the invention of *Information Theory*. Information Theory relates to the quantification of information and applies to a wide range of fields such as communications, species diversity in biology, and statistical thermodynamics.

Shannon wrote a computer program to play chess in 1948 and he built an electronic mouse that would search through a maze and, once finding the correct path, could complete the maze from any starting position.

Alan Turing (1912–1954) was born in London and attended Cambridge where he graduated in 1934 with a distinguished degree. In 1936, he published a landmark paper on computing that defined a machine that would be capable of solving any conceivable mathematical problem for which an algorithm could be written. Such a computer, now called a *Turing Machine*, would have internal states; internal operations, an infinitely long tape; and a read/write head.

Turing was an excellent long-distance runner and completed a marathon in 2 hours and 48 minutes only 11 minutes worse than the 1948 Olympic winner and 20.5 minutes longer than the record at that time. (The record at the writing of this book is 2 hours 3 minutes and 59 seconds.) Turing did not compete in the Olympics because of an injury.

Turing continued his education at Princeton and received his Ph.D. in mathematics in 1938. During WWII, he worked on the English effort in cryptography and helped break the German Enigma Code. Turing built an electromechanical machine that speeded up the breaking of coded message. (See Link 17.15.) Breaking the German code gave the British and Americans the ability to know where the German U-boats (submarines) would be stationed and greatly reduced our loss of ships resupplying England.

Link 17.15 Enigma: German Code Machine

<http://bit.ly/1cZwoMc>

During the war, Turing also worked in the U.S. at Bell Laboratories on the development of secure speech devices. Back in England he designed a portable machine for secure voice communications. For his contributions to the war effort Turing was made an *Officer in The Most Excellent Order of the British Empire*.

After the war, Turing worked at the National Physical Laboratory on the design of the Automatic Computing Engine. In 1948 Turing was appointed to the Mathematics Department at the University of Manchester where he founded the *artificial intelligence movement*, claiming the computer could rival the human brain. Turing worked on artificial intelligence and mathematical biology for the rest of his life. In 1950 he published a seminal paper in artificial intelligence, *Computing Machinery and Intelligence*.

Turing was a homosexual and lived a tragic life in England where homosexuality was still against the law. He was burglarized, and when the police investigated, they learned of his homosexuality. He was charged and convicted. He was given a choice of going to prison or undergoing an intense estrogen therapy. (Also, his security clearance was removed.) He chose the estrogen therapy that had severe side-effects, including depression. In 1954 Alan Turing committed suicide.

Just as the revolutionary extremes of the French caused the father of modern chemistry, Antoine Laurent Lavoisier, to be guillotined; the Victorian attitude of the English caused the father of modern computer science, Alan Mathison Turing, to take cyanide.

gaieteye
Challenge the way we run

EXPERIENCE THE POWER OF FULL ENGAGEMENT...

**RUN FASTER.
RUN LONGER..
RUN EASIER...**

READ MORE & PRE-ORDER TODAY
WWW.GAITEYE.COM

The advertisement features a runner in a red top and black leggings on a dirt path at sunrise. Technical diagrams, including a dotted line and a circular diagram with lines, are overlaid on the runner's path. A yellow button with a hand cursor icon is positioned at the bottom right of the ad.

Norbert Wiener (1894–1964), an American scientist, published *Cybernetics or Control and Communication in the Animal and the Machine* in 1948. Wiener developed the theory of regulation and signal transmission applied to technical devices, living beings and even societies. His ground-breaking work continues to find many applications in our cybernetic world.

John von Neumann (1903–1957) was born in Budapest, Hungary, to a wealthy family. He was a prodigy, showing incredible aptitude in mathematics and doing graduate level mathematics by the age of 12. He completed both a Ph.D. in mathematics and a diploma in chemical engineering in 1926. Von Neumann's work in quantum mechanics was very important. He also made contributions to mathematics (including set theory), computer science, and economics. Von Neumann's *Theory of Games and Economic Behavior* (1944, with Oskar Morgenstern) founded the field of *Game Theory*.

In 1930 Von Neumann became one of the first four faculty members at the Advanced Institute at Princeton. (Einstein and Gödel were also in this group.) Von Neumann remained in the U.S. and became a citizen in 1937. He participated in the Manhattan project and helped design the atomic bomb. (It is possible that the brain cancer that killed him in 1957 was induced by his observation of the test of the atomic bomb at Trinity Site on July 16, 1945.)

Von Neumann's greatest contribution to the development of computers was designing a flexible architecture so that both instructions and data could be stored. Up to this time, computers were programmed by setting external switches. In a paper in 1945 von Neumann proposed a new design in which a single storage area would contain both the instructions for performing the calculation and data. The von Neumann architecture is the basic design for all modern computers. (See Link 17.16.)

Link 17.16 Von Neumann Architecture

<http://www.cs.cmu.edu/~ref/pgss/lecture/11/vonNeumannArch.gif>

Von Neumann was able to contribute both to the theoretical and the practical. He was very interested in the human brain and was working on understanding how it processed data and solved problems when he died. His last book, *The Computer and the Brain* (1958) is still exciting to read. Von Neumann had been invited to deliver the Sillman Lectures at Yale in 1956. He had prepared his lectures but was too ill to go to Yale. *The Computer and the Brain* was assembled from his lecture notes by his wife, Klara von Neumann.

18 The Conservation Movement and Ecology (1900–)

American settlers had a frontier world-view during the 19th century. The West was a place of opportunity. The frontier ethic stressed individual hard work and responsibility.

In the Code of Moses, God had given humanity *dominion* over nature. The Native Americans were not *using* the land. Americans were *taming* the land from coast to coast.

However, as North America became more settled some Americans began to worry about exhausting nature's storehouse. Early advocates of conservation included: Henry David Thoreau, Ralph Waldo Emerson, George Catlin, and Horace Greeley. Among the most famous conservationists were **John Muir** (1838–1914) and **Theodore Roosevelt** (1858–1919).

18.1 National Parks

In 1872, the first national park, Yellowstone National Park was established in parts of Wyoming, Montana, and Idaho. In 1892, John Muir founded the Sierra Club in San Francisco. The Sierra Club continues today as an environmental organization with hundreds of thousands of members across the United States and an affiliate group in Canada. John Muir had been instrumental in the establishment of Yosemite National Park in 1890. (See Link 18.1.)

Link 18.1 Yosemite National Park

<http://bit.ly/17IFCFB>

In 1902 congress passed the Reclamation Act which promoted irrigation and water reclamation in the west where rainfall was inadequate. By 1907, an independent bureau within the Department of the Interior was created to manage the projects.

In 1903, under the Theodore Roosevelt administration, the first national wildlife refuge was established at Pelican Island, Florida. In 1905 the U.S. Forest Service was created and the Audubon Society founded. From 1912 through 1916 the National Park System was created.

President Theodore Roosevelt's term in office (1901–1909) has been called America's *Golden Age of Conservation*. Roosevelt set aside millions of acres of forest preserves and transferred administration from the Department of Interior to the Department of Agriculture. He appointed his friend **Gifford Pinchot** (1865–1946) head of the U.S. Forest Service. Pinchot's philosophy was the "greatest good for the greatest number for the long run."⁶¹

18.2 Preservationists vs. Wise-Use Advocates

While Muir and Roosevelt were both leading figures in the environmental movement, their environmental philosophies were different. Muir was the leader of the group called *Preservationists* while Roosevelt was the nominal head of the *Wise-Use* advocates.

Preservationists, like Muir argued that large tracts of public land should remain untouched for future generations. The Wise-Use faction, led by Roosevelt, believed that government should protect public lands from harm through scientific and efficient management that promoted sustainable yield and multiple-use. Wise-Use was well-stated by Pinchot: "The first great fact about conservation is that it stands for development."⁶² And, "the art of producing from the forest whatever it can yield for the service of man." These statements, which incorporate the progressive faith in scientific management, does not move significantly away from the Mosaic Code that declares humans as stewards of nature and her resources.

In 1901, San Francisco mayor James D. Phelan and Gifford Pinchot proposed damming the Tuolumne River that ran through dramatic and pristine Hetch Hetchy Valley adjacent to Yosemite National Park. San Francisco needed drinking water. John Muir, formally a close friend of Roosevelt and Pinchot, thought damming Hetch Hetchy was nothing short of environmental sacrilege. A bitter battle lasted 12 years before the dam was finally built and the valley flooded. Even today, Preservationists continue to press to have the dam removed.

When Muir died in 1914, the leadership of the Preservationists passed to **Aldo Leopold** (1887–1948) who believed that humans should try to protect nature, not conquer it. In 1949, Leopold published *A Sand County Almanac*, a classic in environmental literature. This book and Rachel Carson's *Silent Spring* (1962) are the two most influential books of the post-war environmental movement.

In a unique way, Leopold began his essay about his farm in Wisconsin's Sand County region with a fascinating historical metaphor, cutting up an old tree blown down in a storm. As he places the saw on the tree, Leopold reflects that he first cuts through recent history as represented by the rings of the tree. Quickly, he cuts through to his college years, then past his youth to the year of his birth.

As Leopold saws on – past wet years and dry years, past fire, flood, lightning and storm – the tree’s biography is revealed by each cut of the saw. Leopold reflects that the stories he sees unfolding as he saws through the tree tell not only about the tree, but also the tree’s relationship and interaction with the environment in which it lived. Sometimes dramatically, other times most subtly, Leopold finds evidence of disease and pests during the Great Depression, of deer who had rubbed antlers against the tree during years of Prohibition, of woodpeckers who had gleaned ants during World War I, of farmers who had strung fencing when Teddy Roosevelt was president, of lovers who had left their mark during the Gay Nineties, of Indians who had camped beside the tree during the Civil War. Of course, eventually, Leopold cuts through to the pith of the tree – the center of history, so to speak – and as he does so his saw begins to cut back towards the present. (See Link 18.2.)

Link 18.2 Illustration of Tree Rings

http://www.nsf.gov/news/mmg/media/images/tree_rings_h.jpg

Leopold’s book is a delightful read but also reflects an interesting reverse picture of history which begins from the present and works its way to the past. Conventional academic history’s approach, of course, begins in the past and works its way towards the present. What would it be like to study the history of science beginning with today and working your way back to Aristotle?

In 1935, Leopold and Robert Marshall of the U.S. Forest Service founded the Wilderness Society. According to Leopold, America needed to develop a new ethic that recognized that we are part of, not independent from, natural processes. Leopold called for an ethic which not only guides our relationships towards fellow human beings, but also defines our ethical relationships with frogs and ponds, grasses and soil, birds and the air.

Imagine trying to tell a farmer that he should treat his dirt ethically. Imagine suggesting to an inner city denizen that she has an ethical responsibility for the weeds and worms in the neighboring vacant lot. Certainly, Leopold’s idea, carried to the extreme, is unworkable.

In the last year of Leopold’s life, 1948, the U.S. suffered an environmental disaster. Donora, Pennsylvania is 30 miles southeast of Pittsburgh in the lovely Monongahela Valley with hills rising on all sides – the perfect topography for a weather condition known as thermal inversion. Normally, higher air is cooler and denser providing a mechanism for mixing the air. (The heavier, cold air falls down through the lighter, warm air causing a general mixing.) However, in an inversion, the higher air is warmer and there is no mixing. The air can become stagnant and stay in the same area for days or even longer. (See Link 18.3.)

Link 18.3 Donora, Pennsylvania

http://www.pollutionissues.com/images/paz_01_img0071.jpg

Between October 26 and 31 in 1948, a prolonged thermal inversion trapped pollutants from steel mills, a zinc smelter, a sulfuric acid plant, and other industrial plants in the Donora area. Almost half of the town's 14,000 inhabitants fell ill and 20 died from breathing the polluted air. The incident raised questions about whether belching smokestacks were an unambiguous sign of economic progress.

18.3 Food Chains and Ecology

Rachel Carson (1907–1964) began her career as a biologist working for the U.S. Bureau of Fisheries. Her specialty was marine biology and oceanography. A prolific writer on the oceans and environmental topics, in 1949 (the same year Leopold published *A Sand County Almanac*), Carson became editor-in-chief of the Bureau's publications.

In 1951, she published *The Sea Around Us*, a popular natural history of the oceans which highlighted the harm that humans were doing to the seas. *The Sea Around Us*, which won Carson the National Book Award, was on the best-seller list for 86 weeks, sold more than 2 million copies, and was translated into 32 languages. It made her independently wealthy.

In the 1950s Americans became increasingly aware of air-borne pollutants. Population was growing and industry increasing in the post-war boom. Smog became a national joke, as well as a worry. Radioactive fallout from atmospheric nuclear weapon tests by the U.S. Russia, Britain, and France was a major concern about public health and safety.

This e-book
is made with
SetaPDF



SETASIGN

PDF components for PHP developers

www.setasign.com



But most people were oblivious to the threat of pesticides. In fact, DDT (dichloro-diphenyl-trichloroethane), discovered during World War II, was regarded as a miracle chemical. DDT, which helped conquer malaria by killing mosquitoes, had made fighting in the jungles of the Pacific Islands and Southeast Asia much safer for American troops. After the war, Americans launched another offensive against insects that destroyed crops and trees and transmitted disease. Farmers, foresters, city and recreational managers sprayed and sprayed. An entire industry of aerial spraying developed. The farmers' dream of killing all the destructive insects seemed to be coming true. (See Link 18.4.)

Link 18.4 DDT

<http://en.wikipedia.org/wiki/DDT>

DDT is an excellent pesticide but it is long-lived and exposure causes neurological effects in humans. DDT was banned for use in the United States in 1972, but continues to be used in parts of the 3rd world.

In the Spring of 1958, Olga Huckins, who lived in Cape Cod, Massachusetts, watched impassively as a small plane sprayed to control mosquitoes near her home and private bird sanctuary. The following day, Huckins witnessed the agonizing death of several birds in her sanctuary. Huckins wrote her friend Rachel Carson to inquire about the effects of pesticides on birds and other wildlife.

Carson discovered that there were almost no independent, analytical studies on the environmental effects of DDT or other pesticides. During the 1950s the AEC (Atomic Energy Commission) had funded pioneering research on plant metabolism using radio-active tracers. This research had conclusively established the pathways and mechanisms of numerous food chains, which in turn helped to define biological communities. In addition, the AEC had sponsored radio-active tracer research that also outlined several *food webs* and provided raw data for ecosystem theory. The AEC was interested in following the pathway through the environment of radio-active fallout from weapons testing. Carson realized that the same methodology could be used to assess the environmental impact of pesticides.

In 1962, Carson published her findings in *Silent Spring*, a warning that continued use of DDT would soon silence the woods and meadows of New England and the rest of America. Sternly, she warned: "For the first time in the history of the world, every human being is now subjected to dangerous chemicals, from the moment of conception until death."⁶³ Already, Americans had been told that in their bones they would carry to the grave radioactive strontium from atmospheric weapon tests. Carson predicted an even darker fate if pesticide spraying were continued. (Strontium is chemically very similar to calcium and finds its way into the bone structure. A major radioactive product of nuclear explosions is ⁹⁰Sr which has a half-life of 28.8 years and emits β^- particles.)

Carson's book was enormously popular with the public, and read by numerous scientists, politicians, and policy makers. Shamefully, the chemical industry mobilized to counter the threat of her book. Some reviewers noted that *Silent Spring* was more a popular book than a scientific treatise. Others contended the book was full of inaccuracies, made selective use of scientific findings, and failed to give a balanced account of the benefits of DDT.

Still others alleged that as a woman she could not understand highly technical science; or that she was hysterical; or she was a radical nature-lover trying to panic America into buying her books.

Among environmentalists, Rachel Carson became a hero, saint, and martyr. Through the intense controversy over *Silent Spring* she suffered from terminal cancer, while defending her research and answering her critics. Carson died eighteen months after publishing *Silent Spring* from metastasized breast cancer.

Ten years later (1972) Congress re-wrote the Federal Insecticide, Fungicide, and Rodenticide Act (FIFRA) of 1947 authorizing the Environmental Protection Agency to evaluate, regulate, and restrict the use of all commercial pesticides.

Scientifically, the significance of Carson's influence is the fact that the public, politicians, and policy makers have accepted the general idea of Ecosystems, that organisms at the top of the food chain, such as eagles and humans, can be profoundly affected by chemical events taking place much farther down the food chain. This acceptance, if not understanding, of ecosystem theory has caused a profound change in the way Americans understand their relationship to nature.

19 Modern Geology (1900–)

19.1 The Age of the Earth

The discovery of radioactivity provided the foundation for finally making an accurate determination of the age of the Earth. Ernest Rutherford had discovered in 1907 that radioactive elements had characteristic half-lives. He quickly understood that this could be used for dating materials by measuring the relative amounts of parent daughter combinations to see how many half-lives of decay had occurred. Later, with the discovery of isotopes, this process would become much more accurate.

Radioactive decay follows a reverse geometric progression. During the period of a half-life, one-half of a radioactive isotope decays. During the next half-life one-half of the remaining one-half decays so only one-fourth is left. And so forth. (See Link 19.1.)

Free eBook on Learning & Development

By the Chief Learning Officer of McKinsey

[Download Now](#)

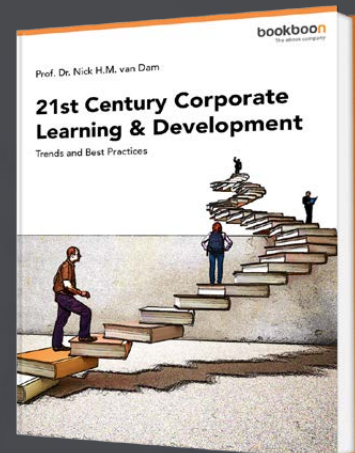

[Click on the ad to read more](#)

Link 19.1 Radioactive Decay

<http://bit.ly/1734I3M>

If you plot the logarithm of the amount remaining against time, a straight line is produced.

Link 19.2 Radioactive Decay – Logarithmic

<http://bit.ly/18MFDJK>

For this discussion, it is useful to know that naturally occurring uranium has two principle isotopes, ^{238}U and ^{235}U , that have half-lives of 4.468×10^9 years and 7.038×10^8 years, respectively. Each of these radioisotopes decays through a series of other radioisotopes with shorter half-lives and eventually becomes a stable lead isotope. ^{238}U becomes ^{206}Pb and ^{235}U becomes ^{207}Pb . (^{232}Th , with a half-life of 14.05 billion years, eventually becomes ^{208}Pb . All other known isotopes of lead are themselves radioactive.)

Since the ^{238}U isotope is more than 99% of naturally occurring uranium, measuring the uranium and lead contents of rocks gives a means of estimating the age of the rock, assuming only uranium was present at the beginning. For example, if the ratio of uranium to lead is 1, a half-life has passed and the material is 4.5 billion years old. If, however, the ratio of uranium to lead is only $\frac{1}{3}$, it means 75% has decayed (25% remains) and two half-lives have passed. (See Link 19.3.)

Link 19.3 Uranium/Lead Ratio

<http://bit.ly/18INND3>

Arthur Holmes (1890–1965) was born in Low Fell, Gateshead, England, and, after high school, enrolled in the Royal College of Science in London to study physics. He quickly became interested in geology and graduated with his bachelor's degree in 1910. Radioactivity had been discovered about 15 years earlier and its application to geochronology was already being attempted. Holmes studied for a doctorate degree but had financial problems because his scholarship paid him only about \$100 a year.

In 1911, Holmes went to Mozambique to prospect for minerals but was stricken with malaria. He became so ill a death notice was telegraphed home. However, he recovered and returning to the Royal College studied uranium-lead ratios in rocks. He concluded this radiometric method of dating rocks was more accurate than the geological sedimentation and cooling studies of the Earth.

Holmes wrote in his remarkable first book, *The Age of the Earth* – which was published in 1913, the same year he received his doctorate degree – that the Earth was at least 1.6 billion years old. This greatly extended the estimate of Kelvin and others of 10–100 million years. Holmes's estimate provided time for evolution and uniformitarianism. Holmes became a professor at the University of Durham and then later at the University of Edinburgh where he stayed until his death. By the 2nd edition of *The Age of the Earth*, Holmes was estimating the Earth to be between 1.6 and 3.0 billion years old.

In 1919 Aston invented the mass spectrometer and it became possible to separate isotopes and measure their masses and percentages accurately for the first time. Radiometric measurements continued to be improved and the chemistry of minerals was studied by Holmes and others to help verify the assumption that uranium was isolated from lead in certain minerals.

Zircon, a mineral which appears in various colors, has the chemical structure ZrSiO_4 . It is a very hard mineral that withstand heating as high as 2500°C. Uranium atoms can replace zirconium atoms in the crystal structure but lead is ejected. Since uranium but not lead could be part of the crystal when it was formed, it can be dated by measuring the uranium/lead ratio. Zircon has been used to age rocks, meteorites and other materials.

The age of the Earth is now known to be $4.54 \pm 0.05 \times 10^9$ years. The oldest meteorites studied have an age of 4.567 billion years. The moon has been dated at 4.4–4.5 billion years and Martian meteorites that have landed on Earth are around 4.5 billion years. The canyon diablo meteoritic material in the Barringer Crater (Meteor Crater) in Arizona also agrees with this date. The sun has been dated based on its mass and luminosity compared to other stars. Again the age agrees and we are forced to conclude that the sun and solar system were formed about 4.5 billion years ago.

Studies of the sun have also shown that about one-half of the sun's hydrogen has been converted to helium by nuclear fusion. This means that the sun will use up all of its hydrogen in another 5 billion years. The sun will then cool and collapse and the gravitational heating from the condensed helium will start another fusion process to produce carbon. This will raise the temperature of the sun and the planets. The helium fusion stage will last about 1 billion years and the Earth will be heated in this process and all its water will be boiled away. Finally, the sun will expand and become a red giant absorbing the planets Mercury and Venus and probably the Earth as well.

The oldest fossils that have been found are 3.5 billion years old. since we know the Earth to be 4.5 billion years old, we conclude that life began on Earth sometime within its first billion years.

19.2 Continental Drift and Plate Tectonics

Many school children who have looked at a world globe have noticed that the east coast of South America would fit nicely against the west coast of Africa. For the first half of the 20th century this was explained as a simple coincidence. But, as we will learn, there is a far more profound explanation for this observation.

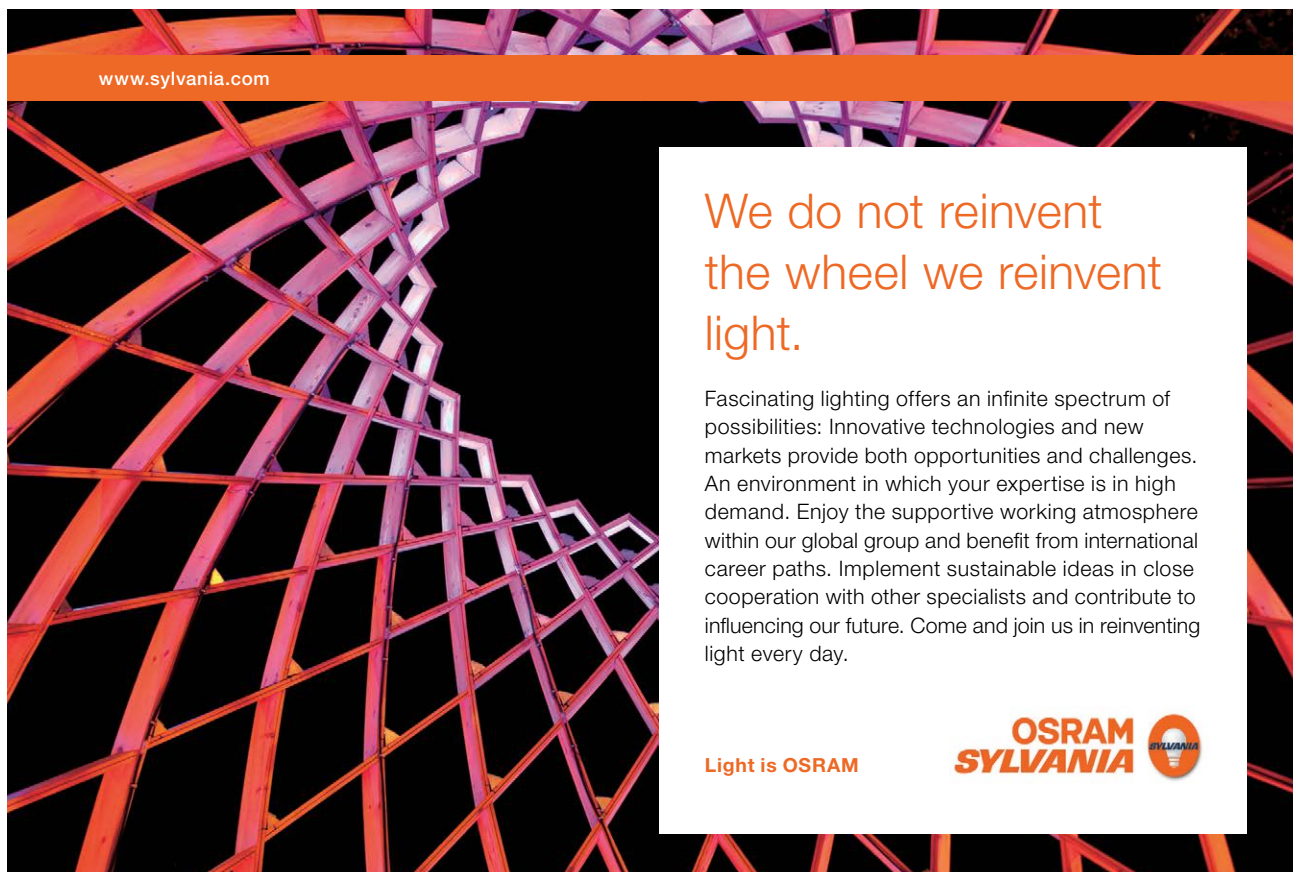

www.sylvania.com

We do not reinvent
the wheel we reinvent
light.

Fascinating lighting offers an infinite spectrum of possibilities: Innovative technologies and new markets provide both opportunities and challenges. An environment in which your expertise is in high demand. Enjoy the supportive working atmosphere within our global group and benefit from international career paths. Implement sustainable ideas in close cooperation with other specialists and contribute to influencing our future. Come and join us in reinventing light every day.

Light is OSRAM

OSRAM
SYLVANIA



Geologists divide the Earth into three principle zones and several lesser levels. (See Link 19.4) The center zone is the core and is thought to be mostly molten iron. However, the inner core may be solid. Remember that gravitational forces become very strong as you approach the center of a large object, so strong in fact if there is enough mass the temperature rises to the level necessary to initiate hydrogen fusion and a star is born. (The planet Jupiter has about 60% of the mass necessary to become a star.)

Link 19.4 Earth Zones

<http://bit.ly/1f5eKT0>

The core is around 15% of the volume of the Earth and above it is a viscous layer called the mantle which makes up about 84% of the volume of the Earth. The final 1% of the Earth is called the crust, a solid layer about 70% covered by water. The oceans hold about 96.5% of all Earth's water and are, on average, 2.65 miles deep. The deepest part of the ocean is about 6.9 miles.

Magma is molten rock that lies beneath the surface. When it comes above the surface we call it lava. (For some reason, we continue to call it lava after it cools and solidifies.) Lava flows directly into the lowest parts of the oceans.

The upper mantel (inner asthenosphere) is about 200 km (125 miles) thick and is composed of plastic, flowing rock while the rest of the mantel (lithosphere) is rigid rock. The slow movement of continents is caused by the very slow, but extremely powerful, currents in the asthenosphere.

The crust is just 5 miles thick. The magma is molten rock beneath the crust and is in three categories: granitic, which is 75–80% silica; andesitic, which is 52–63% silica; and basaltic which is 45% silica. The greater the silica content, the more viscous or rigid is the rock and the granitic rock is the hardest. The continents are granitic rock. Steam also flows out of volcanos covering the Earth with water. The water from within the Earth probably came from comets. The lava flows seen from volcanos are basaltic. When granitic rock is ejected from volcanos, it is blown out in great chunks.

Edward Suess (1831–1914) who was born in London and became a professor of geology at the University of Vienna, claimed in the late 19th century that the continents were once joined together. (See Link 19.5) In his 1885 three-volume *Das Antlitz der Erde* he claimed there had been land bridges connecting the continents into a supercontinent that he named Gondwana and that was surrounded by the Tethys Ocean. His work was based upon fossils of similar ferns that occur in South America, Africa, and India.

Link 19.5 Gondwana

<http://bit.ly/1apJUqw>

Alfred Wegener (1880–1930) was born in Berlin and studied physics, meteorology, and astronomy. He received a doctorate in astronomy from Friedrich Wilhelms University in 1905. He and his older brother invented the use of weather balloons to track air movements. He made expeditions to Greenland and continued to work as a meteorologist until joining the German army in 1914.

Wegener was wounded twice in WWI and, while recovering, studied maps that were mounted on the walls of his bedroom. He decided to cut out the continents and found that he could get about an 80-85% fit of the continents to each other.

Next Wegener made cutouts along the lines of the continental shelves instead of the coast lines. Now he found the fit above 90%, a fact that convinced him that all the continents had once been joined in the form of a single mass he called Pangea. Pangea would have been broken apart about 200 million years ago. (See Link 19.6) Wegener first published his idea of continental drift in 1922 in *The Origin of Continents and Oceans*. Most of the experts were extremely critical of the idea of continental drift and Wegener's conclusions were rejected.

Link 19.6 Pangea

<http://bit.ly/1d3R1G7>

Wegener presented his ideas again in 1926 at a symposium of the American Association of Petroleum Geologists who again rejected continental drift. In 1929 he made his third expedition to Greenland and in 1930 his fourth and last.

The last expedition was supposed to establish three permanent stations in Greenland so that scientists could spend the winter there. However, a late thaw caused Wegener and this team to get six weeks behind schedule and, running out of fuel, they sent a message that they would return. They needed to get enough supplies so that two men could spend the winter in the camp.

Wegener set out with the team by dog sled on September 24 to re-supply the western camp. The weather was too bad and most of the group turned back. Wegener continued but died en route and the Greenlander who went with him was never found. The following spring, on May 12, 1931, Wegener's body was found halfway between the two camps. His grave was marked by a pair of skis.

Criticisms of Wegener's ideas were based on the known rigidity of the granitic rock of continents. Geologists could not identify any source of energy sufficient to move a continent.

Until WWII, geologists thought that ocean bottoms were flat. Sonar had been invented shortly before 1913 and was further developed by WWII because of its ability to locate submarines. (Actually in 1490 Da Vinci inserted a tube into water and putting the other end to his ear found that he could locate ships by listening to their sounds. And, in the late 19th century, underwater bells were used in addition to light houses to warn ships of underwater hazards.)

In WWII the Atlantic Ocean was mapped and it was found that there were mountain ranges and valleys instead of a flat bottom. Post WWII geologists continued this mapping and found mountain ranges in every ocean. Volcanos were found and in the Pacific Ocean a deep sea trench. Other ocean trenches were found and they were always parallel to the cost line and parallel to mountain ranges on land. (See Link 19.7.)



Discover the truth at www.deloitte.ca/careers

Deloitte.

© Deloitte & Touche LLP and affiliated entities.



Click on the ad to read more

Link 19.7 Ocean Trenches

<http://bit.ly/14hEZUJ>

For example, there is a trench off the coast of the states of Oregon and Washington aligned with the Cascade mountain range and another off the coast of Peru and Chile aligned with the Andes mountain range. There is another trench (the Marianas Trench) off the east coast of Honshu, the main island of Japan. (See Link 19.8) This is the deepest trench on Earth and is almost 7 miles below sea level.

Link 19.8 Marianas Trench

<http://bit.ly/169dQPX>

Oceanic mountain ranges are called ridges. Using a magnetometer, a device that shows the direction of magnetic fields, Fred Vine (1939–) and Drummond Matthews (1931–1997) showed that magnetic bands on each sides of oceanic ridges are reversed and the bands are mirror images. (See Link 19.9) This reversal of magnetic bands showed that the ocean bottom was moving away from a ridge, i.e. the ridge had been pushed up from bottom. So new ocean is being made at the ridges and disappearing into the trenches. (See Link 19.10)

Link 19.9 Ocean Ridge

<http://bit.ly/1bRdfbk>

Link 19.10 Ocean Ridges and Trenches

<http://bit.ly/19HUNo5>

Arthur Holmes had supported Wegener's theory of continental drift. In his *Principles of Physical Geology*, published in 1944, Holmes proposed there were convection cells in the Earth caused by heat from the Earth's core. (See Link 19.11)

Link 19.11 Convection Cells

<http://bit.ly/1d3Recd>

In 1960, an American Harry Hess (1906–1969), who was a geologist and U.S. Navy officer, put together one of the key supports of Holmes's, and hence, Wegener's theory. The United States had built 250 seismic stations to watch for Soviet underground nuclear tests. These stations showed a layer between 100 miles and 250 miles below the crust (the asthenosphere) that was plastic so rocks could flow. Hess, in a report to the Office of Naval Research, proposed that plates on which continents sit are moving away from the oceanic ridges. Each plate is typically bounded on one side by a ridge and on the other by a zone of subduction where the edge of one plate is moving beneath another. (See Link 19.12) This is how continents can collide! A dramatic example is the highest mountain range on Earth, the Himalayas, which were created by the collision of a plate broken off Africa with the Asian subcontinent. (See Link 19.13)

Link 19.12 Continental Drift and Plate Movement

<http://go.grolier.com/atlas?id=mtlr093&tn=/atlas/printerfriendly.html>

Link 19.13 Formation of the Himalayas

<http://bit.ly/16JeIB0>

The theory of plate tectonics was finally accepted in 1965, some 35 years after Wegener's death and half a century after Wegener had cut out pieces of maps and fitted them together.

SIMPLY CLEVER

ŠKODA



We will turn your CV into an opportunity of a lifetime



Do you like cars? Would you like to be a part of a successful brand? We will appreciate and reward both your enthusiasm and talent. Send us your CV. You will be surprised where it can take you.

Send us your CV on www.employerforlife.com



Click on the ad to read more

20 Afterword

What can we say about the future of modern science? We have discussed the developments and breakthroughs that brought science to its present state. And, we have presented details of many individuals whose imagination, and sometimes just plain luck, carried science to new levels. Will we continue to see in the 21st century the kind of remarkable advancement that has characterized the roughly four centuries of modern science? Prediction is always dangerous, especially in writing. Nothing can date a book about science faster than prediction. And yet, the temptation is irresistible.

Would we have predicted at the time of the death of Galileo (1642) that in only 25 years mathematics would be discovered that could describe accurately all the experiments with mechanics that Galileo attempted? When Galvani thought he had discovered animals were the source of electricity (late 1700s), would we have expected that the next century would see the elucidation of electricity and magnetism and that light would be characterized as an electro-magnetic wave?

In 1900 science was in turmoil because the discovery of the electron, radioactivity and x-rays seemed to be destroying Newtonian physics. But, little did the scientists of that time know that this crisis would result in a new physics, this one based on quantum mechanics and relativity.

But what of the 21st century? Will it take us to yet another level of science, to theories and phenomenon of which we don't yet even suspect? Some scholars claim science is coming to an end, that it has gone as far as it can in explaining the universe and all that remains is working out the details. But remember Diderot who thought that the 18th century was approaching the end of knowledge. He predicted there would not be three great geometers (mathematicians) in 100 years.

Some believe today that little is left to be discovered. But, I disagree. I think the confusion in certain areas of science today speaks of another great awakening. Perhaps there will be another Newton or Einstein. We are, after all, about due. I am sure that we have many interesting discoveries yet to make and, unfortunately, those discoveries will continue to be as dangerous as they are useful. (Bernoulli's equations made flying possible and the airplane was used in war barely a decade after the Wright Brother's first flight.)

I think one frontier of science may be the social sciences. Neurobiology is moving closer to psychology and statistical mechanics is starting to simulate population dynamics. Clearly the world needs social systems, both political and economic, that work better. Malthus was right, the disaster of unlimited population growth is still in front of us. The 20th century was the bloodiest in history and the 21st is not off to a great start. We have to develop new ethics for the global society and new ways to provide basic necessities everywhere.

In the classical sciences, there is much yet to be understood and I believe the next 50 to 100 years will add greatly to our already vast understanding. In biology, as we have already mentioned, the neurosciences are moving rapidly with the help of magnetic resonance imaging and large scale computer modeling. Understanding consciousness is the key to understanding humanness. Genomics is telling us more and more about the evolutionary ladder, what we are, and how we might advance our own abilities.

Geology will achieve fuller understanding of world-wide phenomena. Crises (such as global warming) and what to do about them will only be solved through study of the Earth (geo-logy). Chemistry will design molecular machines and perhaps be the avenue by which we achieve quantum computing. Quantum computing offers unimaginable capabilities to analyze and study data and systems.

Physics will hopefully see the reconciliation of quantum mechanics and relativity. Perhaps string theory will be the solution. But, however this is accomplished, it could possibly set the stage for the long sought *Theory of Everything*. Cosmology must, and I think will, reconcile the various theories of the creation of the universe and give us the answer to this ultimate question.

There will be incredible practical uses of this new science. Consider the great problems that face us: energy, clean water, health care, human rights. Many of these problems are a matter of inadequate resources. Where resources are insufficient, the strong tend to take from the weak, and human rights are forgotten. Fusion power could provide virtually unlimited energy to the world and problems like water purification and transportation would be quickly solved.

Most of all, advanced, inexpensive communication would mean people could stay where they were: to work, to learn, to be healed. Many of our problems arise from the fact that, to have an advanced society with an advanced economy, people must be moved from place to place, regularly and rapidly. If we could work, study and play in a virtual world, many of these issues would go away.

It is tempting to say of science that we've only just begun. But, I don't think that is true, I believe we have built a solid foundation and will continue to climb but will never reach the level that we think Galileo, Faraday and Darwin were unimportant. And, I believe we will reach a new level of education and sophistication in dealing with science.

The easy problems have been solved. We have moved on to the hard ones and, if we are to have the full advantage of scientific knowledge, then we must have a society that understands science and can apply it properly. I think one of the greatest frontiers of science must be science education, and not just elementary school, high school, or college education, but continuous education for our entire population. How else will we ever know the innovators from the hucksters? In the future, I hope everyone will be able to know the difference.

Finally, in the Preface I promised to address the reason I used the word *Evolution* in the title to describe the development of modern science, rather than *Foundation, Beginning, Advent*, or some other possibility. In *The Essential Darwin*, Kenneth Korey explains that Darwin's Law of Evolution has three requirements: Exponential growth; variation; and inheritance.⁶⁴

Since the 17th century, which saw the likes of Galileo, Descartes, and Newton, scientists and scientific investigation has grown at an exponential pace. Explanations of phenomena, such as evolution, have seen the varied ideas of Lamarck, Darwin, and Agassiz. Scientific societies, through publication, correspondence, and meetings, have guaranteed the inheritance of facts and ideas from one generation to the next.

The evolution in the way we think about the world may be science's greatest contribution. Modern science began with curiosity and skepticism, and it will mark, more than any other event, the passing of human beings through history. If you doubt this, draw up your own list of the 100 most important people in history. Notice how many of them are scientists!

Watch and participate in the ongoing Evolution of Modern Science. Come on in, the water's fine.

Thomas L. Isenhour
Norfolk, VA USA



The advertisement features a central image of a smiling teacher leaning over a laptop to assist two young children, a boy and a girl. To the right, there are two smaller circular inset images: one showing three children looking at a book together, and another showing children working at computer desks in a classroom. The background is a vibrant yellow and orange swirl design.

e-learning for kids

- The number 1 MOOC for Primary Education
- Free Digital Learning for Children 5-12
- 15 Million Children Reached

About e-Learning for Kids Established in 2004, e-Learning for Kids is a global nonprofit foundation dedicated to fun and free learning on the Internet for children ages 5 - 12 with courses in math, science, language arts, computers, health and environmental skills. Since 2005, more than 15 million children in over 190 countries have benefitted from eLessons provided by EFK! An all-volunteer staff consists of education and e-learning experts and business professionals from around the world committed to making difference. eLearning for Kids is actively seeking funding, volunteers, sponsors and courseware developers; get involved! For more information, please visit www.e-learningforkids.org.

21 Appendices

21.1 Appendix 1 – Arithmetic and Geometry

The Greek origin of arithmetic is a combination of the verb *arithmein*, to count, and *tekhne*, an art. Thus, arithmetic (Latin to French to Old English) is *the art of counting*. From counting we easily get the ideas of addition and subtraction. They are just extensions of counting. And from addition and subtraction we get multiplication and division. Multiplication is just a series of additions and division a series of subtractions.

The Ancient Greeks did more with numbers than just counting. They developed number theory which is the study of integers. For example, they knew about prime numbers, those are numbers like 7, 19, and 43 that can only be divided by themselves or by 1. Euclid himself proved that there are an infinite number of prime numbers. (This is an elegant and sophisticated proof.)

Classical geometry is basically constructive. That means that geometric figures may be drawn and used to construct other figures within a set of known geometric proofs. Geometry finds great application in engineering.

Euclid (ca 330–275 B.C.) systematized geometry in his 13 Volume *Elements of Geometry* that dominated western mathematics for 1000 years. Euclid's *Elements* remains one of the greatest mathematical works of all time. Elements or Paracelsus's principles. Boyle was a faithful Newtonian. Euclid introduced two abstract concepts, the Definition and the axiom. An axiom is a self-evident statement. For example, a circle inscribed in a square will always have an area less than that of the square. (See Figure A.1.) It is obvious that no matter what size square we make, a circle inscribed in that square will have an area that is only part of the area of the square.

Euclid showed how to develop geometry from a series of points, straight lines, definitions, and axioms. (Unfortunately, Euclidean geometry leads away from the idea of zero or negative numbers. For example, can you imagine a circle with a negative radius? The absence of zero and negative numbers in the mathematics of the west greatly retarded the advance of science.)

Elements of Geometry starts with 23 definitions, five postulates and five common notions. Here are the famous five postulates:

1. It is possible to draw a straight line from any point to another point. (Two points define a straight line.)
2. It is possible to produce a finite straight line continuously in a straight line. (A straight line contains an infinite number of points.)

3. It is possible to describe a circle with any center and radius.
4. All right angles are equal.
5. If a straight line falling on two straight lines make the interior angles on the same side less than two right angles, the straight lines meet on the side on which the angles are less than two right angles line. (Parallel lines never meet.)

In Euclidian geometry, we prove theorems by constructive methods. (The origin of the word is Greek: *Ge* means Earth and *metro* means measure. Geometry is measuring the Earth.) An example is a carpenter's method for cutting the end of a board at a 45-degree angle. A carpenter will lay a nail across the end of the board and then use his finger to mark the same length down one edge of the board. He then draws a line from the other edge of the board to the point marked on the edge. The result is a right triangle formed by the side and end of the board and the line. Since the side meets the end of the board at a right angle and the two legs are the same length, their angles must be equal and, hence, 45 degrees. (See Figure A.2.)

Greeks multiplied by constructive methods. To multiply two numbers you make them the sides of a rectangle – the area of the rectangle is the product. To multiply three numbers use a cube. The volume of the cube is the product of the three numbers.

The Pythagorean theorem was known in various parts of the world well before Pythagoras. (For any right triangle, $h^2 = a^2 + b^2$, where h is the hypotenuse and a and b are the sides. The Mesopotamians had the relationship around 1800–1900 BCE.) The Pythagoreans were a secret Greek society that developed a great deal of arithmetic and geometry. Among their discoveries were irrational numbers. (Numbers that cannot be represented by the ratio of two integers. Such numbers, like π and $\sqrt{2}$ have an unending string of digits.)

Archimedes (287–212 BCE) estimated π (the ratio of the circumference of circle to the diameter) as described in Chapter II. Archimedes, who was probably the first mathematical physicist, said: “Give me a lever long enough, and I shall move the Earth.” He clearly understood the idea of mechanical advantage, all that is involved in levers and pulleys.

Archimedes integrated irregular areas by inscribing triangles. Doing so, he was on the verge of discovering calculus. But, of great limitation was the fact that the Greeks did not have algebra.

There is a certain chicken and egg problem in the relation being mathematics and science. Nothing in Archimedes time required calculus but when, in Newton's time, the development of physics required calculus, it was invented. Some say the need for calculus caused it's invention.

The scientific paradigm of 1700 years between Archimedes and Newton prevented, in my opinion, the developmental use of algebra and later calculus. As we study Aristotle, you will see why I draw this conclusion. Basically, negative numbers and infinities are necessary for algebra and calculus. Aristotle opposed these concepts for religious reasons.

21.2 Appendix 2 – Formal Logic

Thales of Miletus (ca 624–546 BCE) is credited with the invention of philosophy. Thales refused help from gods, spirits, ghosts or any other agents unacceptable to a rational mind. Thales attitude may have been the origin of the conflict of science and religion.

Aristotle (ca 384–322 BCE) invented formal logic which is based upon premises and conclusions and uses Truth Tables to determine the validity of conclusions. For example, we might say the following: “If I have enough money and it snows, I will go skiing.” Our premises are: A (I have enough money) and B (it snows). Our conclusion is: C (I will go skiing).

The logical construction of this argument is: $(A \text{ AND } B) \rightarrow C$

A Truth Table can list all possibilities:

<u>A</u>	<u>B</u>	<u>C</u>
T	T	T

Cynthia | AXA Graduate



AXA Global Graduate Program

Find out more and apply

redefining / standards 



T	F	F
F	T	F
F	F	F

With the *AND* operation only one set of conditions (both premises being True) leads to a True conclusion. The *OR* operation can be inclusive or exclusive. The *inclusive OR* (OR) is True when either or both premises is True. The *exclusive OR* (XOR) is True when either but not both of the premises is True. “NOT” is the final operator which reverses the premise.

Aristotle also gave us the *sylogism* in which a major premise and a minor premise lead to a conclusion. (Sometimes this is stated as two premises leading to a conclusion.) In logic this is expressed as: If $A \rightarrow B$ and $B \rightarrow C$ then $A \rightarrow C$, where “ \rightarrow ” means “implies.” For example:

All mammals have hair (major premise)

Marmots are mammals (minor premise)

Marmots have hair (conclusion)

“All mammals have hair” AND “Marmots are mammals” \rightarrow “Marmots have hair.”

(Do not make the mistake of making the minor premise “Marmots have hair” and then concluding “Marmots are mammals.” The major premise, “All mammals have hair” is not exclusive because there could be non-mammals that have hair.)

Electronic computers are easily constructed for binary operations and binary codes consisting of 0’s and 1’s can be used to represent TRUE and FALSE. (e.g. a switch can be either on or off, a spot on a magnetic tape can be magnetized as a north pole or south pole, etc.) Because formal logic expressions can be written to perform arithmetic operations such as addition and subtraction, digital computers operate in binary. We will discuss this concept further when we discuss Boolean Algebra in Appendix 7.

21.3 Appendix 3 – Algebra

Zero was invented in different civilizations. Zero was used as a place marker in numbering systems. (For example: 2, 20 and 200 or 83 and 803. In each of these cases the 0 is used to determine whether, as in the first example, the 2 refers to 2 ones, 2 tens, or 2 hundreds.)

Around 900 BCE, India had a symbol for zero. The Babylonians invented a number system but had no zero, and the Mayans had zero around 100 CE. Hindus adopted zero to their mathematics about 500 years later and the Arabs, who invented algebra, around the 8th century.

Zero was brought to Europeans around 1000 CE and Fibonacci introduced the zero to European mathematics in 1202 AD. Aristotle's idea that zero was impossible had held mathematics back. But consider how difficult it is to calculate without a number system. Following is a comparison of multiplication in our base 10 system to multiplication in Roman numerals:

<u>Decimal Numerals</u>	<u>Roman Numerals</u>
1 x 25 = 25	I x XXV = XXV
2 x 15 = 50	II x XXV = L
3 x 25 = 75	III x XXV = LXXV
4 x 15 = 100	IV x XXV = C
or	
2 x 5 = 10	II x V = X
20 x 5 = 100	XX x V = C
200 x 5 = 1000	XXX x V = M
20 x 50 = 1000	XX x L = M

There are no rules for arithmetic in Roman Numerals. How would you add II and II and get IV? (And, if you think addition or multiplication would be difficult, consider long division!) Quantitative science is virtually impossible without a number system. Quantitative commerce is also very difficult and that means that banking is can only be local, not international

But, with a number system you need only learn the multiplication table of the basic digits. For example, in the decimal system, we only need to learn from 1×1 through 9×9 to be able to multiply all possible combinations of numbers.

The Greeks did use formulas for calculation. e.g. $h^2 = a^2 + b^2$ But they did not discover the rules for manipulating variables to get new relationships.

In algebra we move from the formula to the equation. An equation can represent numbers by symbols and we can manipulate the symbols to get new relationships. Consider a circle with radius (r) equal to 5 centimeters. ($r = 5\text{cm.}$) From the formula for the area (A) of a circle, $A = \pi r^2$, can calculate the Area to be 78.5 cm^2 . ($A = 3.14 \times [5 \text{ cm}]^2 = 78.5 \text{ cm}^2$.)

If we wanted a square of the same area, we could calculate the side (s) of such a square by $s = \sqrt{A} = \sqrt{(78.5 \text{ cm}^2)} = 8.86 \text{ cm}$.

But if we treat the two formulas (formulae) as equations, we can determine the relationship of side of a square to the radius of circle that would have the same area.

$$A_{\text{cir}} = \pi r^2 \text{ and } A_{\text{sq}} = s^2$$

$$A_{\text{cir}} = A_{\text{sq}}$$

$$\pi r^2 = s^2$$

and $s = r\sqrt{\pi}$

Now we have derived a general relationship between the ratio of a circle and the side of a square that have the same area, no matter what that area is. Applying it to the case above we can calculate the side without reference to the actual area by: $s = r\sqrt{\pi} = 5 \text{ cm} \times \sqrt{(3.14)} = 8.86 \text{ cm}$. Diophantus (ca 200–284 CE), a Greek mathematician in Alexandria, wrote the first treatise on algebra (*Arithmetica*) and created such equations but dismissed all those that gave negative numbers as solutions.

Around 830 CE, Al-Khowarizmi, a Persian scientist and mathematician, wrote *Al-Jabr Wa'l Muqabalah*, and gave methods for solving all equations of first and second degree with positive roots. (“Al-Jabr” translated from Arabic means “from science.”) Al-Khowarizmi’s algebra allows the manipulation of symbols to derive new relationships.

The great Persian Poet, astronomer and mathematician, Omar Khayyam solved cubic equations about 1100 using geometric methods, an important step towards unifying geometry and algebra. Khayyam pointed out that algebra is not just a collection of tricks for obtaining an answer but a science deeply related to geometry. (Descartes finally unified algebra and geometry with his invention of analytical geometry, which is the subject of Appendix 4.)

I joined MITAS because
I wanted **real responsibility**

The Graduate Programme
for Engineers and Geoscientists
www.discovermitas.com



Real work
International opportunities
Three work placements



Month 16
I was a construction
supervisor in
the North Sea
advising and
helping foremen
solve problems



Causality, the relationship between events, is the most fundamental concept in science. Causality is well expressed by the general equation of algebra, $y = f(x)$, y is a function of x . Notice the importance of the word *function* in the previous sentence. This equation is not just saying that y can be calculated from x but that y behaves according to x . The very idea that the universe is ordered and can be understood, the bedrock of science, is embodied in this concept.

Modern science, which begins about the end of the Renaissance, **is a search for functional** relationships. When we write Newton's law of gravity: $F = m_1 m_2 / r^2$, we are saying that the force of gravity between two objects is the product of the masses of the objects divided by their distance squared. And, we know from this equation how that force changes with changes in mass or distance. We can, accordingly, determine the orbit of a satellite or trajectory of a baseball. It is the manipulation of the symbols that allows algebra to both generalize known information and discover new knowledge. For example, if we have an equation for the movement of a spacecraft away from Earth as a function of time, Newton's Law of Gravity can be combined with that equation to give the force of gravity on the spacecraft as a function of time.

Remember Zeno's paradox of a race between Achilles and a Tortoise. Because the Tortoise is slower, we give her a head start. Even though we know Achilles is very swift, whenever he runs to the position of the Tortoise, the Tortoise will have moved away, however little. Zeno uses this idea to claim that Achilles can never catch the Tortoise. Let's see how Algebra would deal with this race.

Let the starting point of the race = 0 km; let Achilles run 25 km/hr; let the Tortoise run 5 km/hr (Turbo Tortoise); and let the Tortoise have a 10 km head start. The equations are:

$$D_A = 0 + 25T$$

$$D_T = 10 + 5T$$

where D_A is the distance of Achilles from the starting point; D_T is the distance of the Tortoise; and T is the total time of the race.

Achilles will catch the Tortoise when they are in the same position, that is, when $D_T = D_A$. Let's call this time T_c .

$$D_A = 0 + 25T_c \text{ and } D_T = 10 + 5T_c$$

$$D_A = D_T \text{ and } 0 + 25T_c = 10 + 5T_c$$

$$25T_c - 5T_c = 10$$

$$20T_c = 10$$

$$T_c = 10/20 = 1/2 \text{ hour or 30 minutes.}$$

Thus Algebra disagrees with Zeno's paradox and actually tells us the time when Achilles catches the Tortoise.

Algebra can carry this even farther and generalize the equation for the starting points of the Tortoise and Achilles ($S_T - S_A$) and the rates at which each of them run ($R_a - R_T$). The time that Achilles will catch the Tortoise will be $T_c = (S_T - S_A)/(R_a - R_T)$.

Notice that as long as the Tortoise has a head start, ($S_T > S_A$), and Achilles runs faster ($R_a > R_T$), Achilles will catch the Tortoise, ($T_c > 0$), that is, T_c will be positive. But, if Achilles is slower than the Tortoise, ($R_a < R_T$), then T_c will be negative, a result that is not physically meaningful. You can play with this equation and find some other interesting results.

Here is another problem the answer to which seems obvious, but the obvious is often wrong. Algebra will come to the rescue. Assume the Earth is exactly 25,000 miles around at the equator. A little mouse, who is 1 inch high, lives on the south side of the equator but crosses to the north side every morning to eat breakfast. A cable is made that is 25,000 miles and 1 foot long. The cable is suspended uniformly in a circle directly over the equator. Of course, the cable does not touch the Earth. Does the little mouse have to climb over the cable or can he walk under it? Intuitively, it would seem that the mouse must climb over the cable. Let's see.

$$C_E = \pi D = 25,000 \text{ miles}$$

where C = Circumference of Earth and D is diameter of Earth

$$C_c = \pi (D + 2H) = 25,000 \text{ miles} + X$$

H is height of cable over the Earth and X is additional length of cable

Subtracting the first equation from the second we have:

$$2H\pi = X$$

$$H = X/2\pi$$

For $X = 12$ inches, $H = 1.91$ inches. The mouse walks under the cable!

21.4 Appendix 4 – Analytical Geometry

There is a story that Descartes was sitting at a table watching a fly and realized that he could locate the fly if he knew its distance from the floor and two of the adjacent walls. Today we refer to Cartesian coordinates when we use the X-Y-Z coordinates in three-dimensional space or use the conventional X-Y coordinates to describe objects in two-dimensional space. (See Figure A.3.) (Each coordinate is at right angles (orthogonal) to the others. For certain applications it is useful to talk about n dimensions in an n -dimensional hyperspace in which case each of the n dimensions would be perpendicular to all of the others.)

It is now possible to solve Galileo's relativity problem and many other problems by redefining coordinate systems. If forces are described as vectors, the vectors may be added algebraically to find the resultant vector. For example, a cannon ball moves as a result of momentum and acceleration by gravity. Adding the constant forward movement vector to the continuously changing downward movement vector will give the equation for a parabola which correctly describes the path of the cannon ball.

Stability of an object sitting on the surface of the Earth is defined by whether movement causes the center of mass to move towards or away from center of Earth. A body in a perfect circular orbit is continuously falling towards the attracting body but never comes closer to the attracting body. (See Figure A.4.) Thus if we slow down the satellite it falls to a lower orbit which becomes elliptical. If we accelerate the satellite it moves to a higher, elliptical orbit. Notice, when a space shuttle wants to return to Earth, it points its rockets in the direction of its orbit and fires them, thereby losing speed so that it falls towards the Earth.

The invention of analytical geometry clearly set the stage for the invention of calculus.

Figure A.5 shows a graph of the race between Achilles and the Tortoise. Using the data from Appendix 3 above, both of their positions are plotted versus time. Because the lines cross, it is shown that Achilles must catch the Tortoise.

Figure A.6 gives a proof of the Pythagorean Theorem using analytical geometry.

ie business school

93%
OF MIM STUDENTS ARE
WORKING IN THEIR SECTOR 3 MONTHS
FOLLOWING GRADUATION

MASTER IN MANAGEMENT

- STUDY IN THE CENTER OF MADRID AND TAKE ADVANTAGE OF THE UNIQUE OPPORTUNITIES THAT THE CAPITAL OF SPAIN OFFERS
- PROPEL YOUR EDUCATION BY EARNING A DOUBLE DEGREE THAT BEST SUITS YOUR PROFESSIONAL GOALS
- STUDY A SEMESTER ABROAD AND BECOME A GLOBAL CITIZEN WITH THE BEYOND BORDERS EXPERIENCE

Length: 10 MONTHS
Av. Experience: 1 YEAR
Language: ENGLISH / SPANISH
Format: FULL-TIME
Intakes: SEPT / FEB

5 SPECIALIZATIONS
PERSONALIZE YOUR PROGRAM

#10 WORLDWIDE
MASTER IN MANAGEMENT
FINANCIAL TIMES

55 NATIONALITIES
IN CLASS

www.ie.edu/master-management | mim.admissions@ie.edu | [f](#) [t](#) [i](#) Follow us on IE MIM Experience

21.5 Appendix 5 – Calculus

$Y = f(x)$; y is a function of x is the essence of basic algebra. Symbol manipulation, associated with arithmetic, unleashes the power to describe phenomena, to reference and relate one phenomenon to another. Mathematically, the syllogism was our first method of combining information to derive new information. With algebra, it becomes possible to construct proofs, formulas and equations and manipulate them to make new discoveries much the same way that grammar allows us to combine words into sentences and sentences into essays.

Infinity, even as introduced by so simple a concept as Zeno's Paradoxes, poses a major challenge to mathematics. How can we deal with functions when values approach infinity, or in some cases, when they approach zero? (See Figure A.7.) This figure shows graphically the behavior of some functions as they approach a limit.

However, for many functions, we cannot determine algebraically how they will behave at a limit. This is the problem that Calculus solves for Algebra. Calculus is, in many ways, is easier to think about than algebra. In a sense, calculus is just algebra carried to the limit of Zeno's infinite series and infinitesimal steps.

Consider a straight line: $y = f(x) = mx + b$ where m and b are constants, called, respectively, the slope and the intercept. In our algebraic treatment of Zeno, the speed of the tortoise was the slope (m) and the starting point in the race was the intercept(b).

For any line, straight or otherwise, we can approximate the slope over an interval as: $\Delta y/\Delta x$. For example, as you drive your car along the highway, the speedometer indicates the momentary speed. You can calculate the average speed by dividing a distance by the time it takes. If we travel 60 miles in one hour, our average speed is 60 miles per hour. Likewise, if we travel 30 miles in one-half an hour, our average speed is 60 miles per hour. The speedometer might range from 45 to 70 during the trip so the average is only approximately correct at any given moment. As we shorten the time interval, the calculated slope becomes closer to the instantaneous slope.

The exact slope at any point would be: $dy/dx = \lim_{\Delta x \rightarrow 0} \Delta y/\Delta x$

The limit of $\Delta y/\Delta x$, as we make the x interval shorter and shorter and finally zero, is called the derivative, dy/dx . Differential calculus is a method of finding these limits (or derivatives).

Consider the straight line, $y = mx + b$. We know that the limit, that is the slope, must be m at all times. But, let's see how we would arrive at this by calculus.

$$\Delta y = (y + \Delta y) - y = m(x + \Delta x) + b - (mx + b) = mx + m\Delta x + b - mx - b = m\Delta x$$

$$\frac{dy}{dx} = \lim_{\Delta x \rightarrow 0} \frac{\Delta y}{\Delta x} = \lim_{\Delta x \rightarrow 0} \frac{m\Delta x}{\Delta x} = \lim_{\Delta x \rightarrow 0} (\frac{\Delta x}{\Delta x})m = \lim_{\Delta x \rightarrow 0} m = m$$

While the above solution is trivial, since we already knew the answer, it is instructive. We can use this same *delta method* on functions that are not linear and do not have obvious solutions.

Consider the parabola that a cannon ball describes. Algebraically this is described as:

$y = ax^2 + bx + c$ where x is the distance the ball has traveled and y is its height above the ground.

The slope is continuously changed. At first, dy/dx is positive and the cannon ball is rising above the Earth. But, gravity decreases the ball's upward velocity eventually stopping the climb and for an instant the slope (change of height with distance) is zero. Then, the slope becomes more and more negative as the ball falls ever more rapidly to the Earth.

From the equation above, we can calculate the height, y , at any distance, x . We can also estimate the slope over any interval by calculating two different y 's for two different x 's and computing the ratio to give $\Delta y/\Delta x$. But from algebra, we cannot calculate the slope at an instantaneous value of x because $\Delta x = 0$. Nor can we calculate at what x the ball will be highest nor what that height will be. We can, however, determine all of these using calculus.

First we need to determine dy/dx for any x by taking the limit of $\Delta y/\Delta x$ as $\Delta x \rightarrow 0$. We use the same trick as above to accomplish this.

$$\Delta y/\Delta x = \{(y + \Delta y) - y\}/\Delta x$$

We use the function: $y = f(x) = ax^2 + bx + c$ and solve for $y + \Delta y$ and y .

$$\begin{aligned} y + \Delta y &= f(x + \Delta x) = a(x + \Delta x)^2 + b(x + \Delta x) + c = ax^2 + 2ax\Delta x + a(\Delta x)^2 \\ &+ bx + b\Delta x + c \\ y &= ax^2 + bx + c \end{aligned}$$

$$\begin{aligned} \text{Then } y + \Delta y - y &= ax^2 + 2ax\Delta x + a(\Delta x)^2 + bx + b\Delta x + c - ax^2 - bx - c \\ y + \Delta y - y &= 2ax\Delta x + a(\Delta x)^2 + b\Delta x \end{aligned}$$

$$\begin{aligned} \text{Next } \Delta y/\Delta x &= \{(y + \Delta y) - y\}/\Delta x = \{2ax\Delta x + b\Delta x + a(\Delta x)^2\}/\Delta x \\ \Delta y/\Delta x &= 2ax + b + a\Delta x \end{aligned}$$

$$\begin{aligned} \text{Finally } dy/dx &= \lim_{\Delta x \rightarrow 0} \Delta y/\Delta x = 2ax + b \\ \Delta x &\rightarrow 0 \end{aligned}$$

Now we can, using calculus, calculate the slope (dy/dx) at any value of x ; the slope is just $2ax + b$. And, we can calculate the value of y at any point, as we always have because $y = ax^2 + bx + c$. Finally, we want to know the values of x and y when the cannon ball is at its maximum height. We will call these x_{\max} and y_{\max} . This is easy to determine because the maximum height will occur at the x position when the slope is zero, that is, when the cannon ball's upward motion has been stopped by gravity, and $dy/dx = 0$.

$$\begin{aligned} \text{at } y_{\max}, \quad dy/dx &= 2ax_{\max} + b = 0 \\ \text{and } x_{\max} &= -b/2a \end{aligned}$$

Finally, this value of x_{\max} , $-b/2a$, can be used to calculate y_{\max} .

$$\begin{aligned} y_{\max} &= ax_{\max}^2 + bx_{\max} + c \\ y_{\max} &= a(-b/2a)^2 + b(-b/2a) + c \\ y_{\max} &= a(b^2/4a^2) - b^2/2a + c \\ y_{\max} &= b^2/4a - b^2/2a + c \\ y_{\max} &= b^2/4a - 2b^2/4a + c \\ y_{\max} &= -b^2/4a + c \end{aligned}$$

In summary, we started out with an analytical equation for a parabola: $y = ax^2 + bx + c$. We then differentiated this equation to produce the differential equation: $dy/dx = 2ax + b$

In calculus, if we can differentiate, as we've done by the delta method, we can integrate. This is important because in many situations in nature, we can write the differential equation but not the analytical function that it represents. For example, when Newton realized that acceleration is constant, that is the rate of change of a falling object is constant (g) then he could write the equation: $V = gt$, where V = velocity, t = time, and g is a constant.

But V (velocity) = dy/dt . That is, velocity is the change of position, y , with time. So we write the differential equation: $dy/dt = gt$. It is beyond the scope of this presentation to show how we do it, but we can integrate this equation and get $y = 1/2gt^2$. (You can apply the delta method of differentiation and show that you get the original differential equation back.) The result of this equation (constant acceleration) is that the distance an object falls is proportional to the square of the time it falls.

Now that we can use calculus to do simple differentiation, we are finally in a position to show the flaw in Zeno's logic. Let's deal with the form of Zeno's paradox about walking across the room. Zeno would have us divide the path into smaller and smaller steps until we are taking infinitely small steps, each of which, of course, takes an infinitely short time. To get across the room, therefore, we must make infinite number of infinitesimal steps. (Remember Euclid's second proposition: a line has an infinite number of points. Hence one must conclude that each point is of infinitesimal size.)

Define the distance across the room as X , and the size of each step as ΔX .

To cross the room in one step: $\Delta X = X$ and $1 \times \Delta X = X$.

To cross the room in two steps: $\Delta X = X/2$ and $2 \times \Delta X = 2 \times X/2 = X$.

To cross the room in three steps: $\Delta X = X/3$ and $3 \times \Delta X = 3 \times X/3 = X$.

To cross the room in n steps: $\Delta X = X/n$ and $n \times \Delta X = n \times X/n = X$.

Zeno challenges us by making the steps smaller and smaller until they become infinitesimal. We must answer the question of what is the value of $n\Delta X$ at the limit when $\Delta X \rightarrow 0$? (Note: as $\Delta X \rightarrow 0$, $n \rightarrow \infty$.)

$$\lim_{\Delta X \rightarrow 0} n\Delta X = \lim_{\Delta X \rightarrow 0} \{n(X/n)\} = \lim_{\Delta X \rightarrow 0} \{(n/n)X\} = \lim_{\Delta X \rightarrow 0} X = X$$

Notice, the key is that $n/n = 1$, no matter how large n becomes. The limit of (n/n) as $\Delta X \rightarrow 0$ (or $n \rightarrow \infty$) is 1.

Given the marvelous tool of calculus that he invented, Newton was able to calculate such things as orbits by showing what the curvature of the path of an object like the Moon becomes as it constantly changes direction due to the Earth's gravitational field. While calculus can become very complex, just like music and literature, it still relies upon these fundamental methods of dealing with problems that generate infinities and zeros that cannot be treated by conventional algebraic or geometric methods.

"I studied English for 16 years but...
...I finally learned to speak it in just six lessons"
Jane, Chinese architect

ENGLISH OUT THERE

Click to hear me talking before and after my unique course download

21.6 Appendix 6 – Statistics

Statistics can be used for analyzing noisy data. For example, if you had several people measure your height in centimeters (cm), you might get results like this: 176, 178, 177, 176, 179, 177, 177, 174, 175, 175 cm. (1 inch = 2.54 cm. You are about 5 feet 10 inches tall.) How would you determine the correct, or at least best, answer?

Statistics developed out of probability theory. The mathematics of the 17th and 18th century laid the foundation for modern statistics. Let's treat the problem above in a standard way. If we assume, and this assumption is very important, that the difference in the numbers is caused by random errors, we can analyze the distribution of results. The binomial theorem tells us the results of a large number of random errors having equal probability of increasing or decreasing the true value. The following curve shows the binomial distribution. (See Figure below.)

http://www.comfsm.fm/~dleeling/statistics/normal_curve.gif

In this figure, μ is the mean (or average) value, and σ is the standard deviation. If we call x_i the i^{th} of n values, then $\mu = \Sigma x_i/n$ and $\sigma = \sqrt{[\Sigma(x_i - \mu)^2/(n-1)]}$. In this case, $\mu = 176.4$ cm and $\sigma = 1.5$ cm. From the figure, we can see that 68.2% of the results will lie between $\mu - \sigma$ and $\mu + \sigma$. This means that we have a 68.2% confidence that the answer is in the range 176.4 ± 1.5 . Further, we can have a 95.4% confidence that the answers lie in the range 176.4 ± 3.0 and a confidence of 99.7% that the answer lies in the range 176.4 ± 4.5 . But we can never have 100% confidence!

The binomial distribution is often called a normal, or Gaussian, distribution. However, there are subtle differences between the binomial and Gaussian distributions.

There are several important issues to consider in using statistical interpretation of data. One is that there are distributions other than the binomial distribution. This becomes particularly important in dealing with subatomic phenomena. Most distributions, however, give similar error values and, when dealing with social science data, the distribution choice is not very important, so usually use the binomial distribution because of its simplicity.

In using statistical analysis there are two other important issues. The first assumption is that the error is random. There are also systematic errors which simple statistics cannot detect. For example, suppose the tape measure used by everyone to measure your height was not accurate. No amount of statistical analysis can deal with this kind of systematic error. If the tape measure was supposed to be 100 cm long and it was actually only 90 cm long, every measure would be too large and so would be the mean.

The second assumption is that random sampling has taken place. For example, in taking polling data, it is assumed that a random sample of the population has been measured. It is necessary to do independent, complex analysis to guarantee the randomness of sampling. Simply surveying the students in this class would not be an accurate measurement of the students at this university. The students at the class were available at this time, needed or wanted to take this class, etc. That would not be true of the student body in general.

While statistical analysis is the main stay of many areas of social science research, particularly psychometrics, it is also important in physical and biological science. Epidemiology, statistical mechanics, and other areas depend extensively on the mathematics of probability and statistics.

21.7 Appendix 7 – Boolean Algebra and Set Theory

In the 19th century, an English mathematician, George Boole, invented an algebraic form of logic. Boole's seminal publication was *Mathematical Analysis of Logic* (1847) which founded Boolean algebra or symbolic logic. Until this time, Aristotle's formal logic was considered a branch of philosophy. Boole showed that it could also be represented mathematically.

Boole found a way to turn Aristotle's formal logic into a mathematical form where the symbols could be manipulated.

If 1 = True and 0 = False, then we have logical operations such as $A \cap B$, where \cap represents the logical operator AND. Boolean operations then become:

Boolean Operator	Logic Equivalent
$1 + 1 = 1$	True AND True = True
$1 + 0 = 0$	True AND False = False
$0 + 1 = 0$	False AND True = False
$0 + 0 = 0$	False AND False = False

Digital switching devices are easily designed to perform all Boolean functions. Hence with Boolean algebra it becomes very convenient to do logic.

All numbers can be represented the base 2 (binary) number system. For example, 1101 is binary for 13. ($1 \times 2^3 + 1 \times 2^2 + 0 \times 2^1 + 1 \times 2^0$ or $8 + 4 + 0 + 1 = 13$.) Using Boolean algebra is it easy to design a mechanical way to perform addition, subtraction, multiplication and division of binary numbers. Binary numbers are much more easily represented in mechanical and electronic systems than the numbers to the base 10 that we naturally use, presumably because we have ten fingers and starting counting this way.

Binary numbers can be represented by a set of circuits, each representing a power of two, which can be turned on or off. This maps directly into logical expressions by considering an *on* circuit as *true* and an *off* circuit as *false*. Simple electronic devices can be constructed to accomplish *AND*, *OR* and *NOT* logical operations. The entire computer revolution is based upon Boolean algebra.

Set theory, which is another important way to describe systems, also arises directly from Boole's work. Georg Cantor, a Russian born mathematician who moved to Germany at an early age, developed the basic relationships between objects and their memberships in sets.

Just as we have logical operators such as *AND* to determine commonness between individual objects, Set Theory has operators such as the union of two sets that determines their common members, etc. Set theory has many applications in other areas of mathematics and is also important in areas of theoretical physics and chemistry.

21.8 Appendix 8 – The Ancients Revisited – Titus Lucretius Carus

Titus Lucretius Carus, or Lucretius, as he is known, lived from about 99 BCE to about 55 BCE. He was a Roman Poet who wrote *De Rerum Natura, On the Nature of the Things*. This epic poem was written to free Romans of superstition and fear of death.

Lucretius, worried that his Roman colleagues could no longer read the Greek philosophers and scientists, translated their works into his Latin poem of six books for their edification. There are several English translations.

Out of personal interest, I have defined what I think are the 12 greatest discoveries of science. (I started out to make a list of 10 but it became too hard to eliminate the last 2 and I ended up with 12.) Then I used *On the Nature of Things* to determine what the Greeks had to say on each of these topics. Finally I scored the Greek performance rating their knowledge on each discovery as: 2 – good understanding; 1 – partial understanding; and 0 – no understanding. Here is my list of discoveries and my rating of the Greek understanding based on Lucretius.

HELIOCENTRICITY(2) – Aristarchus of Samos (ca 310 to 230 bc), a student of Aristotle, measured the relative sizes of the Sun, Moon, and Earth, worked out their masses and concluded that the Earth went around the much heavier Sun.

THE CELL(0) – Could not be discovered before invention of microscope.

MECHANICS(2) – “Give me a lever and a place to stand and I shall move the Earth.” Archimedes. (He also worked out Law of the Lever.)

NATURAL HISTORY(2) – “...it is in the highest degree unlikely that this Earth and sky is the only one to have been created and that all those particles of matter outside are accomplishing nothing. This follows from the fact that our world has been made by nature through the spontaneous and casual collision and the multifarious, accidental, random and purposeless congregation and coalescence of atoms whose suddenly formed combinations could serve on each occasion as the starting-point of substantial fabrics – Earth and sea and sky and the races of living creatures. On every ground, therefore, you must admit that there exist elsewhere other clusters of matter similar to this one which the ether clasps in ardent embrace.” Lucretius

UNIFORMITARIANISM(2) – Lucretius points out that the wind is due to un-seeable particles; the Earth is molded by wind and rain; the Earth, sun and stars are constructed from condensing atoms; the oceans, although fed by rivers do not increase in size because water is lost to the sky; he slips a little by claiming volcanoes are formed by underground winds, although I suppose you could call the fluid forces of the magma a kind of wind. At least he was sure they weren't caused by demons.

ATOMIC THEORY(2) – “Material objects are of two kinds, atoms and compounds of atoms. The atoms themselves cannot be swamped by any force for they are preserved indefinitely by their absolute solidity.” “While there are many atoms of the same kind, there are also different kinds.” “The number of different kinds of atoms is finite.” “Nature resolves everything into its component atoms and never reduces anything to nothing.”

ELECTROMAGNETISM(1) – “Sunlight moves faster in empty space than it moves through air.” “Lightning is composed of smaller atoms and can pass through other substances.” Lucretius also explains magnets attracting iron by a particle process. i.e. he had the concept of force fields which, as in quantum mechanics, requires particles. Lucretius also points out that particular incidences of light give rise to different colors.

EVOLUTION(2) – Lucretius’s Book Five is on Cosmology and Sociology. “For the nature of the world as a whole is altered by age. Everything must pass through successive phases. Nothing remains for ever what it was. Everything is on the move. Everything is transformed by nature and forced into new paths. One thing, withered by time, decays and dwindles. Another grows strong and emerges from ignominy. So the nature of the world as a whole is altered by age. The Earth passes through successive phases...” “monstrous and misshapen births were created. But all in vain. Nature debarred them from increase. They could not gain the coveted flower of maturity nor procure food nor be coupled by the arts of Venus. For it is evident that many contributory factors are essential to be able to force the chain of a species in procreation. First, it must have a food-supply. Then...”

THERMODYNAMICS(1) – “Nothing is ever created out of nothing.”

GENETICS(2) – “Seeds are required to produce plants, animals and man.” “Everything grows gradually from a specific seed and retains its specific character.” “Children you see of a two-sided likeness, combining features of both mother and father...” “...children...recall features of great-grandparents.” “...latent seeds, grouped in many combinations from an ancestral stock handed down from generation to generation.” “...evokes a random assortment of characters,...voice or hair; for these characters are determined by specific seeds...” “...the embryo is always composed of atoms from both sources, only it derives more than half from the parent it more closely resembles.”

RELATIVITY(1) – “Similarly, time by itself does not exist;...It must not be claimed that anyone can sense time by itself apart from the movement of things or their restful immobility.”

QUANTUM MECHANICS(1) – “When the atoms are traveling straight down through empty space by their own weight, at quite indeterminate times and places they swerve ever so little from their course.” “If atoms never swerve so as to snap the bonds of fate...what is the source of free will possessed by living things...?”

Summary

Discovery	Rating
HELIOCENTRICITY	2
THE CELL	0
MECHANICS	2
NATURAL HISTORY	2
UNIFORMITARIANISM	2
ATOMS & ELEMENTS	2
ELECTROMAGNETISM	1
EVOLUTION	2
THERMODYNAMICS	1
GENETICS	2
RELATIVITY	1
QUANTUM MECHANICS	1

TOTAL SCORE = 18/24 Not bad for 2200 years ago.

Thomas L. Isenhour

May 31, 2013

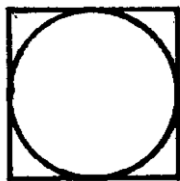

Figure A.1 Circle inscribed in square.

It is *axiomatic* that the area of a circle inscribed in a square is smaller than the area of the square.

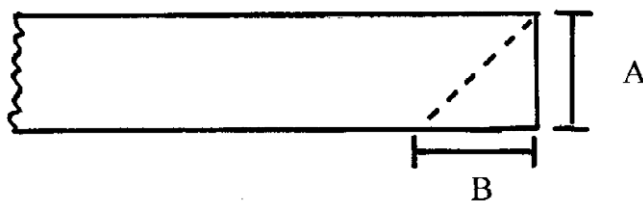
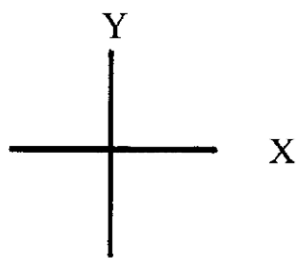
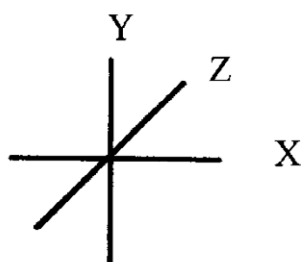

Figure A.2 Marking the end of a board at a 45-degree angle.

To mark the board and cut a 45° angle, first measure the end, A, and then measure an equal distance from the end on one side, B. Connecting from the ends of A and B gives a 45° angle. The side of the board to the end is a right angle (90°) and, since the two sides of the triangle are equal, the other two angles are also equal. A triangle has a total of 180° and that means that each of the other two angles must be $(180^\circ - 90^\circ) / 2 = 45^\circ$.



2 – dimensional (X, Y)



3 – dimensional (X, Y, Z)

Figure A.3 Two and Three-Dimensional Coordinate Systems

Each coordinate, (X and Y or X, Y, and Z), is at a right angle (90°) to each of the other coordinates. On a 2 – dimensional surface, knowing X and Y completely defines the location of a point. In 3 – dimensional space, knowing X, Y and z completely defines the location of a point.

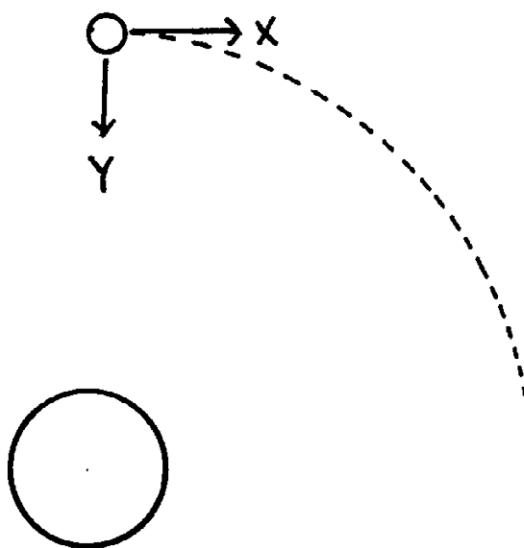

Figure A.4 Body in perfect circular orbit.

Momentum carries the body forward (X – axis) while gravity accelerates the body downward (Y – axis). The combined forces – measured as vectors – causes the body to move in an arc. If the combination is correct, the body will travel in a circle or perfect orbit.

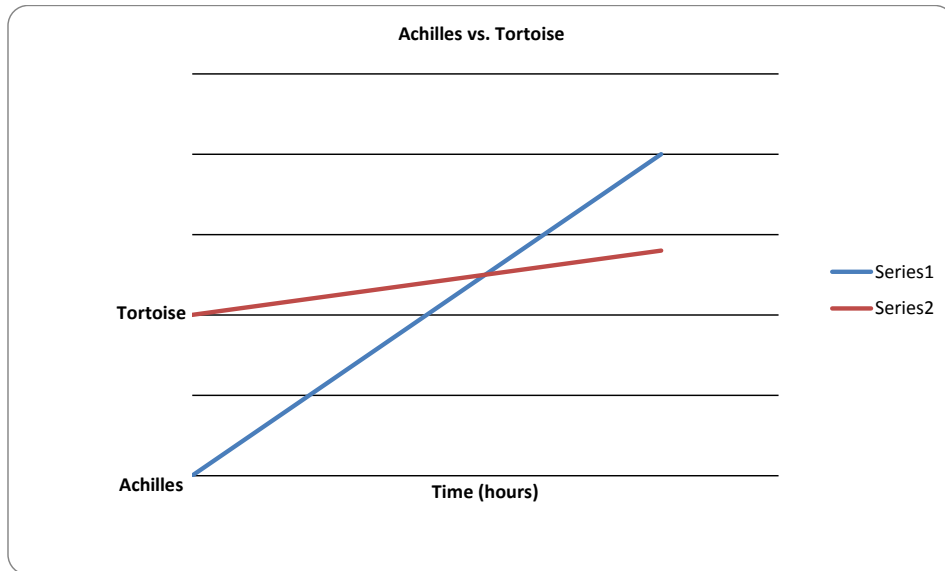

Figure A.5 Achilles racing the Tortoise.

Achilles runs at 25 km/hr and the Tortoise at 5 km/hr. The Tortoise has a 10 km head start. After 0.5 hours, they are at the same place.

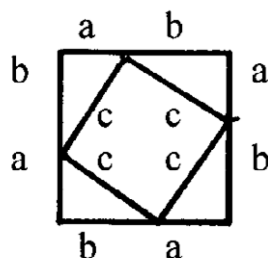

Figure A.6 Proof of Pythagorean Theorem

1. Draw Outer Square.
2. Divide each side into two unequal segments, a and b. (Therefore Side of Outer Square = a + b.)
3. Draw Inner Square from division points on each side.
4. Label internal side of Inner Square c.
5. A Right Triangle is defined by sides a, b, and c.
6. Area of the Triangle = $ab/2$.
7. Area of Outer Square = $(a + b)^2$
8. Area of Outer Square = Area of Inner Square + 4 x Area of Triangle
9. Area of Outer Square = $c^2 + 4ab/2$

Therefore:

$$10. (a + b)^2 = c^2 + 4ab/2$$

$$11. a^2 + 2ab + b^2 = c^2 + 2ab$$

$$12. a^2 + b^2 = c^2$$

$$Y = 1/(X+1)$$

as $X \rightarrow 0$, $y \rightarrow 1$

as $X \rightarrow \infty$, $Y \rightarrow 0$

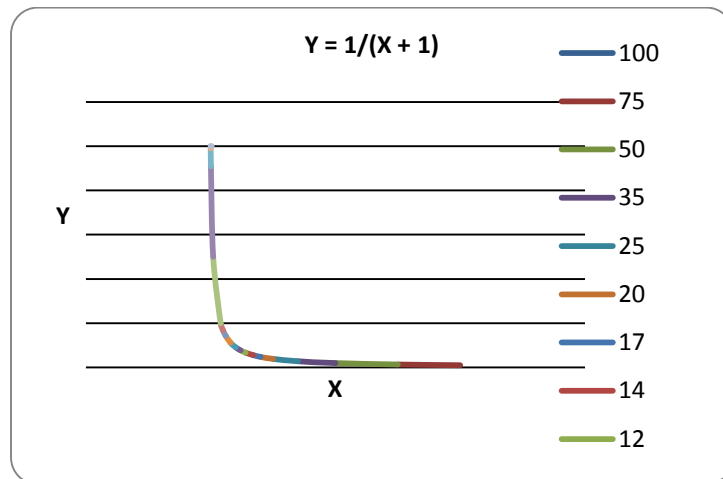
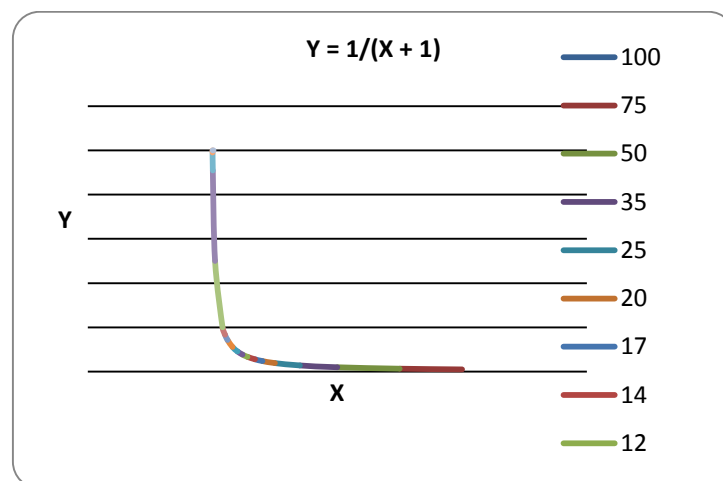

Figure A.7 Graphs of functions.

$M = M_0 / (1 - V^2/C^2)^{1/2}$
 as $V/C \rightarrow 0$, $M \rightarrow M_0$
 as $V/C \rightarrow 1$, $M \rightarrow \infty$



22 Bibliography

Alioto, Anthony M., *History of Western Science*, 2nd Ed., Prentice Hall, Englewood Cliffs, New Jersey, 1987.

Asimov, Isaac, *How Did we Find Out the Earth is Round*, Walker & Company, United States of America, 1972.

Boorstin, Daniel J., *The Discoverers*, Vintage Books, New York, 1985.

Bragg, Melvyn, *On Giant's Shoulders: Great Scientists and Their Discoveries*, John Wiley and Sons, London, 2000.

Carson, Rachel, *Silent Spring*, Houghton Mifflin, Boston, 1962.

Copernicus, Nicolaus, *On the Revolutions of Heavenly Spheres*, Prometheus Books, New York, 1995.

Darwin, Charles – Carroll, Joseph, *On the Origin of Species*, Broadview Press, Ontario, Canada, 2003.

Dobbs, Betty Jo Teeter, & Jacob, Margaret C., *Newton and the Culture of Newtonianism*, Humanities Press International, Atlantic Highlands, New Jersey, 1995.

Eves, Howard, *Great Moments in Mathematics Before 1650*, Math. Assoc. of America, United States of America, 1983.

Eves, Howard, *Great Moments in Mathematics After 1650*, Math. Assoc. of America, United States of America, 1983.

Fischer, Robert B., *Science, Man and Society*, W.B. Saunders, Philadelphia, 1971.

Galileo, *Dialogue Concerning the Two Chief World Systems*, University of California Press, Berkeley, California, 1953.

Gould, Stephen Jay, *Ever Since Darwin*, W.W. Norton & Company, New York, 1973.

Gribbin, John & Gribbin, Mary, *Richard Feynman – A Life in Science*, Penquin, New York, 1998.

Hager, Tom, *Linus Pauling*, Oxford University Press, New York, 1988.

Hal Hellman, *Great Feuds in Science: Ten of the Liveliest Debates Ever*, John Wiley and Sons, New York, 2001.

Humes, Edward, *Monkey Girl: Evolution, Education, Religion, and the Battle for America's Soul*, Harper Collins, New York, 2007.

Ifrah, Georges, *The Universal History of Computing*, John Wiley and Sons, New York, 2001.

Jaffe, Bernard, *Crucibles: The Story of Chemistry*, Dover, New York, 1930.

Jastrow, Robert, General Editor, *The Essential Darwin*, General Editor, Little Brown & Company, Canada, 1984.

Leopold, Aldo, *A Sand County Almanac*, Oxford University Press, New York, 1949.

Lucretius, *On the Nature of the Universe*, Johns Hopkins Press, London, 1995.

Lurie, Edward, *Louis Agassiz – A Life in Science*, University of Chicago Press, Chicago, 1960.

Marks, John, *SCIENCE and the Making of the Modern World*, Heinemann, London, 1983.

Morgan, Michael Hamilton, *Lost History, the Enduring Legacy of Muslim Scientists, thinkers, and Artist*, National Geographic, Washington, DC, 2007, p. 112.

Newton, Isaac, *The Principia*, Prometheus Books, New York, 1995.

O'Regan, Gerard, *A Brief History of Computing*, Springer-Verlag, London, 2008.

Porter, Duncan M. & Graham, Peter W. Ed., *The Portable Darwin*, Penguin, USA, 1993.

Quammen, David, *The Reluctant Mr. Darwin*, W.W. Norton and Company, New York, 2006.

Sagan, Carl, *The Demon-Haunted World*, Ballantine Books, New York, 1996.

Singh, Simon, *Big Bang*, Harper Perennial, New York, 2004.

Sobel, Dava, *Galileo's Daughter: A Historical Memoir of Science, Faith and Love*, Walker & Company, New York, 1999.

Stein, Sherman, *Archimedes – What Did he Do Besides...* Math. Assoc. Of America, United States of America, 1999.

Taton, René (editor), *Ancient and Medieval Science – from the Beginnings to 1450*, translated by A.J. Pomerans, Basic Books, New York, 1957.

Watson, James D, *The Double Helix*, Atheneum Publishers, New York, 1968.

Weinberg, Steven, *First Three Minutes*, HarperCollins, New York, 1977.

Weiner, Jonathan, *The Beak of the Finch*, Vintage Books, New York, 1995.

White, Andrew Dickson, *A History of the Warfare of Science with Theology*, D. Appleton & Company, New York, 1896.

23 Endnotes

1. *Monkey Girl: Evolution, Education, Religion, and the Battle for America's Soul*, Humes, Edward, Harper Collins, New York, 2007.
2. Pappus VIII. p. 1060 (ed. Hults).
3. *The Demon-Haunted World*, Sagan, Carl, Ballantine Books, New York, 1996.
4. *First Three Minutes*, Weinberg, Steven, HarperCollins, New York, 1977, pp. 154–155.
5. *Lost History, the Enduring Legacy of Muslim Scientists, thinkers, and Artist*, Morgan, Michael Hamilton, National Geographic, Washington, DC, 2007, p. 112.
6. *Galileo's Daughter: A Historical Memoir of Science, Faith and Love*, Sobel, Dava, Walker & Company, New York, 1999.
7. *A History of Western Science*, Alioto, Anthony, 2nd ed., Prentice Hall, Englewood Cliffs, New Jersey, 1987, p. 218.
8. *SCIENCE and the Making of the Modern World*, Marks, John, Heinemann, London, 1983, p. 49.
9. *Principia Philosophiae*, Descartes, Rene, 1644.
10. *Principia*, Newton, Isaac, 1687, Translated by Andrew Motte, 1729.
11. *The Copernican Revolution*, Kuhn, Thomas, Harvard University Press, Cambridge, 1957.
12. Isaac Newton, letter to Robert Hooke, 1676.
13. *Elements of Chemistry*, Lavoisier, Antoine, 1789, translated by Robert Kerr, 1790.
14. Diderot, D., *L'Interpretation de la Nature*, (1754); quoted in Buchdahl, G., *The Image of Newton and Locke in the Age of Reason*, (London: Sheed and Ward, 1961), pp. 80–1.
15. *The Social Contract*, Rousseau, Jean Jacques, 1762.
16. *A History of Western Science*, Alioto, Anthony, 2nd ed., Prentice Hall, Englewood Cliffs, New Jersey, 1987, p. 194.
17. *Elements of Chemistry*, Lavoisier, Antoine, 1789, translated by Robert Kerr, 1790.
18. *Method of Chemical Nomenclature*, Lavoisier, Antoine, 1787.
19. *Crucibles: The Story of Chemistry*, Jaffe, Bernard, 4th ed., Dover, New York, 1976, p. 92.
20. *Experimental Enquiry into the Proportion of the Several Gases or Elastic Fluids, Constituting the Atmosphere*, Memoirs of the Literary and Philosophical Society of Manchester, 1, 244–58 (1805), Read Nov. 12, 1802.
21. *CRUCIBLES: THE STORY OF CHEMISTRY*, Jaffe, Bernard, 4th ed., Dover, New York, 1976, p. 99.
22. Ibid. p. 131.
23. Review: [untitled], Sarton, G., *Isis*, Vol. 20, No. 2 (Jan., 1934), p. 273.
24. Maxwell, James Clerk, “On Physical Lines of Force,” *Philosophical Magazine*, 21, 1861, pp. 20–4.
25. Morse, Samuel B., first electric telegraph message sent from Washington, DC to Baltimore on May 24, 1844.
26. Williams, L. Pearce, ed. *The Selected Correspondence of Michael Faraday*, vol. 2, Letter 670, Cambridge University Press, London, 1971, pp. 881–883.

27. Williams, L. Pearce, ed. *The Selected Correspondence of Michael Faraday*, vol. 2, Letter 670, Cambridge University Press, London, 1971, pp. 881-883.
28. Thomson, William, *On the age of the sun's heat*, Macmillan's Mag., 5, 288-93; PL, 1, 394-68 (1862).
29. Darwin, Charles, *The Autobiography of Charles Darwin*, John Murray, London, 1876.
30. Wallace, Alfred Russel, *My Life: A Record of Events and Opinions*, 1905.
31. Darwin, Charles, letter to Charles Lyell, June 18, 1858.
32. Gould, Stephen Jay, *Ever Since Darwin*, W.W. Norton and Company, New York, 1977, pp. 24-5.
33. Gould, Stephen Jay, *Ever Since Darwin*, W.W. Norton and Company, New York, 1977, p. 37.
34. Lincoln-Douglas debate for an Illinois seat in United States Senate, Charleston, Illinois, September 15, 1858.
35. Darwin, Charles, *The Autobiography of Charles Darwin*, John Murray, London, 1876, pp. 238-9.
36. Gould, Stephen Jay, *Ever Since Darwin*, W.W. Norton and Company, New York, 1977, p. 33.
37. Lurie, Edward, *Louis Agassiz – A Life in Science*, abridged edition, University of Chicago Press, Chicago, 1960, p. 255.
38. *Ibid.*, p. 260.
39. *Ibid.*, p. 264.
40. *Ibid.* p. 261.
41. *A Free Examination of Darwin's Treatise on the Origin of Species and of its American Reviewers*, Gray, Asa, Reprinted from the Atlantic Monthly for July, August, and October, 1860, Trubner & Co., London, 1861.
42. Karl Max letter to Ferdinand Lassalle, January 16, 1861.
43. *A History of Western Science*, Alioto, Anthony, 2nd ed., Prentice Hall, Englewood Cliffs, New Jersey, 1987, pp. 296-7.
44. *The Future of an Illusion*, Freud, Sigmund, 1927.
45. *Francis Galton: The Life and Work of a Victorian Genius*, Forrest, D.W., Taplinger, New York, 1974, p. 189.
46. Calvin, J., *Institutes of the Christian Religion*, 2 vols, Battles, F.L. (trans.) London: SCM (1961/2).
47. James Woodrow, *Evolution*, An Address Delivered May 7th, 1884, Before the Alumni of the Presbyterian Seminary of Columbia, South Carolina.
48. *Evolution and Dogma*, Zahm, John Augustine, 1896.
49. *Social Statics*, Herbert Spencer, Pt. II, Ch. 17, *The Rights of Children*, 1851.
50. *Autobiography of Andrew Carnegie*, Carnegie, Andrew, Riverside Press, Cambridge, 1920.
51. John D. Rockefeller was reported to have said this in a Sunday-school address.
52. *What Social Classes Owe to Each Other*, Sumner, William Graham, Harper & Brothers, 1883.
53. *The Quantum Mechanics of Black Holes*, Hawking, Stephen, Scientific American, **236**, 1977, p. 40.
54. *Microscopical Researches into the Accordance in the Structure and Growth of Animals and Plants*, Schwann, Theodor, 1839, Trans. Smith, Henry, The Sydenham Society, London, 1847.

55. *Experiments in Plant-hybridisation*, Mendel, G., 1866, trans. *Mendel's Principles of Heredity*, Bateson, W., Cambridge, 1902.
56. Ibid.
57. Ibid.
58. Ibid.
59. Ibid.
60. *Crucibles: The Story of Chemistry*, Jaffe, Bernard, 4th ed., Dover, New York, 1976, pp. 245–6.
61. Letter for Gifford Pinchot from James Wilson, reported to have been written by Pinchot himself, March 3, 1905.
62. *Conservation in the Progressive Era*, Stradling, David, University of Washington, Seattle, 2004.
63. *Silent Spring*, Carson, Rachel, Houghton Mifflin, Boston, 1962, p. 16.
64. *The Essential Darwin*, Jastrow, Robert, General Editor, Little Brown & Company, Canada, 1984.