

Lean Six Sigma: Research and Practice

Dr. Maneesh Kumar; Professor Jiju Antony



Professor Jiju Antony & Dr. Maneesh Kumar

Lean Six Sigma: Research and Practice

Lean Six Sigma: Research and Practice

© 2014 Professor Jiju Antony, Dr. Maneesh Kumar & bookboon.com

ISBN 978-87-7681-768-8

Contents

	List of Editors and Contributors	10
	Acknowledgements	12
	Introduction to Book	13
1	Does Size matter for Six Sigma implementation?	17
	Abstract	17
	Introduction	18
	Literature Review	20
	Research Methodology	21
	Sampling method and procedure	21
	Findings from the survey	21
	Conclusion	30
	References	31
2	Lean Six Sigma: Exploring future potential and challenges	35
	Abstract	35

2.1	Introduction	36
2.2	Evolution of the Lean Six Sigma methodology	36
2.3	Key differences between Lean and Six Sigma	37
2.4	Advantages and disadvantages of LSS	39
2.5	Research Survey	39
2.6	Key Opportunities and the Future	42
2.7	Paper Conclusions	44
2.8	References	45
3	Lean Production implementation: case studies in Italian non repetitive companies	46
	Abstract	46
3.1	Introduction	46
3.2	Literature review and research objectives	47
3.3	Research model and methodology	50
3.4	Case Studies empirical results	51
3.5	Conclusions and future developments	59
3.6	References	59
4	Development of a 5S Sustainability Model for use with Lean and/or Six Sigma projects	62
	Abstract	62
4.1	Introduction	62
4.2	Market Need	63

4.3	Software Application Evaluation	64
4.4	5S Sustainability Audit Development	65
4.5	Proof of Concept Testing	67
4.6	Analysis of Data	69
4.7	Conclusions and Recommendations	72
4.8	References	72
5	The Impact of 5-S on Organizational Culture: A case study	73
	Abstract	73
5.1	Introduction	74
5.2	Literature Review	74
5.3	Methodology	77
5.4	Results	78
5.5	Conclusion	84
5.6	References	85
6	Application of Design for Six Sigma Processes to the Design of an Aero Gas Turbine	87
	Abstract	88
6.1	Introduction	88
6.2	Define	89
6.3	Characterise	95
6.4	Optimise	100

6.5	Verify	103
6.6	Application of DFSS to a HP Turbine Disc	105
6.7	Conclusions	117
6.8	References	118
7	Creating a Product Development Process Integrating DFSS at XYZ	119
	Abstract	119
7.1	Introduction	119
7.2	XYZ and the Need for Design for Six Sigma	120
7.3	Integration vs. Project-Driven Design for Six Sigma	122
7.4	Requirements on the new Product Development Process	123
7.5	Developing for Six Sigma at XYZ – the Process on a Map	127
7.6	DFSS Infrastructure at XYZ	130
7.7	Discussion	132
7.8	Conclusions	135
7.9	References	135
8	Six Sigma in Administration – past its use by date?	137
	Abstract	137
8.1	Introduction	137
8.2	Literature Review	138
8.3	Methodology & Case Study	143

8.4	Results	144
8.5	Critical Success Factors	147
8.6	Managerial Implications	148
8.7	Conclusions	149
8.8	References	149
9	Expected Role of Management Accounting Within The Six Sigma	
	Methodology: Case Evidence	151
	Abstract	152
9.1	Introduction	152
9.3	Research Methodology	161
9.4	Findings	162
9.5	Conclusion	170
9.6	References	171
10	What Makes Lean / Six Sigma Succeed	175
	Abstract	175
10.1	Introduction	175
10.2	The three elements of Lean / Six Sigma Success	178
10.3	Experiential Improvement Model – A Case Study	181
10.4	Conclusion	187
10.5	References	189

11	Enhancing the Six Sigma Problem-Solving Methodology Using the Soft Systems Methodology	190
	Abstract	190
11.1	Introduction	191
11.2	Criticisms of Six Sigma	191
11.3	Problem-Solving	192
11.4	Soft Systems Methodology	194
11.5	Conclusions	195
11.6	References	195
12	The Integration of Six Sigma and Green Supply Chain Management	199
	Abstract	199
12.1	Introduction	199
12.2	Six Sigma	200
12.3	Green Supply Chain Management	201
12.4	Potential research areas of Six Sigma and Green Supply Chain Management	202
12.5	Green Six Sigma arising from cases	205
12.6	Conclusion	206
12.7	References	207

List of Editors and Contributors

Editors

Jiju Antony is a Professor of Quality Management at Department of Design Manufacturing Engineering Management, University of Strathclyde, Glasgow, UK

Maneesh Kumar is a Lecturer in the School of Management, Edinburgh Napier University, Edinburgh, UK

Contributors

Alan Harrison is the Lean Six Sigma Practitioner & Fellow of Chartered Quality Institute, UK

Alberto Portioli Staudacher is in the Department of Management, Economics and Industrial Engineering, Politecnico di Milano, Milano, Italy

Alessandro Brun is in the Department of Management, Economics and Industrial Engineering, Politecnico di Milano, Via G.Colombo, Milan, Italy

Alex Douglas is the Reader in Service Quality Management at the Liverpool Business School, John Moores University, Liverpool, UK

Andrew Monks is in the Strategy & Business Analysis Subject Group, Faculty of Business and Law, Leeds Metropolitan University, UK

Annika Ölme works in the Product Development & Engineering Platforms Department of XYZ, Gothenburg, Sweden

Brian Wright is in the School of Business and Economics, University of Exeter, Streatham Court, Rennes Drive, Exeter, UK

Dr Phil Rowe is associated with the Burton Group, Rugby, UK

Gamini Lanarolle is in the Department of Textile & Clothing Technology, University of Moratuwa, Moratuwa, Sri Lanka

Gordon May is associated with the Aerospace Equipment Manufacturer in the UK

Helen Reynolds is a Quality Manager at a Lighting manufacturing firm in the Scotland, UK

Indra Devi Rajamanoharan is in the Faculty of Accountancy and Accounting Research Institute, Universiti Teknologi MARA, 14th Floor, Menara SAAS, 40450, Shah Alam, Selangor. Malaysia

James Marsh is the Faculty of ACES at Sheffield Hallam University, Howard Street, Sheffield, UK

Marco Tantardini is in the Department of Management, Economics and Industrial Engineering, Politecnico di Milano, Milano, Italy

Ollie Jones is in the Strategy & Business Analysis Subject Group, Faculty of Business and Law, Leeds Metropolitan University, UK

Paul Collier is in the School of Business and Economics, University of Exeter, Streatham Court, Rennes Drive, Exeter, UK

Sandra Middleton is in the Liverpool Business School, John Moores University, 98 Mount Pleasant, Liverpool, UK

Terrence Perera is the Faculty of ACES at Sheffield Hallam University, Howard Street, Sheffield, UK

Torben Hasenkamp is in the Division of Quality Sciences, Department of Technology Management & Economics, Chalmers University of Technology, Gothenburg, Sweden

Vijitha Ratnayake is in the Department of Textile & Clothing Technology, University of Moratuwa, Moratuwa, Sri Lanka

Xixi Fan is in the Department of Management, Economics and Industrial Engineering, Politecnico di Milano, Via G.Colombo, Milan, Italy

Acknowledgements

As editors, we have benefited from the advice and help of a number of people in the preparation of this book. This collection of ideas on Lean/ Six Sigma research was conceived during the year 2009-2010 when the editors have already organised and hosted Three International Conferences on Six Sigma and two European Research Conferences on Continuous Improvement and Lean Six Sigma. The chapters included in this book were extracted from the conference proceedings of the aforementioned conferences that were edited by Professor Antony of University of Strathclyde and Dr Kumar of Edinburgh Napier University. We are intellectually indebted to the many academics and practitioners whose research and writing have blazed new trails and advanced the discipline of Lean Six Sigma and Design for Six Sigma research. We also thank all reviewers who have provided their valuable comments in improving the quality of articles submitted and presented at the International and European Conference organized by the editors.

It is our sincere hope that by reading this book you will find something new or at least appreciate the research work carried out by the contributors. As always we welcome your thoughts about this book. Your suggestions, comments and feedback regarding the coverage and contents will be taken to heart, and we will always be grateful for the time you take to call to our attention to printing errors, deficiencies and other shortcomings. We thank our Publisher BookBooN.com Ltd in Denmark for their encouragement and forbearance during editing of this book. For all of the many people with BookBooN.com Ltd who helped us- a big thank you.

Finally, the editors would like to acknowledge the following publishers for having given permission to reproduce articles in this book:

International Journal of Six Sigma and Competitive Advantage- Inderscience Publishers

The TQM Journal- Emerald Group Publishing Limited

Professor Jiju Antony & Dr. Maneesh Kumar

Introduction to Book

This book is compiled to provide the reader a critical appreciation of key tools of Lean and Six Sigma and their implementation into both manufacturing and service organizations through drawing upon the research findings of a range of specialist scholars (including academics and practitioners) who have either proposed a conceptual model of framework for Lean/Six Sigma or have empirically gathered an extensive range of new data from organizations in the manufacturing and service sectors across a number of countries. The book integrates the research and practical elements of Lean and Six Sigma approaches to business improvement and also explores the challenges faced and issues raised when applying it in organizations- and critical success factors identified in resolving those challenges. This book is primarily aimed at advanced undergraduates, postgraduates / post-experience students, quality management and improvement practitioners, Lean Six Sigma practitioners, and researchers engaged in Lean Six Sigma.

Before we provide an executive summary of the main issues arising from the chapters, we felt that it was important to give an executive introduction to Lean and Six Sigma covering aspects such as definitions, principles, methodology, and their benefits. We will encourage readers to refer to other Lean / Six Sigma textbooks for more detailed information on the theoretical implications of Lean / Six Sigma.

What is Six Sigma and Lean?

In the last few decades, there existed many programs that have purported to be the answer to industry's process management problems. These include zero defects, management by objectives, quality circles, TQM and Business Process Reengineering. While these initiatives enjoyed some success, in the long run most of them were considered as a passing fad by the management and staff of different corporations. At the same juncture, during late 1980s, two other business improvement strategies evolved (namely Lean and Six Sigma) that were cynosure for resolving quality or process related problems in manufacturing and service industries and having significant impact on the bottom-line of corporations globally. Six Sigma and Lean Manufacturing are the two most popular and successful programs espoused by the industries over the last few decades. Many companies such as Toyota, Danaher Corporation, General Electric, Motorola and many others have achieved impressive results by implementing either a Lean or Six Sigma methodology in their organisation.

Six Sigma, originated in Motorola in mid 1980s, brought revolution in the industries worldwide and has become the long term business strategy to achieve competitive advantage and to excel in operations excellence. Six Sigma is widely recognized as a methodology that employs statistical and non-statistical tools and techniques to maximize an organization's Return on Investment (ROI) through the elimination of defects in processes.

The perception of Six Sigma has changed drastically from being a statistical tool to being a company-wide strategy for business process improvement. Organizations have included Six Sigma as a part of their business strategy and in the strategic review process to become globally competitive, increase market share, and enhance customer satisfaction. It takes us away from "*intuition based decisions-what we think is wrong, to fact based decision-what we know is wrong*". Six Sigma's success has been attributed to embracing it as an improvement strategy, philosophy and a way of doing business (. General Electric (GE) CEO Jack Welch described Six Sigma as "*the most challenging and potentially rewarding initiative we have ever undertaken at General Electric*".

Six Sigma is not just about statistics. The Six Sigma drive for defect reduction, process improvement and customer satisfaction are based on the “statistical thinking” paradigm, a philosophy of action and learning based on process, variation and data. Statistical thinking provides practitioners with the means to view processes holistically. There is a logical thought progression from process-variation-data to Define-Measure-Analyse-Improve-Control (DMAIC). Six Sigma aims at achieving 3.4 defects per million opportunities (DPMO) with an assumption that the process mean shift by as much as 1.5 standard deviation off the target.

Lean Manufacturing, on the other hand, was another quality initiative proposed by Americans in response to compete with Japanese manufacturers and its superior manufacturing techniques (following the concept of Toyota Production System (TPS) to resolve quality problems in their organization) as their import became serious concern to western producers. Similar to the concept of TPS, which focuses on waste reduction through quality control, quality assurance and respect for people, the basic principle of Lean Manufacturing was to reduce cost and enhance the speed of organization by minimizing seven types of waste (overproduction, motion, transportation, inventory, extra processing, waiting, and defect) through everyone involvement and continuous improvement by employing practices such as Just-in-Time (JIT), cellular manufacturing, Total Productive Maintenance (TPM), Kanban, Mistake Proofing, to name a few.

Lean is considered to be one of the most influential initiatives in manufacturing and its application is expanding to service industry, particularly healthcare, and public sector. The application of Lean principles have resulted in reduction of wastes, that drove practices such as inventory reduction, process simplification, and identification of non-value added activities and thereby cost reductions and customer satisfaction in many organizations.

Proper implementation of the two methodologies had proven to achieve dramatic results in terms of cost, quality, and delivery by focussing on process performance. The effective implementation of these methodologies involve top management commitment, cultural change in organisations, good communication down the hierarchy, new approaches to production and to servicing customers and a higher degree of training and education of employees. The integration of two methodologies can achieve better results than what either system could not achieve alone. While, Lean strategies play an important role in eliminating waste and non-value added activities across the organisation, Six Sigma, through the use of statistical tools and techniques take an organization to an improved level of process performance and capability. The two methodologies emphasize the unfathomable involvement of top executives and communication with the bottom line to develop robust products and processes in their organisation.

Introduction to Chapters

The focus of *Chapter 1* paper is to identify the quality initiatives implemented in UK manufacturing Small and Medium-Sized Enterprises (SMEs) and perform a comparative analysis of quality management practices within Six Sigma firms against the non-Six Sigma manufacturing SMEs. The findings from the study revealed that there is a significant difference in the performance of the Six Sigma / Lean firms against ISO certified companies. However, it is interesting to reflect to the findings of critical success factors (CSFs) of the sample firms. There is no significant difference in the perceived importance of the identified CSFs variables in the Six Sigma and ISO certified SMEs.

Chapter 2 explores the future of Lean Six Sigma (LSS) by posing a question - Where does LSS go from here? There are several potential avenues that LSS could follow, some of these may occur in an organic way or may be driven by unforeseen events, for example, the recent global recession. But with an ever increasing focus on the environmental impact of human activities, there is a developing need to combine LSS with environmental management techniques. These two methods complement each other on several levels and should provide additional benefits in the implementation environmental managements processes such as ISO 14001.

Chapter 3 investigates the application of Lean in a non repetitive environment in nine case study firms in Italy, and highlight differences with repetitive ones, focusing on a few key elements of Lean Production. The nine case studies in Italian non repetitive companies explores how non repetitive companies identify flow (value stream), implement pull production, use takt time and care of quality and standardization. As well, the Chapter analyses how non repetitive companies push Lean along supply chain and how they organize organizational structure.

A 5S sustainability model using the DMAIC approach was proposed in the *Chapter 4* that provides a means of measuring the level of achievement within various functions of an organisation across each phase of the 5S program. The model consists of an audit process designed around the 5S toolset aimed at all levels of the organisation. This provides an insight into the culture of the organisation and a general operational health-check of the 5S process in place at the company.

Similar to previous chapter, *Chapter 5* also examines the relationship between 5-S implementation has on an organizational culture. Direct observation through a case study approach was used along with surveys and questionnaires in a lighting manufacturing company in the UK. The findings revealed that the 5-S program was able to positively change the corporate culture in favour of Lean methodology.

The application of Design for Six Sigma (DFSS) was demonstrated in *Chapter 6* to design a high pressure turbine (HPT) disc. The Define, Characterise, Optimise and Verify (DCOV) methodology that showed the usage of some of the key tools within DFSS, such as: Quality Function Deployment (QFD), Design of Experiments, Surrogate modelling, Analytic Hierarchy Process (AHP), Monte Carlo simulation, Data Mining and parameter design. Another application of DFSS was discussed in *Chapter 7*, where authors show why and how XYZ implements DFSS in order to provide both academicians and managers with an example that invites further discussion about implementation of the methodology and contributes to clarifying the concept itself. XYZ's approach to implement DFSS is presented in this Chapter, including the background and reasons that may have led to it.

Chapter 8, 9, and 10 further explores the application of Six Sigma / Lean in service processes such as human resources and, management accounting processes. *Chapter 8* is among one of only a few studies in a European context on Six Sigma implementation in a non-technological function/area of business, and the first to rank critical success factors in a HR environment. This chapter also provides some key findings about the cross-pollination of methodologies, in particular Lean and Six Sigma. Similar study was conducted in *Chapter 10*, where the author has proposed a conceptual model for Six Sigma / Lean implementation within a HR environment. The Chapter presents pragmatic and experientially developed business improvement model that quickly and positively influences mind set, aligns people, drives right actions and behaviour, and delivers and sustains desired improvements.

Chapter 9 focuses on other aspect of service process, i.e. management accountancy, and emphasizes the role of accountants in execution of Six Sigma projects. Drawing on International Federation of Accountants' (IFAC) (1998) conceptual framework for management accounting, this study argues that many of the principal roles in the Six Sigma (SS) DMAIC process fit closely with IFAC's four key roles for management accounting. The results showed that the Six Sigma features applicable at all phases of the DMAIC process match closely with IFAC's key roles for management accounting.

Chapter 11 and 12 are conceptual papers, where authors have linked Six Sigma with other strategies/methods/ concepts such as soft system methodology (SSM) and Green Supply Chain Management. Authors in *Chapter 11* have reviewed extant literature to evaluate the integration of SSM with the Six Sigma DMAIC approach, making it more effective and applicable to both simple and complex problem situations. Introducing Six Sigma into Green Supply Chain management is proposed in *Chapter 12* by describing what organizations practicing Green Supply Chain Management can gain from Six Sigma and what Six Sigma practitioners can benefit on exploring Green Supply Chain Management.

1 Does Size matter for Six Sigma implementation?

- Findings from the survey in UK SMEs

Maneesh Kumar*

School of Management and Law, The Business School, Edinburgh Napier University, Edinburgh -
EH14 1DJ, Scotland, UK

Email: m.kumar@napier.ac.uk

Jiju Antony

Department of Design Manufacture and Engineering Management
Strathclyde Institute of Operations Management

University of Strathclyde
Glasgow, United Kingdom

Email: jiju.antony@strath.ac.uk

Alex Douglas

Liverpool Business School,
John Moores University, Liverpool, UK

Email: A.Douglas@ljmu.ac.uk

Abstract

The focus of this paper is to identify the quality initiatives implemented in UK manufacturing Small and Medium-Sized Enterprises (SMEs) and perform a comparative analysis of quality management practices within Six Sigma firms against the non-Six Sigma manufacturing SMEs. Very few studies have been reported about the successful applications of Six Sigma in SMEs. To achieve the research objective, a survey based approach is adopted by designing a short questionnaire addressing the issues of quality practices in SMEs. This article encompasses the survey results from the first phase of Doctoral study to identify Six Sigma and Non-Six Sigma companies. The findings from the study revealed that there is a significant difference in the performance of the Six Sigma / Lean firms against ISO certified companies. However, it is interesting to reflect to the findings of critical success factors (CSFs) of the sample firms. There is no significant difference in the perceived importance of the identified CSFs variables in the Six Sigma and ISO certified SMEs. The novelty of the paper lies in conducting a comparative study on the performance of Six Sigma and non-Six Sigma UK SMEs and drawing out value lesson for the academics, consultants, researchers and practitioners of continuous improvement initiatives like Lean and Six Sigma. The small sample size and focus on manufacturing sector limits its generalizability to entire SME population. Future study should focus on performing a comparative study of manufacturing and service based SMEs in UK or Europe.

Keywords: Six Sigma, SMEs, Survey, CSFs, Performance Measures

Introduction

From 1980s onward, with the globalisation of the world market, a continuous trend towards downsizing of large firms and business outsourcing to smaller firms seems to be the latest trend. With the beginning of the new millennium, the degree of productivity demonstrated by small firms will be vital to a continued economic surge (Kuratko et al 2001). The small and medium-sized enterprises (SMEs) constitute the bulk of enterprise with the major contribution to private sector output and employment in all economies of the world (Lin 1998, Antony 2005). SMEs contribution to world economy can be adjudged from the following:

- European Union- SMEs are economically important with 98% of an estimated 19.3 million enterprises defined as SMEs, providing around 65 million jobs (66%) and more than half (52%) of private sector turnover (EUROSTAT 2003);
- The OECD Countries- SMEs represent over 95% of enterprises in each of the 30 member countries and generate over half of private sector turnover (Organization for Economic Co-operation and Development (OECD) 2003);
- 99% of all enterprises in China are SMEs, providing employment to 75% of total workforce (China's Services SMEs 2002).
- In UK, SMEs economic significance and contribution in generating income and sustaining employment has been widely recognised by the government and policy makers (Jayawarna et al 2003). According to the recent survey by Small Business Service (SBS), an agency of the Department of Trade and Industry (DTI), out of 4.3 million business enterprise, 99.9% are SMEs [99.3% were small (0-49 employees) with only 0.6 % (26,000) of medium sized (50-249 employees)] and 6000 (0.1 %) large companies [>250 employees](DTI 2005). In terms of employment and annual turnover, SMEs account for 58.5 % and 51.3% respectively (DTI 2005).

To adhere to one common definition of SME, this research considers an organization to be an SME if it has less than 250 employees as stated by European Commission (2003) and DTI(2005). In regards to the 'quality' effort in SMEs as compared to large firms, there has not been a great deal of research (Kuratko 2001). A few articles that mention the quality effort in SMEs tend to be conceptual with little empirical findings. 'Quality' has emerged as a key management concern since the beginning of the 1980s and has become essential to the success and survival of any business, large or small (North et al 1998). Organizations not delivering reliable, defect-free products or services have ceased to be serious competitors.

In recent years, thinking about quality issues has spawned a host of quality management strategies. In the quest for quality, organisations have pursued formalised change programmes or quality initiatives such as: Total Quality Management (TQM), continuous improvement methodologies such as Kaizen (Hamel and Prahalad 1994); breakthrough improvement methodologies such as Business Process Re-Engineering (BPR) (Grover et al 1995); and more recently Six Sigma (Kumar et al 2006). Six Sigma has evolved significantly and continues to expand since its inception at Motorola in the mid 1980s to improve the process performance, enhance business profitability and increase customer satisfaction. Six Sigma is considered one of the most effective improvement drives among a large number of multinational organisations, with its adoption showing an upward trend (Desai 2006).

Six Sigma is a highly structured process improvement framework that uses both statistical and non-statistical tools/techniques to eliminate process variation and thereby improve process performance and capability. The aim of Six Sigma is to keep the distance between the process average and the nearest tolerance limit to at least six standard deviations and thus reduce variability in products and processes in order to prevent defects (Wiklund and Wiklund 2002). Six Sigma aims at achieving 3.4 defects per million opportunities (DPMO) with an assumption that the process mean shifts by 1.5 standard deviation off the target value. It provides business executives and leaders with the strategy, methodology, infrastructure, tools and techniques to change the way businesses are run.

The adoption of Six Sigma as a business strategy by large multinational corporations such as General Electric, Honeywell, Motorola, Seagate Technology, Caterpillar, Raytheon, ABB, Bombardier and Sony, to name a few, has resulted in publication of reports in the professional magazines and journals about the success achieved by these organisations after the implementation of Six Sigma. In spite of a number of Six Sigma success stories in large organisations, many SMEs are yet to be convinced of the benefits from the introduction, development, implementation and deployment of Six Sigma. The objective of this research is to investigate into the quality practices of SMEs and compare the differences in performance of Six Sigma and non-Six Sigma firms.

Literature Review

Once an owner of the business (in small firms) is convinced of the advantages conferred by Six Sigma and visualises the benefits, it is much easier to implement Six Sigma and to realise its benefits (Adams et al 2003). In small companies, the top management team need to be visibly supportive of every aspect of a Six Sigma initiative and they must demonstrate by their active participation, involvement and by their actions that such support is more than lip service (Adams et al 2003, Tennant 2001).

Snee and Hoerl (2003) argue that there is nothing inherent in Six Sigma that makes it more suitable for large companies. They also suggest that the greatest barrier to implementation in small companies to date has been the way major Six Sigma training providers have structured their offerings. More recently, as more and more sets of deployment guides and training materials have become available, the pricing structures have begun to change.

Researchers and practitioners have proposed frameworks or guidelines for Six Sigma deployment in SMEs (Spanyi and Wurtzel 2003, Gupta and Schultz 2005, Schwinn 2003, Waxer 2004, PQA 2003). The following points may be taken into account for the successful deployment of Six Sigma in SMEs.

- Visible management buy-in, commitment and support for Six Sigma deployment (Henderson and Evans 2000, Antony 2004);
- Linking Six Sigma to business strategy and customers (Henderson and Evans, 2000; Antony 2004, Antony and Fergusson 2004);
- Understanding the customer requirements;
- Shared understanding of core business processes and their critical characteristics;
- Training, rewarding and recognising the team members (Antony 2004, Antony and Fergusson 2004);
- Communicating the success and failure stories (Goldstein 2001);
- Selecting the right people and the right projects (Antony 2004, Antony and Fergusson 2004, Goldstein 2001);
- Monitoring cost of quality for identifying non-value added activities within the small business, reducing overheads to minimum and decimating the indirect costs (Huxtable 1995);
- Conducting monthly performance reviews (Goldstein 2001);
- Keeping everyone aware of Six Sigma through company meetings, postings and everyday activities.

The aforementioned factors may be considered as critical to the success of a Six Sigma program within SMEs. The idea of identifying Critical Success Factors (CSFs) as a basis for determining the information needs of managers was popularised by Rockart (1979).

Research Methodology

A survey based approach is used to identify and understand the continuous improvement (CI) initiatives prevalent or commonly and widely practised in SMEs. The survey instrument was constructed drawing upon prior literature on continuous improvement initiatives in SMEs and large organizations (Antony and Banuelas 2002, Ghobadian and Gallear 1996, Lee and Oakes 1995, Snee 2004, Wessel and Burcher 2004, Yusof and Aspinwall 1999, Antony et al 2005; Antony et al 2008, Kumar 2007). The survey instrument was designed with the purpose of identifying Six Sigma and non-Six Sigma companies within UK and understanding their quality management practices. The primary data collection method used to achieve the research objectives was postal questionnaires with the self-addressed return envelop targeted to Managing Directors, Operations Directors, Quality Managers, and Production Engineers within the sample.

Sampling method and procedure

The questionnaire was mailed out to 500 manufacturing SMEs in UK, which were randomly chosen from the FAME and Dun & Bradstreet database. After sending three reminders to sample companies, seventy-five questionnaires were returned with only sixty-four completed and valid responses. This resulted in the response rate of 12.8%, which is considered as an average response rate in researching manufacturing SMEs.

Findings from the survey

Demographic Information

The demographic details pertaining to sample companies includes information on the type of firm (local, joint venture, or part of multi-national corporation (MNC)); location of firm within UK; type of manufacturing industry which include 13 categories; size (small or medium); annual turnover ranging from less than £1 million to over £50 million; and position of the respondents including CEO/ Managing Director, departmental head, quality manager and others. These variables may also be termed as control variables, used in the later part of analysis to understand the quality practices within the sample firms.

Among the 64 responding SMEs, 49 firms (76.56%) are local, 14 (21.88%) firms are part of MNC and one being a joint venture company. Geographically, majority of the SMEs are located across UK (43 or 67.1%). The distribution of the 64 manufacturing firms by different industry is presented in table 1.1. It can be gauged from the table that the sample is representative of different kinds of manufacturing companies ranging from aerospace, automotive, electronics and semiconductors to food, paper and plastic manufacturing industry.

Industry specialization	Count
Automotive	2
Textiles	2
Chemical	2
Aerospace	3
Electrical	3
Pharmaceuticals	3
Printing/paper	5
Mechanical	6
Food	7
Electronics & Semiconductor	7
Others	24

Table 1.1: Industry Specialization of sample firms

One of the control variables included in the survey is the size of company, i.e. small (< 50 employees) and medium-sized company (50-249 employees). Twenty five percent of the respondents are small firms whereas seventy five percent of the respondents are medium-sized firms. A clustered bar chart is plotted for size of the company against its annual turnover, as shown in figure 1.1. Out of 64 companies, 4 companies were not happy to discuss their annual turnover and thus not plotted in the chart. The figure shows that there is a significant variation in annual turnover within each sub group (small and medium).

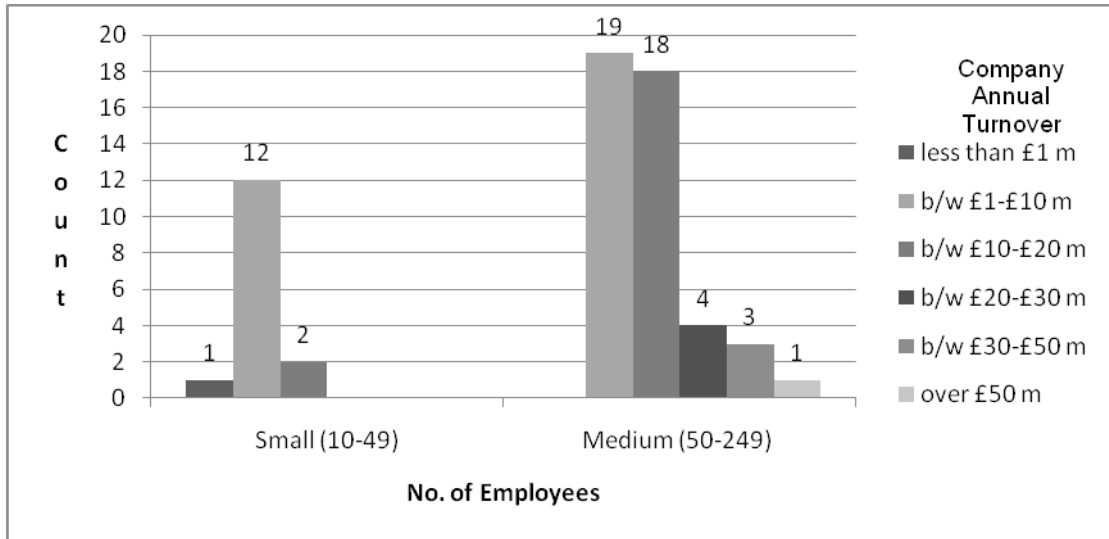

Figure 1.1: A clustered bar chart plot of size against company's annual turnover

History of Quality Initiatives in SMEs

The respondents were asked to list the quality initiatives implemented in the past or those currently deployed across their business functions. As depicted in table 1.2, majority of the SMEs were ISO certified followed by implementing Lean, Investors in People (IIP) and Six Sigma. None of the SMEs in the sample had implemented the European Foundation for Quality Management (EFQM) assessment model, which further confirms the argument in the literature that EFQM is not suitable for SMEs. The model is bureaucratic and time consuming, making it difficult for SMEs to allocate scarce resources for its implementation and follow-up.

Quality Initiatives Undertaken	Count	%
Six Sigma	10	15.6%
TQM	5	7.8%
Lean	17	26.6%
Kaizen	7	10.9%
BPR	1	1.6%
Theory of Constraints	1	1.6%
ISO 9000	49	76.6%
Investors in People (IIP)	10	15.9%
European Foundation for Quality Management (EFQM)	0	0%
Others	9	14.3%
No initiative undertaken	8	12.5%

Table 1.2: History of quality initiatives in SMEs

From the analysis, it was found that 12.5% of the responding companies do not have any kind of quality improvement methodology or system in place. The focus in these firms is more on productivity and meeting the customers' deadline. The majority of the respondents in other category were implementing British Retail Consortium (BRC) certification, especially within the food industry. Further in-depth analysis revealed that out of 49 certified ISO firms, 17 of the firms have implemented Lean and 10 of the 17 Lean firms have gone down the route of Six Sigma. This gives an indication that ISO may be the foundation or building block before embracing Lean and Six Sigma. This is an area of further research.

Customer focused measures in the firm

Respondents were given the option of multiple answers in order to capture all the measures existing within SMEs to understand the customer issues and problems. The results of the analysis are shown in table 1.3 below. Majority of the firms (89.1%) used customer complaints as a medium to understand the critical business issues followed by criteria such as delivery time (60.9%) and customer survey (59.4%). This indicates that rather than using proactive measures to capture voice of customer such as survey and focus group, SMEs prefer to operate in reactive mode by addressing the complaints from their key customers.

Customer Satisfaction Measures used	Count	%
Customer complaints	57	89.1%
Delivery times	39	60.9%
Surveys	38	59.4%
Repeat business	30	46.9%
Sales data	28	43.8%
Others	15	23.4%

Table 1.3: Measures used to capture voice of customers

The respondents were also asked to cite the three most important criteria that helped the firm to win customer loyalty. The criteria used to win orders were divided into seven categories and the results from the analysis shows that manufacturing quality, product reliability, and on-time delivery of the final product are the three most important criteria that SMEs focus on to win customer orders, as shown in figure 1.2. Criteria used to win customer loyalty were also tested against the size of the firm that identified manufacturing (mfg.) quality, product reliability, and on-time delivery as the three most important factors irrespective of the size of the firm.

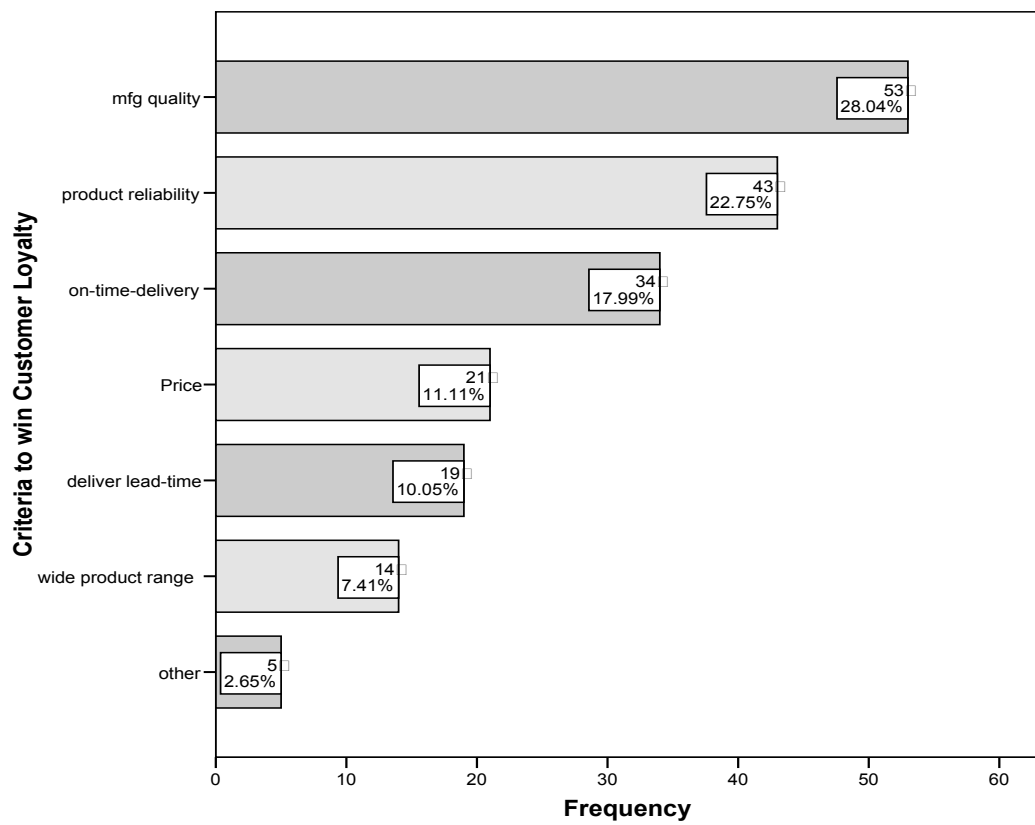

Figure 1.2: Criteria used to win customer loyalty

Reasons for not implementing Six Sigma in SMEs

Large organizations have been implementing and reaping the benefits of Six Sigma in the last two decades. However its application in SMEs is still less evident in the literature. It is important to understand the perception of Six Sigma and factors hindering its implementation from the SMEs perspective. Firms were asked to state the reasons for not implementing Six Sigma as an initiative to drive continuous improvement efforts within their firms.

Reasons for not implementing Six Sigma	Count
Lack of Knowledge of system to kick off	12
Not sure if relevant	9
Availability of Resources	8
Never heard	7
Cost issue	7
Other competing initiatives	6
ISO is accepted and necessary	5
Leadership Desire	5
Suitable for large company	3
Bureaucratic	2

Table 1.4: Reasons for not implementing Six Sigma in SMEs

As depicted in the table 1.4, the majority of the firms were discouraged to implement Six Sigma due to lack of knowledge of the system to kick off the initiative. This was followed by other reasons such as lack of resources, not sure if relevant, never heard, and cost issues. In the SMEs literature, the most common reason cited for not embarking on continuous improvement (CI) initiatives like TQM, Lean or Six Sigma is the availability of resources, commitment from the top management to invest in the required resources for successful implementation, and considering ISO certification as a destination to CI efforts. This study further enriches the literature by providing in-depth information on the reasons for not implementing Six Sigma.

Critical Success Factors (CSFs) study

The concept of identifying and applying CSFs to business problems is not a revolutionary new field of work (Caralli, 2004). It dates back to the original concept of *success factors*, as a basis for determining the information needs of managers, proposed by Daniel (1961) and popularized by Rockart (1979). CSFs are those factors which are critical to the success of any organisation, in the sense that, if objectives associated with the factors are not achieved, the organisation will fail - perhaps catastrophically so (Rockart, 1979).

The respondents were asked to rate the importance of CSFs within the company, with 1 corresponding to “not important at all” and 5 as “very important”. In order to find the gap between the importance of CSFs and its actual practice in-company, a similar rating scale (1 represents “very poor practice” and 5 corresponds to “very good practice”) was used to measure the extent of implementation of CSFs within the firms.

Critical Success Factors	Importance	Practice	GAP	Sig.*
Mgmt involvement & commitment	4.73	3.97	0.76	0.000
Communication	4.70	3.59	1.11	0.000
Link QI to employee	4.44	3.36	1.08	0.000
Cultural change	4.38	3.19	1.19	0.000
Education & training	4.27	3.27	1.00	0.000
Link QI to customer	4.22	3.36	0.86	0.000
Project selection	4.19	3.22	0.97	0.000
Link QI to Business	4.14	3.28	0.86	0.000
Link QI to supplier	4.14	2.97	1.17	0.000
Project mgmt skill	4.03	3.17	0.86	0.000
Org infrastructure	3.97	3.57	0.40	0.003
Vision & Plan	3.97	3.46	0.51	0.003
IT & innovation	3.83	3.17	0.66	0.002

* Test performed at 5% sig. level

Table 1.5: Gap analysis of CSFs of Quality Practices in SMEs

From table 1.5, it was found that management involvement and commitment is considered the most important factor and vision and plan statement and IT and innovation received the lowest mean value of importance. Most of the variables had a mean importance equal to or greater than 4. On the contrary, in practice within the company, each of these variables was found to be less applicable with mean practice value less than 4 for all factors.

A t-test was performed to identify whether the *mean* value for importance and actual practice of CSFs are statistically different from each other. The result of the analysis shows that each factor is statistically significant in terms of application and perceived importance of CSFs within SMEs. It can be inferred from table 1.5 that even though the company has got the quality systems or initiatives in place, still there is a huge gap in the level of importance and practice of CSFs, which may result in the poor organisational performance of the company. Comparison of CSFs between Six Sigma / Lean companies against ISO certified companies, details provided in table 1.6 below, revealed that there is no significant difference in terms of importance of the CSFs in Six Sigma and ISO certified companies. SMEs implementing ISO perceive the importance of these CSFs in a similar way as firms implementing Lean and Six Sigma.

Critical Success Factors	Six Sigma /Lean Company		ISO 9000 company	
	N*	Importance	N	Importance
Mgmt involment & commitment	17	4.88	30	4.67
Communication	17	4.82	30	4.67
Link QI [^] to employee	17	4.44	30	4.43
Cultural change	17	4.41	30	4.37
Education & training	17	4.47	30	4.20
Link QI to customer	17	4.38	30	4.17
Project selection	17	4.25	30	4.23
Link QI to Business	17	4.06	30	4.10
Link QI to supplier	17	4.00	30	4.23
Project mgmt skill	17	4.00	30	4.10
Org infrastructure	17	3.71	30	3.97
Vision & Plan	17	3.94	30	3.83
IT & innovation	17	3.56	30	3.93

*This sample includes company implementing Lean or Six Sigma

[^] QI stands for Quality Initiative

Table 1.6: Comparison of CSFs between Six Sigma/Lean against ISO Certified SMEs

From the CSFs findings, it clearly illustrates that irrespective of type of initiatives a SME is undertaking, management involvement and commitment is the most important factor to make the initiative successful followed by communication, employee involvement, culture change, training and focus on voice of customers. The top seven CSFs are related to the soft side or the human side of implementation rather than application of tools and techniques. The result reflects that it is the softer factors that make any change program successful rather than focusing more on the application of tools and techniques.

Barriers to implementation of quality initiatives in SMEs

Companies were asked to identify the top five inhibiting factors that were felt to be barriers to quality initiative implementation. The results of the analysis showed that about 71.2% percent of the responding firms stated lack of resources as one of the impeding factors to the successful introduction of quality initiatives in UK SMEs. Lack of resources covered a large number of aspects including financial resources, human resources, and time. This was followed by lack of knowledge, poor training/coaching, internal resistance, poor employee participation, to name a few.

Barriers to implementation of QI	Count	%
Availability of resources	42	71.2%
Lack of knowledge	35	59.3%
Lack of training	33	55.9%
Internal resistance	32	54.2%
Poor employee participation	27	45.8%
Inadequate process control techniques	24	40.7%
Changing business focus	21	35.6%
Lack of top mgmt commitment	18	30.5%
Poor delegation of authority	17	28.8%
Poor supplier involvement	16	27.1%
Poor project selection	5	8.9%

Table 1.7: Barriers to Implementation of Quality Improvement Initiatives in SMEs

Lack of resources is the most common impeding factors, as cited in the SMEs literature on CI initiatives that deters the progress of any change management programme in SMEs. The findings are similar to other researchers work on SMEs (Antony et al., 2005; Antony et al., 2007; Kumar, 2007).

Comparing the benefits of Six Sigma against ISO-certified surveyed companies

The respondents were asked to rate the benefits that quality initiatives had brought to their organisations since implementation. The respondents were asked to rate on a Likert scale of 1 to 5, where 1 = negative benefit, 3= some benefit and 5 = crucial. Table 1.8 summarises the key benefits gained from the implementation of Six Sigma and is compared against the performance of ISO certified companies with respect to variables mentioned in table 1.8. Testing of the mean performance of Six Sigma / Lean organizations against ISO certified firms revealed the significant differences in performance of an ISO certified SME as compared to a firm implementing Six Sigma.

Performance of seven Lean firms out of 17 (SMEs not implementing Six Sigma) were also recorded with respect to the variables mentioned in table and it was revealed that the mean performance of these firms were above ISO certified SMEs but below firms implementing Lean and Six Sigma. This analysis gives an indication that Lean firms implementing Six Sigma have realised more benefits as compared to SMEs implementing Lean on its own.

Performance Measures	SS / Lean Org.		Non- SS/Lean Org.		Sig.* value
	Mean	Std. Dev.	Mean	Std. Dev.	
Reduction in scrap rate	3.52	.829	2.82	.872	0.000
Reduction in cycle time	3.38	.875	2.80	.940	0.003
Reduction in delivery time	3.24	.872	2.84	.926	0.002
Increase in productivity	3.79	.726	2.84	.746	0.000
Reduction of cost	3.50	.777	2.88	.752	0.000
Increased profitability	3.40	.770	2.35	.797	0.000
Increased Sales	3.50	.900	3.04	.889	0.003
Reduction of customer complaints	3.65	.950	3.07	.961	0.003
Reduction of employee complaints	3.27	1.072	3.00	1.087	0.024

Table 1.8: Performance Measures of Six Sigma / Lean Company vs. Non- Six Sigma / Lean Company

Six Sigma firms are performing much better on the operational metrics like reduction in scrap rate, cycle time, delivery time and increase in productivity. Even in the strategic measures of organizational performance, i.e. reduction in cost, increased profitability and increase sales, Six Sigma and Lean firms outperform ISO certified SMEs.

Conclusion

This study presents the results of the survey conducted in UK manufacturing SMEs to investigate into their quality practices and measure its impact on the organizational performance of SMEs. Results of the survey revealed that factors critical to success of quality initiatives are equal in importance, irrespective of type of initiatives implemented by the firm. Management Commitment and Strong Leadership is required to make any change initiatives successful in the organization. It should also be linked to employees in terms of training, making resources available and establishing good communication with them. However, the operational and strategic performance metrics of SMEs implementing Six Sigma differs significantly to an ISO certified companies. This gives an indication that Six Sigma is beneficial for all type of firm, irrespective of the size of the firm. This statement needs to be further validated by conducting in-depth case-studies in SMEs implementing Six Sigma and compare with the performance of Non-Six Sigma firms. The second phase of this research project will address the aforementioned issues.

It is imperative for SMEs to have a strong management commitment and good leadership skills before embarking on the programme. Research had shown that Six Sigma initiative in many organizations have failed either due to lack of understanding of how to get started or due to failure to link the initiative to strategic business goals and measurable objectives. Management in such organizations are weak and often involved in fire-fighting, paying inadequate attention to softer issues such as leadership, culture change, employees training and education. If Six Sigma is only considered as implementation of statistical tools and techniques to solve complex problems in an organization, it is doomed to fail due to its very weak linkage to strategic business objectives.

References

Adams, C., Gupta, P. & Wilson, C 2003, *Six Sigma Deployment*, Butterworth-Heinemann, Burlington, MA.

Antony, J. & Banuelas, R 2002, 'Key ingredients for the effective implementation of Six Sigma program', *Measuring Business Excellence*, vol. 6, no.4, pp. 20-27.

Antony, J 2004, 'Six Sigma in the UK Service Organisations: results from a pilot survey', *Managerial Auditing Journal*, vol.19, no.8, pp. 1006-1013.

Antony, J. & Fergusson, C 2004, 'Six Sigma in the Software Industry: results from a pilot study', *Managerial Auditing Journal*, vol.19, no.8, pp.1025-1032.

Antony, J., Kumar, M., & Labib, A 2008, 'Gearing Six Sigma into UK Manufacturing SMEs: An Empirical assessment of Critical Success factors, Impediments, and viewpoints of Six Sigma implementation in SMEs', *Journal of Operations Research Society*, vol.59, no.4, pp.482-493

Antony, J., Kumar, M. & Madu, CN 2005, 'Six Sigma in Small and Medium Sized UK Manufacturing Enterprises: Some Empirical Observations', *International Journal of Quality and Reliability Management*, vol.22, no.8, pp.860-874.

Caralli, RA 2004, 'The Critical Success factor Method: Establishing a Foundation for Enterprise Security Management', *Technical Report, Carnegie Mellon Software Engineering Institute, CMU/SEI-2004-TR-010*.

China Service SMEs 2002, 'Fact', Retrieved 30th January, 2008 from http://www.sitrends.org/facts/figure.asp?FIGURE_ID=84

Daniel, RH 1961, 'Management data crisis', *Harvard Business Review*, September-October, pp.111-112.

Desai, DA 2006, 'Improving customer delivery commitments the Six Sigma way: case study of an Indian small scale industry', *International Journal of Six Sigma and Competitive Advantage*, vol.2, no.1, pp. 23-47.

DTI 2005, *National Statistics, Statistical Press Release*. Available from <http://www.sbs.gov.uk/content/analytical/statistics/combinedsmestats.pdf> [Accessed on 20th January, 2008]

European Commission 2003, SME definition: Commission Recommendation of 06 May 2003. http://ec.europa.eu/enterprise/enterprise_policy/sme_definition/index_en.htm

Retrieved 31st January 2008

EUROSTAT 2003, 'Competence development in SMEs', *Observatory of European SMEs*, 2003/1.

Ghobadian, A, & Gallea, DN 1996, 'Total quality management in SMEs', *Omega: International Journal of Management Science*, vol. 24, no. 1, pp.83-106.

Goldstein MD 2001, 'Six Sigma Program Success Factors', *Six Sigma Forum Magazine*, November 2001, pp.36-45.

Grover, V., Jeong, SR., Kettinger, WJ., & Teng, J.T.C 1995, 'The Implementation of Business Process Reengineering', *Journal of Management Information Systems*, vol.121, pp.109-144.

Gupta, P. & Schultz, B 2005, 'Six Sigma Success in Small Businesses', *Quality Digest*, April 5, 2005.

- Hamel, G., & Prahalad, CK 1994, *Competing for the Future: Breakthrough Strategies for Seizing Control of Your Industry and Creating the Markets of Tomorrow*, Harvard Business School Press, Boston, MA.
- Henderson, K., & Evans, J 2000, 'Successful implementation of Six Sigma: benchmarking General Electric Company', *Benchmarking and international Journal*, vol.7, pp 260-281.
- Huxtable, N 1995, *Small Business Total Quality*, Chapman & Hall, London.
- Jayawarna, D., Wilson, A., & Homan, G 2003, 'The Management Development Needs in Manufacturing SMEs: An Empirical Assessment', *Manchester Metropolitan University Business School Working Paper Series*, December, ISSN 1478-8209.
- Kumar, M 2007, 'Critical Success Factors and Hurdles to Six Sigma Implementation: the case of a UK manufacturing SME', *International Journal of Six Sigma and Competitive advantage*, vol. 3, no.4, pp. 333-351
- Kumar, M., Antony, J., Singh, RK., Tiwari, MK., & Perry, D 2006, 'Implementing the Lean Sigma Framework in an Indian SME: A Case Study', *Production Planning and Control*, vol.17, no. 4, pp. 407-423.
- Kuratko, DF., Goodale, JC., & Hornsby, JS 2001, 'Quality Practices for a Competitive Advantage in Smaller Firms', *Journal of Small Business Management*, vol.39, no.4, pp.293-311.
- Lee, GL. & Oakes, I 1995, 'The Pros and Cons of TQM for smaller forms in manufacturing: some experiences down the supply chain', *Total Quality Management*, vol. 6, pp 413-426.
- Lee, K., & Palmer, E 1999, 'An Empirical Examination of ISO 9000-Registered Companies in New Zealand', *Total Quality Management*, vol.10, no.6, pp.887-899.
- North, J., Blackburn, RA., & Curran, J 1998, *The Quality Business*, Routledge: New York, NY 10001
- OECD 2000, 'Small and Medium-sized Enterprise: Local Strength, Global Reach', *Policy Brief*, June 2000.
- Process Quality Associates 2003, Six Sigma for SMEs, Retrieved August 5th, 2007 from <http://www.pqa.net/sixsigma/>
- Rockart, J 1979, 'Chief executives define their own data needs', *Harvard Business Review*, vol. 57, no.2, pp 238-41.
- Schwinn, DR 2003, Six Sigma Simplified for Small Organisation. Available December 30th, 2007 from http://www.qualityadvisor/library/six_sigma/ .
- Snee, RD 2004, 'Six Sigma: The Evolution of 100 years of Business Improvement Methodology', *International Journal of Six Sigma and Competitive Advantage*, vol.1, no. 1, pp. 4-20.
- Snee, RD. & Hoerl, RW 2003, *Leading Six Sigma – A Step by Step Guide based on Experience at GE and other Six Sigma companies*, FT Prentice-Hall, NJ, USA.

Spanyi, A. & Wurtzel, M 2003, 'Six Sigma for the Rest of Us', *Quality Digest*, Retrieved 20th December, 2007 from http://www.qualitydigest.com/july03/articles/01_articles.html

Tennant, G 2001, *Six Sigma: SPC and TQM in Manufacturing and Services*, Ashgate Publishing, UK

Waxer, C 2004, Is Six Sigma Just for Large Companies? What about Small Companies?, Retrieved 22nd December, 2007 from <http://www.isixsigma.com/library/content/>

Wessel, G. & Burcher, P 2004, 'Six Sigma for Small and Medium-Sized Enterprises', *The TQM Magazine*, vol.16, no.4, pp. 264-272.

Wiklund, H. & Wiklund, PS 2002, 'Widening the Six Sigma concept: An approach to improve organizational learning', *Total Quality Management*, vol.132, pp.233-239.

Yusof, SM., & Aspinwall, E, 1999, 'Critical success factors for total quality management implementation in small and medium enterprises', *Total Quality Management*, vol. 10, no. 4/ 5, pp S803-S809.

2 Lean Six Sigma: Exploring future potential and challenges

James Marsh*, Terrence Perera

Faculty of ACES

Sheffield Hallam University, Howard Street, Sheffield S1 1WB, UK

Email: jamarsh8@my.shu.ac.uk , t.d.perera@shu.ac.uk

Gamini Lanarolle, Vijitha Ratnayake

Department of Textile & Clothing Technology

University of Moratuwa, Moratuwa, Sri Lanka.

Email: wilath@yahoo.com, vijitha@textile.mrt.ac.lk

Abstract

Lean Six Sigma (LSS) has evolved considerably from its original multiple roots of Taylor (time and motion), assembly line mass production, Toyota Production System (TPS), Statistical Process Control (SPC) and Total Quality Management (TQM) amongst others. It has combined into what is now an established global business improvement methodology. It has now transcended its origins within manufacturing to be found in virtually all industry sectors, most notably in recent years the service sector including healthcare and governmental.

My recent research has shown that overriding majority of users of Lean and/or Six Sigma has been trained in both Lean and Six Sigma. The combined synergy of Lean and Six Sigma has now become the most widely accepted methodology and this begs the question: Where does LSS go from here? There are several potential avenues that LSS could follow, some of these may occur in an organic way or may be driven by unforeseen events, for example, the recent global recession. Recent advances in technology are also changing the face of LSS and its method of deployment at local levels and more globally. These changes may open up the approach to a wider array of users and industries.

But with an ever increasing focus on the environmental impact of human activities, there is a developing need to combine LSS with environmental management techniques. These two methods complement each other on several levels and should provide additional benefits in the implementation environmental managements processes such as ISO 14001. This paper therefore explores in further detail the potential next steps for LSS and what this could mean for the industries of tomorrow as they adjust to changing business and environment challenges

Key Words: Lean, Six Sigma, Future Challenges, Sustainability, Value Stream Mapping

2.1 Introduction

The use of Lean Six Sigma (LSS) as a business improvement methodology has increased significantly over the last decade and its usage has broadened from the manufacturing sector to virtually every industry sector and developed country there is. Its ability to be applicable in this way is quite probably unique as it continues to spread out and grow in more diverse business sectors including pharmaceutical and banking.

2.2 Evolution of the Lean Six Sigma methodology

LSS has evolved during a journey that can be traced back well over a century. This family tree, depicted in Figure 2.1, clearly demonstrates how LSS followed two completely different paths and only converged in recent years to become what is now the most accepted methodology namely Lean Six Sigma.

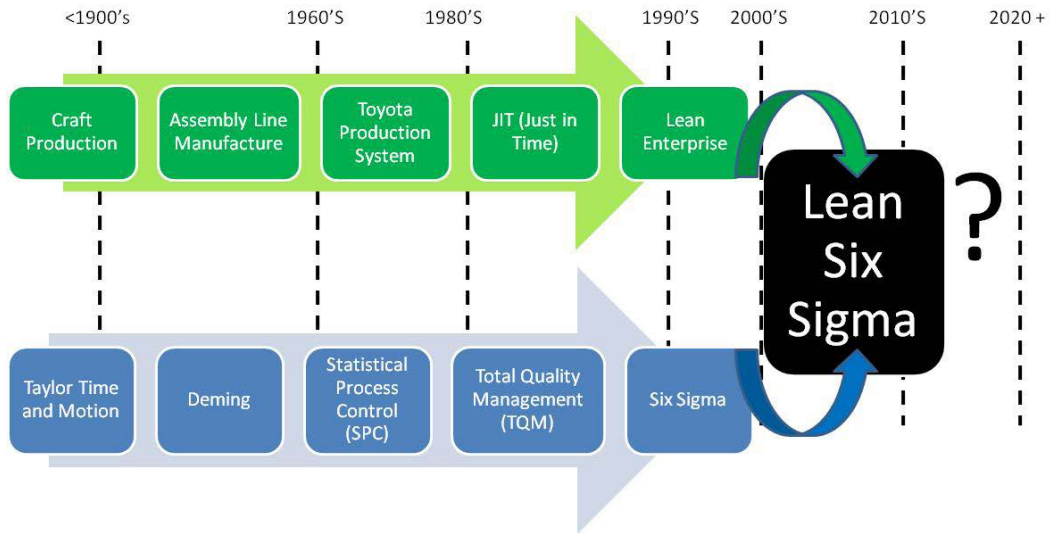

Figure 2.1: Evolution of Lean Six Sigma

Our recent research (Section 2.5) on the Lean and/or Six Sigma user base has shown that 50.3% of Lean and/or Six Sigma users have received training in both Lean and Six Sigma. This compares with 20.8% having received training in Lean only and 14.5% in Six Sigma only. The remaining 14.4% of the survey had received no formal training at all.

This suggests that the LSS approach is now the most widely used approach and has replaced Lean and Six Sigma as individual methodologies and must now be identified as the most commonly applied approach. This is a significant change over the last decade where many users stood faithful to either Lean or Six Sigma and the benefits of combining the approaches were not accepted by the different user communities. There is still evidence of this non acceptance on many Lean and or Six Sigma forums discussions but from experience this tends to be a mixture of traditional users with bad experiences from poorly managed LSS deployments.

2.3 Key differences between Lean and Six Sigma

Lean and Six Sigma are both business improvement methodologies but they have some important fundamental differences. These differences are well documented in numerous academic research papers e.g. (Antony and Escamilla 2003), but can be summarised in Figure 2.2 below: -

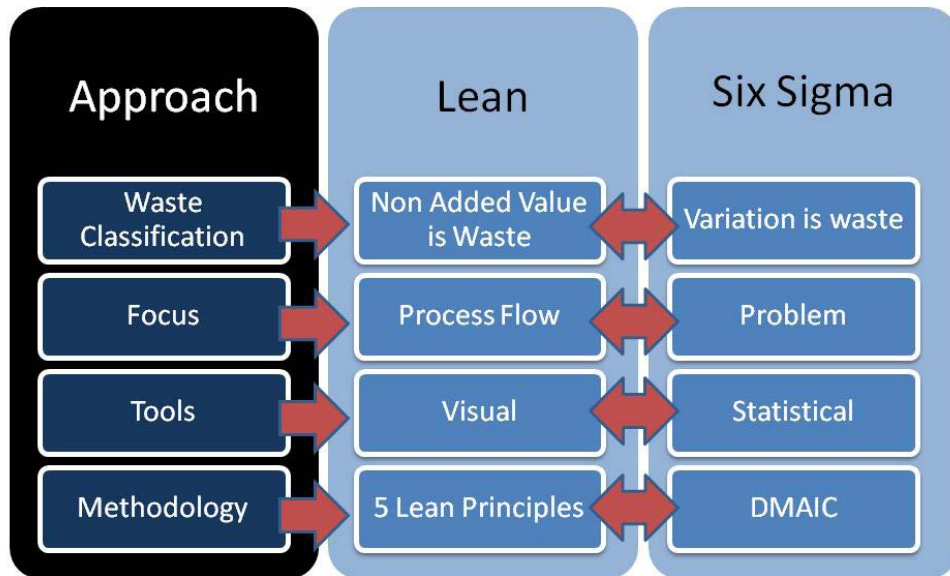

Figure 2.2: Key differences between Lean and Six Sigma Approaches

In simplistic terms, Lean is much more than just about reducing and eliminating process wastes, it is a philosophy that can be applied in a continuous form for years if not decades. Toyota was the leader in this philosophy which is still highly relevant today. Six Sigma meanwhile concentrates on the reduction/elimination of problems, which could manifest themselves in the form of defects or variation. The Six Sigma approach tends to be much more finite than Lean and mostly last over a period of weeks to months.

2.4 Advantages and disadvantages of LSS

There are many publications on the pros and cons of Lean or Six Sigma (Wiesenfelder 2009) but much less is known about the combined LSS approach. What is well known however, is that when implemented correctly the benefits of combining Lean and Six Sigma makes it a formidable business improvement methodology (Snyder and Peters 2004).

However there are issues with the combined LSS approach which if not resolved can result in unsuccessful implementations. The first thing to consider is the expertise and awareness of the two approaches existing within the organisation and the chosen project team. Personal experience of LSS implementations has shown that there can be a mix or unbalance of awareness and expertise in Lean and Six Sigma. Therefore there is a possibility that there could be situations where some stakeholders have only used Lean and not Six Sigma and vice versa as our research has identified. This would require a review of the expertise in a given area and additional time and budget may be required to get the team to the same level of knowledge and capability.

Another issue is the lack of clarity of LSS as an approach. Lean has the 5 Lean principles and Six Sigma has adopted the DMAIC approach, but there is not a specific industry wide accepted LSS approach. What we have in reality is a mix of tailored approaches developed by LSS organisations, consultancy companies or in-house. There is in practice resulting variation in the quality of these bespoke approaches in their principles and application.

2.5 Research Survey

A research survey was developed by the paper's authors and issued globally to the LSS community via various means including industry contacts and forums. A total of 173 responses were collected, the majority of responses from Northern America (41%), Europe (28.9%) and Asia 25.5%. The percentage of these responses is depicted in Figure 2.3 below: -

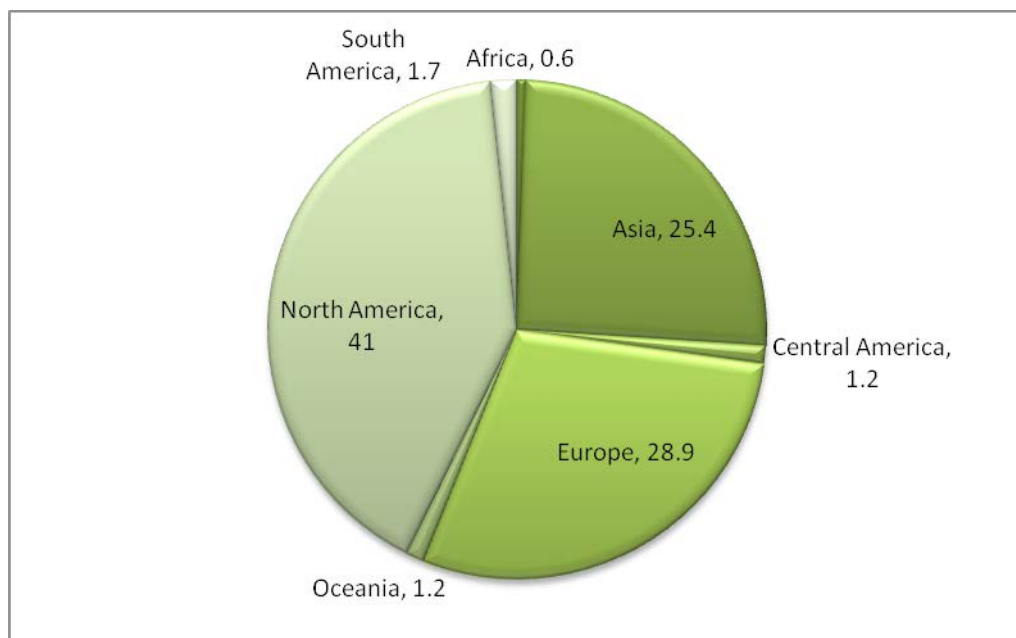

Figure 2.3: % Responses to the Survey categorised by continent

The responses were collected from over 20 different industry sectors with the biggest majority unsurprisingly from the manufacturing sector (29.5%). But the fact that such a range of sectors responded (Figure 2.4) demonstrates how the methodology has been accepted throughout industry. It is encouraging to see that LSS is filtering into the Government sector, a place where the reduction of waste and defects is not before time and also into such diverse sectors as entertainment and agriculture.

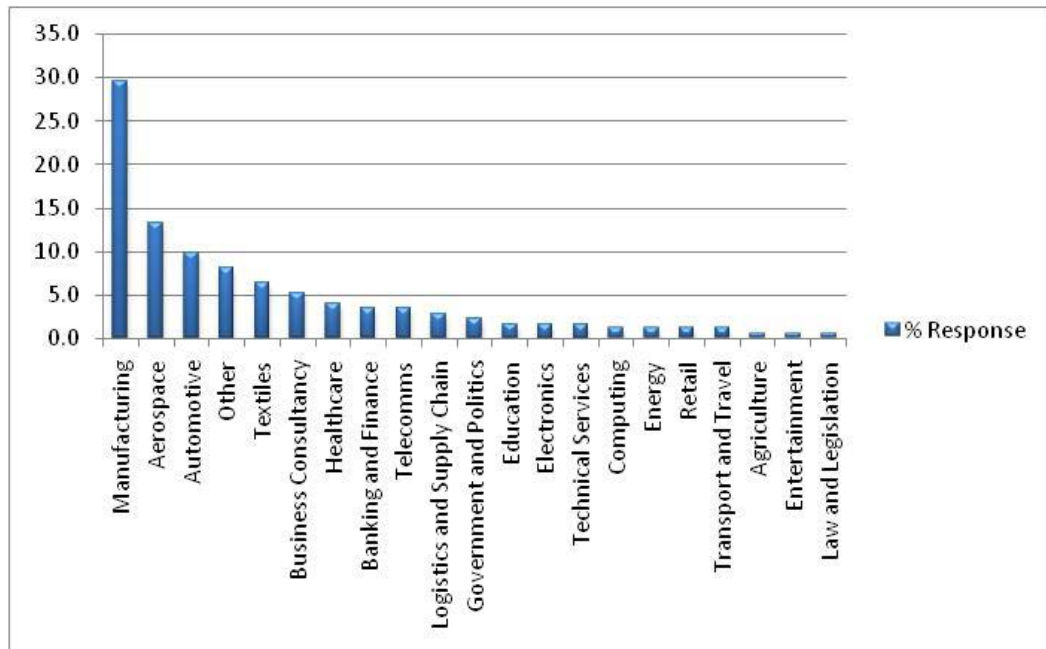

Figure 2.4: % Responses to the Survey by Industry Sector

Many practitioners still think that LSS is a production orientated approach. However, the survey responses showed that 14 different departmental functions use LSS (Figure 2.5). The largest response being from the quality function; however the results clearly show that it is also being used within IT, R&D and procurement. This spreading out to other departments or functions shows a growing cultural acceptance of LSS methodologies within global businesses.

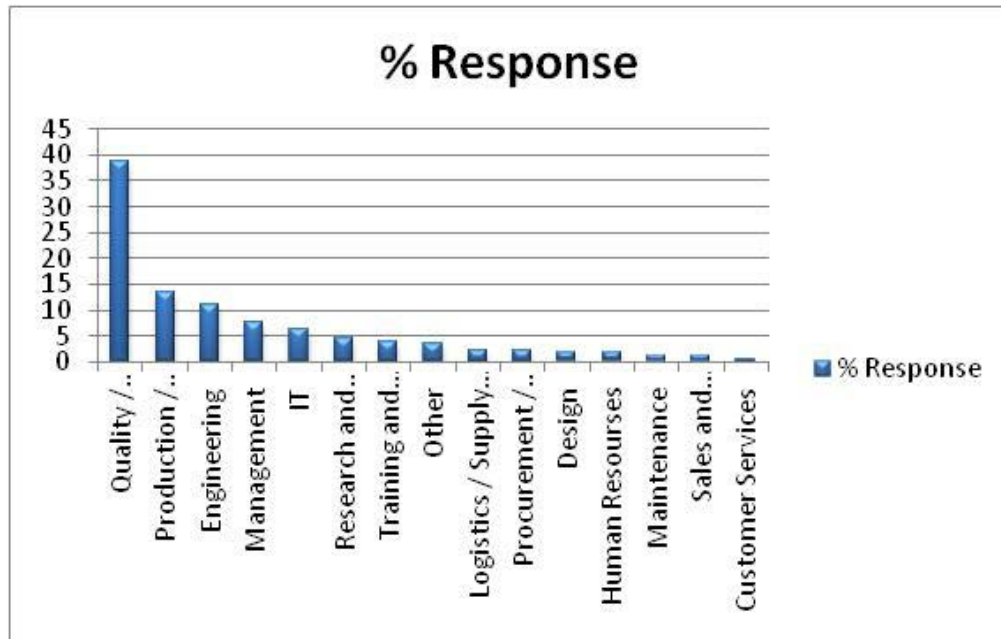

Figure 2.5: % Responses by Departmental Function

2.6 Key Opportunities and the Future

As we have clarified earlier in the paper LSS is not a static process and will continue to evolve. The purpose here is to discuss where this approach may be leading into the future. It is not an easy task to predict where it will lead, however there is evidence to suggest that changes are occurring in the LSS community and it is the objective of this paper to explore what these possibilities could be.

2.6.1 A Globally Recognised Lean Six Sigma Approach

When examining Lean and Six Sigma it is obvious that both have a structured approach. Lean has the 5 Lean Principles (Womack, et al 1996) and Six Sigma has DMAIC (Peter et al 2002). The approach for Lean Six Sigma however is much more of a grey issue. There is no globally recognised structured approach which integrates both Lean and Six Sigma together.

Implementing the Lean and Six Sigma approaches separately can cause confusion within the workforce; they question why they are implementing two separate “initiatives”? Also due to the similarities of some of the potential benefits this could cause conflicts to arise. Using the combined approaches that have been developed by consultants or internally within large organisations has the benefit of being more structured. But, they vary from one organisation to another both in the quality of the approach and the implementation process.

Therefore the future of LSS needs a recognised structured approach which combined the best of both Lean and Six Sigma. The question here though is how would this happen? This is a difficult question as it would take a large organisation with a huge influence to turn this into a reality. Because LSS is so recognised and already well into its lifecycle within industry, it could be possible that this step in its evolution will be missed out altogether.

2.6.2 Green Lean Sigma

One avenue in particular which LSS could evolve into could be Green Lean Sigma (GLS) or an environmental interpretation of LSS. This new and innovative methodology already exists in a variety of guises such as “Green Sigma” (Lyengar et al 2008) developed by IBM or Lean Environment toolkit (Reed et al 2007) developed by the Environmental Protection Agency (EPA) in the USA. Currently much of these new developments are coming from the environmental community rather than the LSS Community.

In practice LSS can, quite by chance, be environmentally friendly, however as it stands currently, it is widely implemented by organizations without considering the environment and the positive and/or negative impact that LSS can have. By reducing defects and variation organizations are already contributing to reducing their Carbon Footprint but many companies may not be aware of this fact.

Using principles of LSS tools such as 7 Wastes can play a big part in being a more environmentally sound organization whilst improving business performance at the same time, for example: -

Transportation – Reducing distances between processes which require mechanized trucks or handling systems will significantly reduce energy consumption.

Waiting times – Reduction/elimination of waiting times between processes using line balancing techniques will have a big impact on yearly emissions.

Defects – The use of tools such as SPC to reduce variation and therefore scrap or rework saves time, money, precious resources and lowers CO2.

Over production – Where products have a shelf life, such as the food sector, producing what the customer wants when they want it, reduces the waste in landfill sites.

The development of the GLS approach could however follow a similar path to LSS discussed previously in that many individual organisations (e.g. IBM, EPA, and Deloitte) are developing their own interpretations of what GLS should be. Without a large influential organisation developing this new approach (such as the way that Motorola or Toyota did with Six Sigma and Lean respectively) it may well splinter into different interpretations of what GLS should be.

Many new and exciting “Green” or environmental versions of classic LSS tools and techniques are now either in development or being used. Leading the way in this area are currently the likes of the EPA and IBM. It may be feasible to see tools such as Green 5S (Marsh and Perera 2009) which aim to increase sustainability of existing LSS tools become commonplace in the near future within organisations

Knowledge and awareness of Green Lean and/or Six Sigma is growing at quite a pace. Our research in the table 2.1 below has shown that a total of 30.3% of LSS Users has heard of variants of Green Lean Sigma.

Approach Type	% Response
Green Lean	15.4
Green Sigma	4.8
Green Lean Six Sigma	10.1
None of the above	64.9
Other	4.8

Table 2.1: Survey Response from Lean and/or Six Sigma Users on whether they are aware of Green or environmental versions of Lean and/or Six Sigma

2.6.3 Integrating Discrete Event Simulation with Value Stream Mapping

Results from our research have shown that 70.5% of the LSS community use value stream mapping (VSM). VSM is an excellent tool to clarify where wastes including excessive inventory, queues and defects lie in an organisation. One of its key downsides however is that it is a static map or snapshot at a point in time and does not capture the variability of a process. Therefore if VSM is conducted one week, then repeated the following week it could look completely different. This makes it difficult to make well judged data driven decisions and therefore you could say that VSM is not really a true LSS tool as these variations aren't taken into account which goes against the ethos of Six Sigma.

This however could change with the adoption of Discrete Event Simulation (DES) to create dynamic VSMs. This, if proven, would transform VSM into a true and worthy LSS tool. There is still some way to go before this can happen due to the sheer number of variables in typical manufacturing/service processes

Over the last decade there have been numerous attempts (Bayle et al 2001, Lian et al 2007) to integrate DES within LSS projects. These attempts demonstrated how DES could be used in LSS projects and used case studies to clarify how it could be used in Lean manufacturing however the successful integration to VSM still remains problematic at the moment.

2.6.4 Lean Six Sigma Software Advances

A revolution has occurred over the last 20 years regarding the use of software applications for Lean and Six Sigma projects and these are now particularly commonplace within the Six Sigma community in the form of statistical software such as Minitab and SPSS. Responses from our survey indicate that 44.5% of the LSS community uses a statistical software package for their projects

This revolution shows no sign of abating and continues to advance. Within the Six Sigma community Minitab is the market leader and the addition of products such as Quality Companion has widened the appeal and led to an increased focus on the whole DMAIC process including the softer areas as well as the hard data driven statistics.

There are numerous benefits to these software packages in particular the reduction in errors when conducting statistical calculation rather than conducting them manually. But software can also take away the ethos of Lean in particular if it not used in a team environment correctly. LSS depends on the visual controls to communicate to all relevant stakeholders of a project and if this is not managed correctly via the use of software, this can reduce its impact and success.

Future software design will see more user friendly graphic user interfaces (GUI) and many software companies are now developing and marketing LSS software with highly visual and interactive dashboard designs. With the ever decreasing costs of large touch screen LCD monitors; these will surely replace the traditional paper based LSS visual control boards in offices and shop-floor environments.

2.7 Paper Conclusions

From its early incarnations, LSS has developed and broadened its range of appeal both globally and by industry sector. Its ability to reduce costs, improve quality and reduce customer delivery time has sealed its place as a leading methodology for improvement of our businesses in the past, present and hopefully the future.

Specifically how it will evolve is difficult to surmise but it is hoped that some of the areas of discussion in this paper will develop and become embedded into making LSS sustainable in the coming decades. For this to happen however it is important that the original ethos of both Lean and Six Sigma remain and hopefully they will not become diluted or lost along the way.

What can be certain however are that improving technologies will continue to play an increasing part of the LSS evolution and topical issues such as environmental sustainability will drive forward business improvement approaches such as LSS.

2.8 References

Antony, J., & Escamilla JL 2003, Blending the Best of Lean Production and Six Sigma for Achieving and Maintaining Operational Excellence pp 5

Bayle, P., Farrington, M., Sharp, B., Hild, C., & Sanders, D 2001, 'Illustration of Six Sigma assistance on a design project', *Quality Engineering*, vol. 13, pp.341–349.

Lian, YH & Van, LH 2007, 'Analyzing the effects of Lean manufacturing using a value stream mapping-based simulation generator', *International Journal of Production Research*, vol.45, no.13, pp. 3037- 3058.

Lyengar, M 2008, Green Sigma - How to optimize your carbon management through Green Sigma pp1-2 http://www-05.ibm.com/ie/emerging_business_centre/pdf/Green_Sigma_final_Strategy.pdf 01/11/2009

McClellan, J 2004, *The Benefit of Using Simulation to Improve the Implementation of Lean Manufacturing – Case Study: Quick Changeovers to Allow Level Loading of the Assembly Line*, Master of Science Thesis, School of Technology, Brigham Young University.

Marsh, J., & Perera, T 2009, 'Conducting a Green 5S Sustainability Audit', *WCBF Green Sigma Conference* May 2009

Reed, C 2007, The Lean and Environment toolkit, pp 1-96 <http://www.epa.gov/lean/toolkit/>

Snyder, K & Peters, N 2004, 'Lean Six Sigma in the public sector: Applying proven methodologies to improve quality, remove waste, and uncover hidden opportunities in state and local government', *White Paper, Xerox Global Services Inc.*, September 2004.

Wiesenfelder, H 2009, Advantages and disadvantages of Six Sigma, eHow.com Feb. 05 2009 http://www.ehow.com/facts_4760705_advantages-disadvantages-six-sigma.html

Womack, JP & Jones, DT 1996, *Lean Thinking*, CPI, Great Britain, pp29-90.

Peter, SP., Robert, PN., & Roland RC 2002, *The Six Sigma Way*, The McGraw-Hill Companies, Inc., USA.

3 Lean Production implementation: case studies in Italian non repetitive companies

Alberto Portioli Staudacher and Marco Tantardini

Department of Management, Economics and Industrial Engineering,

Politecnico di Milano, Piazza Leonardo da Vinci 32,

20133 Milano, Italy.

Abstract

The main purpose of this paper is to deepen the knowledge of Lean implementation in non repetitive companies, and highlight differences with repetitive ones, focusing on a few key elements of Lean Production. Carrying out 9 case studies in Italian non repetitive companies, we have investigated how non repetitive companies identify flow (value stream), implement pull production, use takt time and care of quality and standardization. As well, the paper analyses how non repetitive companies push lean along supply chain and how they organize organizational structure. Results were then discussed with three non repetitive companies not participating to the case study activity. Results show that non repetitive companies face specific problems/difficulties in implementing lean principles and that these problems are related to certain characteristics of their production. These characteristics were highlighted. The paper underlines characteristics of non repetitive companies limiting the implementation of Lean production and poses the basis for future researches in this field.

Keywords: Lean manufacturing, case studies, Italian non repetitive companies

3.1 Introduction

European companies are facing the most important competitive challenge since the Second World War. It is well known that they can stay ahead of low cost countries' companies only through innovation. Large investments and attention are devoted to technology innovation, but this is not enough: organisational and managerial innovation is an additional lever that must be exploited. Most companies have 40-70 % of total activities carried out, which do not add value to the customer. These activities are waste, and competitive advantage can be achieved through waste reduction (Ohno 1988, Womack and Jones 1996).

Lean Production (LP) is the approach of the Toyota Production System that focuses on waste reduction to improve operations' performances, and gave quite interesting results in many implementations. That's why in recent years a lot of interest from companies and researchers has focused on Lean Production. Such interest has produced books and articles, case studies and reports that help in better understanding the new approach and the difficulties and expected advantages of its implementation.

Most of the existing literature, about Lean Production refers to companies producing and selling from a catalogue and with low customization degree. Much less is known about Lean experiences from companies which sell customised products (e.g. machine tools). In fact, there is some scepticism about the possibility to adopt Lean approach in such companies. But many European companies, and most Italian ones, compete on high customization, on their ability to accommodate customer wills, modifying their product accordingly. This requires to manage a huge variety of products, with Engineering to order operations. These companies are looking for new managerial and organizational models to strengthen their global competitiveness, and Lean can be the answer to their needs. We can name these companies “non repetitive” companies (White and Prybutok 2001). In order to satisfy their needs it is necessary to take the well structured Lean methodologies developed for repetitive companies and adapt them to the non repetitive environment. The first step in this direction is to understand the peculiarities of non repetitive production from the lean approach point of view.

Therefore, the aim of this paper is to better understand and highlight to what extent non repetitive companies have adopted Lean approach and have adapted Lean practices to their specific peculiarities. In particular, specific problems for non repetitive companies are pursued in order to better address our future research.

The reminder of the paper is organised as follows: in section 3.2 a brief literature review is presented mentioning the state of art of the investigations having to do with similar or related objectives; section 3.3 describes the case studies as the base of the research. Section 3.4 presents main results of the case studies with an interpretation and a comment. Finally, conclusions and future developments are presented in section 3.5.

3.2 Literature review and research objectives

Over the last decade a number of investigations on Lean Production have been proposed. The ones most related to this research work are briefly presented next, in chronological order, highlighting their scope and objectives. Sohal and Egglestone (1994) present a telephone survey of 42 Lean implementers, where they investigate to what extent LP has been implemented in Australian organizations. The sample includes companies from various industries and both repetitive and non repetitive companies. The authors also seek to identify the benefits from LP implementation, and investigate the structural changes taking place as a result in the implementation. Finally they present future trends in Lean production, but do not compare repetitive and non repetitive companies.

Panizzolo (1998) presents 27 interviews to Lean implementers, from a list of Italian “excellent” manufacturers, with the main scope to understand how much firms are doing on various Lean improvement programmes and to understand which are the most used and applicable. Even if not clearly specified, in the sample probably some are repetitive and other are non repetitive companies. However no distinct analysis is provided for the two type of companies.

White et al. (1999) investigate LP implementation differences between a set of 174 U.S. small manufacturers (with less than 250 employees) and one of 280 U.S. large manufacturers (with more than 1000 employees) in order to understand to what extent LP techniques have been implemented, and the relationships between implementation status of 10 specific LP management practices and associated changes in performance in the two groups of manufacturer. Companies come from the USA AME (Association for manufacturing excellence). No specification is provided about how many companies are repetitive companies and how many are non repetitive companies and no comparison is made between the two type of firms.

Interviewing 14 companies and deepening 3-case studies, Lewis (2000) investigates the impact of LP implementation on overall competitive position of the company and overall business performances after Lean implementation. The paper argues that lean production can underpin competitive advantage if the firm is able to appropriate the productivity savings it creates. There is no indication on the proportion of repetitive and non repetitive companies in the sample, and the author does not explicitly address the difference between repetitive and non repetitive companies.

White and Prybutok (2001) investigate the intensity and presence of the relationship between JIT/Lean techniques level of implementation and the production system characteristics (non repetitive productions – repetitive productions). Data analyzed come from the Association for Manufacturing Excellence and refer to USA companies. Out of the 494 companies surveyed, 191 are non repetitive productions companies. 303 are repetitive productions companies.

Comparing results from repetitive and non repetitive USA manufacturers, main objectives of the study are the understanding of key benefits from Lean Production implementation, and the search for a possible relationship between being a repetitive – or non repetitive – company, and the use of different LP techniques. The paper also investigates whether the level of benefits achieved directly depends on the implementation level of the LP techniques and whether there is a difference for repetitive and non repetitive companies.

In their work, Shah and Ward (2003) try to understand, in a total of 1757 respondents coming from a vast range of industries, how firm size, age and unionization degree affect effort needed for Lean implementation and necessary effort in achieving improvements. No segmentation between repetitive or non repetitive companies is done. Companies surveyed have in common the adoption of at least one LP technique. Research goal is also to understand if Lean bundles implementation has positive effects on operative performances. Authors use Total Productive Maintenance (TPM), Human Resources Management (HRM), Just in Time (JIT) and Total Quality Management (TQM) as estimators of LP implementation. At the end of the article, differences between discrete production and process productions are analyzed too.

56 Egyptian LP implementers and 38 Egyptian firms considering LP implementation, coming from a vast range of industries, are considered by Salaheldin (2005) to delineate the major human modifications to be undertaken prior to LP implementation in Egyptian manufacturing firms. The author discerns benefits obtained from Lean Production implementation, identifies the problems that Egyptian manufacturing companies typically encounter in implementing Lean philosophy, and explores the relationship between human modifications efforts to be undertaken prior to Lean implementation and Lean success. Companies surveyed come from a wide range of industries. Lean Implementers (LI) and Non Lean Implementers (NLI) are analyzed. Even if the author considers how the sample is composed between repetitive and non repetitive companies, no specific analysis is provided comparing the two type of companies. The only statement provided is that JIT/Lean programs seem to be more suited to more repetitive production with steady demand, as stated also by Moras and Dieck (1992) and Vuppapapati et al. (1995).

Achanga et al. (2006) propose the critical factors that constitute a successful implementation of LP within manufacturing SMEs. No indications about production characteristics (repetitive / non repetitive) of these companies are provided. A combination of comprehensive literature review and visits to 10 SMEs based in the East of the UK were employed in the study. Companies practices were observed to highlight the degree of LP implementation within these companies. Then LP critical factors determining a successful Lean implementation within SMEs environment are captured and the authors provide SMEs with indicators and guidelines for a successful implementation of Lean principles.

Bonavia & Marin (2006) provide a view of the ceramic tile industry in Spain, mostly characterized by repetitive companies. In particular, main objective of the 76 visits to companies was to assess the extent to which the ceramic tile industry in Spain uses LP practices. In addition, effects that the most relevant Lean Production practices have on operational performances are investigated objectives too. To reach the goals, they try to investigate which are the most used LP practices in this sector, if larger firms have installed LP practices to a higher degree than smaller ones and if companies that adopt a LP practice to a greater extent obtain better results in terms of quality, productivity, lead time or stocks.

Portioli Staudacher and Tantardini (2008) investigate the differences between repetitive and non repetitive companies through a survey with 200 companies. A conceptual paper by Storch and Lim (1999) focuses on the shipbuilding industry to show how the uniform and continuous flow can be achieved in a typical build to order sector. Authors address how the use of Group Technology, of a well designed product work breakdown structure in order to create uniform and constant work contents at each manufacturing level, and process lanes, can result in a Lean flow. Rother (2002) provides hints on the pitch and workload releases in Make to Order companies. The author also suggests the use of first-in first-out (FIFO) lanes in order to create a flow in such companies.

Out of the literature analyzed, vast majority of Lean authors compare small and big companies, or deepen knowledge of specific industries. Only very few papers distinguish repetitive and non repetitive companies, and try to assess differences between the two type of companies. Even one of the main sources of literature on Lean, the Lean Enterprise Institute, is extremely focused on repetitive companies.

As generalized by Womack et al.(1990) and Shingo (1981), evidences provided by White and Prybutok (2001) and Soriano-Meier and Forrester (2002) show that LP can be successfully applied and results in better performances in non repetitive environments too. A few papers (Salaheldin 2005, Moras and Dieck 1992, Vuppalati et al. 1995) state that JIT/Lean programs seem to be more suitable for more repetitive companies with steady demands. At the same time, White and Prybutok (2001) state that repetitive production systems appear to be more progressive in their utilization of JIT/Lean practices than non repetitive production systems and that results suggest that non repetitive production systems are less likely to implement Lean than repetitive production systems.

Therefore, the objective of this paper is to deepen the knowledge of Lean implementation in non repetitive companies, and highlight differences with repetitive ones. In particular we focused on a few key element of lean:

The identification of a flow (value stream) and how this is highlighted in the plant (e.g. what kind of layout);

Pull production (if possible only one scheduling point);

The use of takt time (or is it only a computation with no reflection on hour by hour production?)

Care for quality and standardization;

Extension of Lean production along the supply chain;

Organizational structure of lean journey.

3.3 Research model and methodology

Our research project is composed of a survey, in order to address differences between repetitive and non repetitive companies, and several case studies. Case studies were developed to deepen problems and evidences emerged in the survey results and to deepen the knowledge about Lean implementations in non repetitive companies. Results and description of the survey are provided in another paper (Portioli Staudacher and Tantardini, 2008). This paper only presents evidences from the case studies carried out within 9 non repetitive companies.

All the companies investigated in depth come from the 32 non repetitive companies surveyed. All the companies analyzed are located in the north of Italy and basically they are Italian Engineer to Order / Make to Order companies that come from a wide range of industries (from the aerospace to the electrical industry, from electronics to CNC machines building). They produce products with a certain degree of customization based on customer order.

Out of these companies, two of them are big companies (more than 1000 employees). Other companies all count a number of employees between 100 and 500. The realities considered also differ in LP implementation maturity. Just one company have been implementing Lean for more than 5 years; 2 of them for a period between 3 and 5 years; 3 for a period between 1 and 3 years and 3 for less than 1 year. Companies were all visited performing on extensive plant tour, and interviews were carried out with Operations managers.

Interviews to Operation managers aimed to address the lean implementation pattern, the adoption of the Lean principles within non repetitive companies (in terms of flow, pull production, takt time and zero defects), the relationship with suppliers, the Lean practices on the overall supply chain and the organizational structure backing up the Lean project.

Plant visit allowed us to assess at what extent each company was implementing Lean techniques and at what extent Lean principles were adopted. Interviews allowed us to better understand what non repetitive companies are doing in their Lean implementation and what are main specific problems within these companies. Since the limits in the sample dimension, evidences from case studies were compared to evidences from the survey and discussed, in order to have some validation of the results. Final results were then discussed with three non repetitive Lean implementers not participating to the survey and case study activity. This resulted in a further validation and hints for future research.

3.4 Case Studies empirical results

Non repetitive companies investigated have started their Lean journey to strengthen their competitive position after a worsening in the overall competition. Consistently with repetitive companies, non repetitive companies state different sources for the Lean implementation. Some company start implementing Lean in response to the push of their customers. Other companies are forced by guidelines or medium-long term strategies coming from the holding or the headquarter. In other companies the push to Lean came from the change in the top management. Whatever the trigger, all the companies investigated started their Lean journey from the shop floor.

As managers state, in the shop floor muda is evident to everybody. That makes it easier to be eliminated because it is easier to have people focused on very tangible problems. This is particularly true when Lean is something new within the company and when people is not really convinced or trained on the new approach. The vast literature and experiences reported on the shop floor, and the fact that problems here are evident to everybody, makes easier to start from the production level. On the other hand, improvements on the shop floor level are evident to everybody and have a direct impact on the performances to the customer, in terms of time (lead time, lead time reliability), costs and quality.

3.4.1 Flow

The first point we wanted to investigate is how non repetitive companies identify flow, and arrange production accordingly. As far as we have seen, there is not a precise rule to choose the product family to map first. Some companies started from their most important one, others from the newest one. Other companies from the less strategic product as a pilot, in order not to affect too much overall results. All the companies investigated arranged the final assembly stage in product family streams, but only 3 companies, out of 9, drove the layout modification through the machining stage.

Companies that drove the layout modification through the machining stage arranged the layout in order to clearly separate the product families. The first company, producing CNC work centers, divided the machining job shop in two parts. The first one is dedicated to their Big Machines (i.e. those with approximately 150 KW engines). The second one is dedicated to their Small Machines (i.e. those with approximately 40 KW engines). The second company, producing for the aerospace industry, is a very mature Lean company. It had organized its machining layout in customer related product families.

The third company, set up an independent factory shed to install all the machines necessary to produce all the components and parts to the specific product family. All the others companies didn't push the layout modification to the machining stage for a couple of reasons. First of all, we have recorded that the push to a product family organization at the machining stage could be quite critic because the change from job shop configuration to a product family organization, is often a dramatic and radical change for companies.

In particular, the main concern is related to the variation in customer demand dedicating the machines to product families makes it more vulnerable to changes in volume of each family, which is quite common in these industries. The problem in the stability of the demand is a known problem in the non repetitive companies. In particular, Hendry and Kingsman (1989) and Kingsman and Mercer (1997) state that non repetitive companies commonly face a quite variable demand. Hicks and Braiden (2000) state that, in non repetitive companies, demand on the production resources is very variable over time, in terms of work levels and mix. In non repetitive companies there is high variability in the resources utilization over time and it's difficult to reach a balance in the production for the very dynamic nature of the constraints.

Product family organization at machining stage within non repetitive companies is then more critical because it may result in investments in resources (machine duplication, new production areas creation) and resistances from the management. Over the long run this can be overcome by investing in smaller and cheaper machines.

3.4.2 Pull production

The second aspect we wanted to investigate is how non repetitive companies implement pull. Concurrent to the layout re-organization activity, all the companies investigated state they have put in field some kind of activities like 5S and Visual factory. All the companies have also identified and carried out a set of indicators to monitor lean improvements. Even if all the companies state these techniques in field, there is a strong difference in the extent to which various companies have implemented them. Some seem to be mature in the various techniques implementation. Others have just began or just done something in a very localized area of the plant.

In particular, at this stage we were interested in better understanding pull production within non repetitive companies, since in a previous survey (Portioli Staudacher and Tantardini, 2007) a 72% of non repetitive companies stated they were using internal kanban in their processes. When asking managers about pull production and kanban implementation, misunderstandings emerged. In particular, with kanban we mean a pull system controlled via kanban, where upstream production is pulled from downstream consumptions.

As we have seen some company tend to use terms like supermarket, or pull production to just indicate a decoupling buffer (usually between machining stage and assembly stage) where assembly picks up material and machining puts down material. This decoupling buffer however, doesn't link assembly with machining. In particular, machining stage produces with its production plan, and assembly stage with its. Plans are created via MRP based systems and FIFO rules between fabrication and assembly are not generally pursued.

Visiting the companies of the case studies, we can conclude that no real pull production was in place within the main product value stream. As well, the use of FIFO lanes was not observed. On the other hand, some company implement pull production with kanban for the manufacturing of some components, high volume and common for all the product family.

Common to all the companies is the fact that managers state as very difficult to implement pull production in their environment, where end items are very customized and where customization can start at the very beginning of the fabrication stage. As a conclusion, we found out that pull production is generally not applied in non repetitive companies analyzed. In particular, where pull production was seen, was about a limited number of items, of very repetitive and stable demand. The managers interviewed do not have specific tools to figure out how to implement pull production to their environments, where products can be very customized, demand not predictable and where work contents between different products might be very different.

The last point also highlights the important problem of the difficulty in these companies to level production. Uniform workloads seem to be a problem in non repetitive companies surveyed by White and Prybutok (2001) as well, since this practice had been the least implemented.

3.4.3 Takt time production

The analysis carried out at this stage involves the understanding of how companies control production. First of all, we divide between companies that have explicitly calculated their takt time and companies that have not. We found out that 3 companies out of 9 have explicitly calculated their takt time. All these companies share similar characteristics. They have products that are quite similar in terms of time content on various resources and their product family demand volume is quite stable. Moreover, the time content of the final product in these companies is not very high. Companies that have not calculated the takt time present different motivations.

Some companies are not very familiar with takt time. They have not calculated the takt time because they don't know what it is. Other companies address the difficulty to calculate the takt time because of their company characteristics. In particular, all companies addressing the difficulty to calculate takt time present some of the following characteristics: they do not have stable demand in terms of product family demand volume, their products are completely different or their products' time contents are very different. Also, these companies can show products with a long lead time. As a fact, production control seen within non repetitive Lean companies can be substantially classified in two different clusters.

Time intervals control- This kind of control can be performed in different ways. First of all, companies can control production or resources (generally operators). Companies controlling production levels can base their controls both via takt time and via production plan. In the first case, companies explicitly calculate takt time. These companies address production control via takt time to assembly stage only. Control is not performed every takt time, with Andon devices. Instead production control is performed only every some time intervals (0,5 shifts – 1 production day).

In the second case, the logic is the same, but actual production levels are compared with production plan levels. Companies controlling resources generally face products with a long internal lead time, where product can be worked on a single resource for a long time period or face very low demand volumes. In these companies, there is a product work breakdown structure to identify and timing all the necessary activities. In such companies activities that the resource has provided on the product in a time period can be compared with those planned in that time interval. This can give a feedback about product lateness in respect to due dates.

Final balance control- Once the resource has completed working on the product, the resource register it. The information system records this data and can give, as an output, a feedback about product lateness or advance. This feedback is provided comparing actual production end date with the planned one. This control was seen in two companies where products are very different, demand volumes are variable and products have long cycle times.

We found out that, apart from some misunderstanding and a not complete and full use of takt time in controlling production, interesting hints came out when considering takt time production within non repetitive companies. In particular, we found out that problems in applying takt time occur when:

- Products have a long cycle time on production stages or product demand volumes are very low (this can be a problem because takt time is a product related measure and the better it works as a control device, the more frequent is the control performed)

- Family products are not comparable, both because have different cycle times, and are composed by a different number of the same components / subassemblies. This does not lead to a representative measure of the takt time.

3.4.4 Zero defects procedures and standard activities

The institution of zero defects procedures and standard activities within Lean companies is fundamental in order to reduce variability and variance. Consistently with the rest of the paper, we want to highlight main problems non repetitive companies seem to find out on these specific topics. Non repetitive companies characteristics do not seem to strongly impact on zero defects and procedures used. It seems that the use of procedures (for changeovers, maintenance, production activities) is not related to level of customization or demand stability or some other specific characteristic of non repetitive companies. Instead, the use of procedures or standard activities seems to be more related to other factors, such as industry, lean maturity degree, and managers' ability of the managers to convince the highly skilled workers to introduce standards in their working activity. In fact, highly skilled workers, generally do not like very much to standardize their working activities.

In particular, we found out that two companies, differing very much in the years of implementation, have in place very advanced zero defects procedures. They both work in the aerospace industry, characterized by very strict quality certification standards. Within limitations in our sample size, we can only conclude that non repetitive companies characteristics do not seem to impact on zero defects procedures and standard activities.

Good examples of standard activities within non repetitive companies and of waste removal activities were provided in administrative areas. This led companies investigated, that exploited this way, to huge savings. Standardization and zero defects procedures are effectively applied in administrative areas, especially in the product configuration/product development value stream from order configuration by sales managers to product design phase. Other area sometimes involved in Lean interventions is production planning.

3.4.5 Extension of Lean practices along the Supply chain

After several shop floor interventions, non repetitive companies investigated have tried to push Lean approach through their suppliers. This is in order to have a better synchronization with them, and to reduce raw material stock levels. In our survey (Portioli Staudacher and Tantardini 2008) we found out that a vast majority of companies surveyed stated to have extended Lean practices through their suppliers. As well, they stated to have in place JIT deliveries from suppliers. Several companies investigated in case studies activity stated the same. We wanted to deepen more JIT deliveries with our sample, since Panizzolo (1998) argues that, within its excellent companies' sample, main difficulties were addressed to suppliers-related practices.

First of all, it's to say that all companies state they have modified and strengthened relationships with suppliers since Lean adoption. Projects and activities carried out support the statement. However, when asked about JIT deliveries from suppliers, some problems emerged. When analyzing relationships with suppliers we can distinguish 4 different ways to make orders to suppliers. The first one is the classical approach based on the economic order quantity. Others use kanban, in different ways.

Economic order quantity approach: company typically makes a yearly forecast of quantities, with periodical reviews and sends it to its supplier. The supplier deliver what requested, trying to match the due dates and generally in quite big batches.

Transfer kanban approach: company makes a yearly delivery plan that sends to its supplier. Supplier have to deliver what asked by the customer, in the exact quantity and when asked by the kanban sent by the customer.

Transfer kanban and production kanban approach: This is the transfer kanban approach described above with the supplier using production kanban to replenish its finished-good inventories.

Levelled pull: This is the pure Lean approach for supply chain, as described by Liker and Wu (2000). Customer do not need to provide a detailed delivery plan, they only communicate their suppliers demand volume levels.

Customers level orders in the time and frequently order products in small batches. Supplier replenish finished goods inventory using production kanban. This is the so called JIT delivery. Suppliers and customers can work with a minimum level of stocks. Out of the companies investigated some misunderstanding of JIT deliveries emerged. In fact, many companies relate the introduction of Lean practices to a closer relationship with suppliers in terms of wider transparency on production plans and not in the sharing of a common method, as Lean would imply.

Out of these companies, Lean interventions in supply chain management generally implied a shift from the economic order quantity approach to the transfer kanban approach (with or without production kanban) for a few important suppliers. No leveled pull approach or Lean Supply chain approach was seen. We also found out that companies generally do not care about suppliers (i.e. they do not know whether suppliers build up huge amounts of finished goods inventories to respond quickly to customers kanban or they really use production kanbans). However this is not the Lean approach and the advantage here is generally only for customers. Consistently with Panizzolo (1998) we state that, even overcoming some misunderstanding about JIT deliveries, the introduction of advanced practices in supplier management seems to be quite difficult to attain in short times.

3.4.6 Lean organizational structure

Consistently with White et al. (1999) and Shah and Ward (2003), in a previous survey (Portioli Staudacher and Tantardini 2008) we concluded that large companies are more likely to implement lean practices than smaller companies and have better chances to achieve large improvements. However, no strong evidences were found of a relationship between company size and degree of improvement.

We stated that there is correlation between results achieved and the Lean organization backing up improvements and activities. Here we want to better investigate Lean organizational structure and its impact on the performances achieved. Out of the companies analyzed, and consistently with our survey results, we have found two different approaches to carry out the Lean journey.

The first one is “structured approach”, with a well organized structure since the very initial stages of the Lean journey. In this situation, roles are well defined, and responsibilities are well distributed among people. The second one is “vague approach”. In this case, the Lean journey is strongly driven by a highly committed sponsor (usually Operation Manager), with sometimes few other people backing up the sponsor, but with no formal responsibilities.

In this situation, the sponsor builds up temporary kaizen teams, in specific localized areas where improvements are necessary. Temporary kaizen teams generally involve people from the shop floor, working in that area. When necessary, some people from maintenance or quality control are involved. Once the improvement is reached, the team is released. Once the improvement is reached, performance indicators are identified to monitor improvement. Monitoring is provided by operators. In this situation, sponsor arrange meetings at regular time intervals, with operators from different areas, in order to prioritize improvement actions for future, asking operators main problems.

Out of the companies investigated, 3 set-up a well organized Lean structure since the very initial stages of the Lean journey. In the mentioned survey, 63% of total non repetitive respondents adopted a “structured approach”.

Results from the survey highlight that companies stating with a “structured approach” record better improvement levels (2,9 on a scale from 0=no results to 5 = excellent results) if compared to companies with a vague approach (stating an average improvement level of 2,4 on a scale from 0=no improvements to 5=excellent improvements). Figure 3.1 presents, for each of the performances monitored, a comparison between average improvements stated by companies with “structured approach” – compared with companies with a “vague approach”.

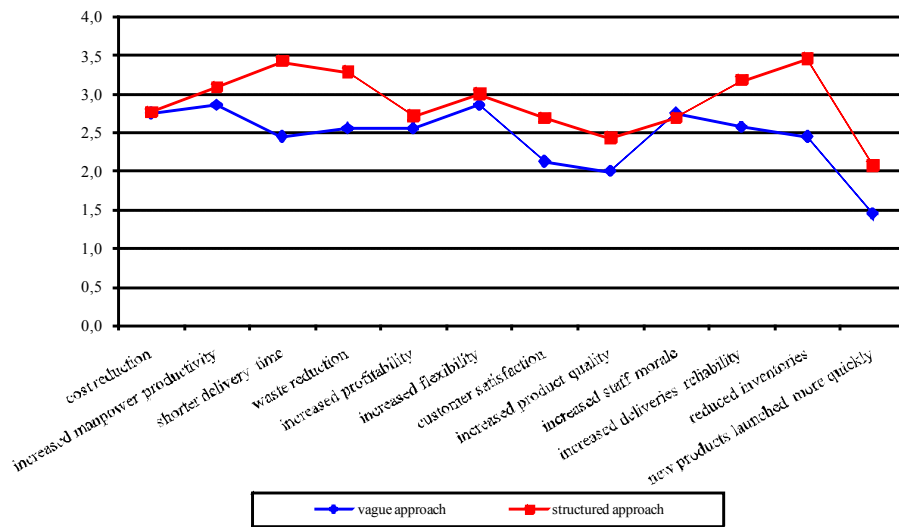

Figure 3.1: Average results on the performances monitored between highly organized Lean structures and less organized Lean structures

Then, the more the Lean team is structured, embracing different people from different offices and people coming from different levels with clear responsibilities, the better improvements are. We have also found that the type of organizational structure backing up the Lean project doesn't seem to be dynamic. In particular, it seems that once the company has established the type of its organizational structure, it's infrequent to change.

3.5 Conclusions and future developments

Our research aimed to understand main problems limiting non repetitive companies in implementing Lean approach. To this extent we analyzed in depth 9 different companies via case studies. Results show that non repetitive companies face specific problems/difficulties in implementing lean principles and that these problems are related to certain characteristics of their production. It is therefore necessary to deepen the knowledge of such characteristics and to develop new knowledge in how to implement lean to a full extent in non repetitive companies.

Limits of our research are clearly related to the sample size investigated. However, we do not think that sample size has prevented the upcoming of some important characteristic of non repetitive companies resulting a problem to Lean implementation. Table 3.1 below reports, for main characteristics of non repetitive companies, the impact on the Lean methodologies/ practices analyzed.

Non repetitive company characteristics	Flow	Pull production	Takt time	Production leveling
Many product families / products highly customized. Products in the same family require different routings				
Unstable demand volume for product family				
Unpredictable demand				
Products have different work and material content				
Products with high work contents				

Table 3.1: Characteristics creating difficulties for Lean principles.

3.6 References

Achanga, P., Shehab, E., Roy, R., & Nelder, G 2006, 'Critical success factors for Lean implementation within SMEs', *Journal of Manufacturing Technology Management*, vol. 17, no. 4, pp. 460-471.

Bonavia, T., & Marin, JA 2006, 'An Empirical study of lean production in the ceramic tile industry in Spain', *International Journal of Operations & Production Management*, vol. 26, no.5, pp. 505-531.

Hendry, LC., & Kingsam, BG 1989, 'Production planning systems and their applicability to make to order companies', *European Journal of Operations Research*, vol.40, pp.1-15.

Hicks, C., & Braiden, PM 2000, 'Computer – aided production management issues in the engineer-to-order production of complex capital goods explored using a simulation approach', *International Journal of Production Research*, vol.38, no.18, pp.4783-4810.

Kingsman, BG., & Mercer, A 1997, 'Strike rate matrices for integrating marketing and production during the tendering process in Make-to-order subcontractors', *International Transaction Operational Research*, vol.4. no.1, pp.251-257.

- Liker, JK., & Wu, YC 2000, 'Japanese Automakers, U.S. Suppliers and Supply Chain superiority', *MIT Sloan Management Review*, Fall 2000, vol. 42, no. 1, pp. 81-93
- Lewis, MA 2000, 'Lean Production and sustainable competitive advantage', *International Journal of Operations & Production Management*, vol. 20, no. 8, pp. 959-978.
- Moras, R., & Dieck, A., 1992, 'Industrial application of Just in Time: lessons to be learned', *Production and Inventory Management Journal*, vol. 33, pp. 25-29.
- Ohno, T 1988, *Toyota production system: beyond large-scale production*, Productivity Press.
- Panizzolo, R 1998, 'Applying the lessons learned from 27 lean manufacturers. The relevance of relationship management', *International Journal of Production Economics*, vol. 55, pp. 223-240.
- Portioli Staudacher, A., & Tantardini, M 2007, 'Lean Production Implementation – a survey in Italy', *Proceedings of the CIO 2007*, Madrid.
- Portioli Staudacher, A., & Tantardini, M 2008, 'Lean Production Implementation: a comparison between repetitive and non repetitive companies', *Proceedings of the 15 International working Seminar on Production Economics*, Innsbruck.
- Rother, M 2002, 'Value Stream Mapping in a Make to Order environment', Lean Enterprise Institute. <http://www.lean.org>
- Salaheldin, SI 2005, 'JIT implementation in Egyptian manufacturing firms: some empirical evidence', *International Journal of Operations & Production Management*, vol. 25, no. 4, pp. 354-370.
- Shah, R. & Ward, PT 2003, 'Lean manufacturing: context, practice bundles, and performance', *Journal of Operations Management*, vol. 21, pp. 129-149.
- Shingo, S 1981, *Study of Toyota Production System from industrial engineering viewpoint*, Tokyo: Japan Management Association.
- Sohal, AS. & Egglestone, A 1994, 'Lean Production: Experience among Australian Organization', *International Journal of Productivity and Performance Management*, vol. 21, pp. 129-149.
- Soriano-Meier, H., & Forrester, PL 2002, 'A model for evaluating the degree of leanness of manufacturing firms', *Integrated Manufacturing Systems*, vol.13, no.2, pp. 104-109.
- Storch, RL., & Lim, S 1999, 'Improving flow to achieve lean manufacturing in shipbuilding', *Production Planning and Control*, vol.10, no.2, pp.127-137.
- Vuppapapati, K., Ahire, S., & Gupta, T 1995, 'JIT and TQM: a case for joint implementation', *International Journal of Operations & Production Management*, vol. 15, no. 5, pp. 84-94.

White, RE., Pearson, JN., & Wilson, JR 1999, 'JIT Manufacturing: a survey of implementations in Small and Large U.S. Manufacturers', *Management Science*, vol. 45, no. 1, pp. 1-15.

White, RE., & Prybutok, V 2001, 'The relationship between JIT practices and type of production system', *Omega*, vol. 29, pp. 113-124.

Womack, JP., & Jones, DT 1996, *Lean thinking*. Free Press.

Womack, JP., Jones, DT., & Roos, J 1990, *The machine that changed the world*, Macmillan, New York, NY.

Wu, YC 2003, 'Lean manufacturing: a perspective of lean suppliers', *International Journal of Operations & Production Management*, vol. 23, no. 11, pp.1349-1376.

4 Development of a 5S Sustainability Model for use with Lean and/or Six Sigma projects

James Marsh

Sheffield Hallam University and SD & S Consulting Ltd., Howard Street,

Sheffield S1 1WB, UK

Email: jamarsh8@my.shu.ac.uk

Abstract

Many thousands of companies throughout the world implement Lean and/or Six Sigma with varying degrees of success. Of the companies that have used these proven approaches, 77% of Lean and 76% of Six Sigma implementations fail. Of the tools and techniques most commonly used in the early stages of improvement deployments, 5S and Value stream mapping are identified. Research has shown that 5S provides quick improvements within many organisations but they find it difficult to sustain this improvement over time particularly when they reach the 4th phase of the approach. Once the low hanging fruit has been reaped, the motivation often reduces and the improvement programme can fail.

A 5S sustainability model using the DMAIC approach would provide a means of measuring the level of achievement within various functions of an organisation across each phase of the 5S program. The model would consist of an audit process designed around the 5S toolset aimed at all levels of the organisation. This would provide an insight into the culture of the organisation and a general operational health-check of the 5S process in place at the company. The data from the audit would subsequently be analysed via a specially developed model and the resulting recommendations implemented to improve the overall “buy in” of the process. It is proposed to conduct this methodology in a Lean “automated” manner reducing the need for time consuming methods for collecting, measuring and analysing the data.

This paper details the strategy and development thus far of the sustainability “proof of concept” model and the next steps required to meet the needs of selected companies, with the future aim to benchmark this process within other sectors before full role out to industry.

Key Words: 5S, Sustainability, Six Sigma, Lean, Audit, Assessment

4.1 Introduction

Both Lean and/or Six Sigma approaches have been in existence for many years and prove to be ever popular in Industry however the success associated with these tools and techniques remains low. Of the companies that have used these proven approaches, 77% of Lean and 76% of Six Sigma implementations fail (Mehta 2004) to achieve the benefits associated with these approaches. Of the tools and techniques most commonly used in the early stages of improvement deployments, 5S, 7 Wastes and Value stream mapping are identified.

Much research has been conducted examining the reasons for failure of Lean and Six Sigma approaches (Peterka 2005, Flinchbaugh 2006, Carnell 2008), the popular theories include cultural readiness, management commitment, inadequate training/education and dilution of the core approaches amongst others. However what is clear is that each organisation is unique and there is not one single solution to solve the problems of providing continuous sustainability. Therefore it would be useful to provide a method of assessment so that the issues preventing sustainability can be identified and worked on to improve the probability of success.

This paper examines one of the most popular tools used during the early phases of Lean and/or Sigma implementations. 5S is extremely widespread and is very useful for gathering the low hanging fruit and gaining momentum for success however for many organisations this success is short lived and is not sustained.

The aim of the paper is not to identify why 5S fails in general terms but to develop an audit tool which can be used by companies who currently use 5S. The reason for this is that each 5S implementation is different and the causes for failure and lack of sustainability also vary. Therefore it is deemed of value to be able to assess a company's implementation and clarify the causes for failure as well as opportunities for improvement.

4.2 Market Need

The need for the 5S Sustainability tool was borne from both a client need and personal experience of ineffective Lean Six Sigma assessment processes over the previous ten years. The short term strategy is to therefore develop and optimise the proposed 5S sustainability model and to broaden this out in the long term to a Lean Six Sigma sustainability assessment process.

It is envisaged that the 5S audit tool will help facilitate the success of Six Sigma by providing companies with an insight as to what exactly is preventing the 5S process from being sustainable within the workplace. These specific causes once clarified can then be acted upon using a suitable continuous improvement planning process with key stakeholders from the project.

The client, a leading producer of industrial chemicals in their current state has a 5S audit tool based around a series of questions formulated on an EXCEL spreadsheet. This type of method is commonly used within industry and this process suffered several disadvantages these included:

- Time consuming task
- In effective metrics
- No feedback process
- No defect control

4.2.1 Key Customer Requirements

Taking into account the current limitations of the existing process the following key customer requirements were clarified with the client for the revised 5S Audit to meet:

- Development of a 5S Audit assessment questionnaire which can be easily modified
- Delivery of 5S Audit to stakeholders via email or hosted on a web page.
- Automatic submission of 5S Audit once complete
- Capability to generate a variety tables and charts for analysis
- Capability to generate statistical outputs
- Use of results to generate constructive conclusions and recommendations
- All the above to be provided using within a single software application

4.3 Software Application Evaluation

A market survey was undertaken to find a package capable of delivering the requirements. 5 different applications analyzed and evaluated against a selection criteria matrix. Analysis of this is depicted in figure 4.1.

Selection Criteria	Application				
	Excel	Survey Monkey	SNAP 9	Survey Methods	Nvivo
Questionnaire Function	0	6	8	9	6
Distribution of Questionnaire	0	8	7	9	4
Collection of data	2	8	9	9	4
Compatibility	5	5	8	8	5
Ease of use	2	9	7	8	3
Analysis	5	3	8	3	3
Charts and tables	5	4	8	4	4
Distribution of Analysis	3	2	8	5	3
Cost	10	9	5	8	5
Support	7	3	8	5	7
Training	1	1	8	2	8
Credibility	6	3	8	7	7
Mobility	9	2	8	3	5
Flexibility	7	3	8	7	4
Future proofing	5	2	7	4	7
Total	67	68	115	91	75

Figure 4.1: Evaluation of Software applications for 5S Audit

From the evaluation, Snap Survey was the only package deemed to meet the customer and technical requirements to the necessary levels to deliver a 5S Assessment process. The application had the ability to build audits quickly and easily, which many of the other packages could also deliver apart from EXCEL. However when combined with its ability to produce a wide range of graphs and tables its uniqueness began to show. Coupled with detailed statistical features normally found in packages such as SPSS and Minitab, the software made a strong case for itself.

Snap Survey also allows the user to publish the audit to users via email and on websites. The time to conduct the audit using this process is also drastically reduced in particular within medium to larger organizations. Rather than filling in the audit with pen and paper and entering the data later on onto a spreadsheet, the audit can be completed in a variety of ways. For example it can be conducted using a personal digital assistant (PDA) and the audit if required can be submitted for analysis instantaneously. Alternatively it can be completed on paper, scanned and read automatically for analysis.

4.4 5S Sustainability Audit Development

The development of the audit took into account the requirements of the client and also utilised personal experience of performing 5S audits in a variety of industry sectors. The audit itself consists of two different sets of questions these are lead questions and specific audit questions based on the use of 5S within a specific area within an organisation.

4.4.1 Lead Questions

The first set of questions is general leading questions and the information from these questions will aid in the analysis phase. These general questions clarify certain information about the individual conducting the audit itself. These questions are used as variables which can be cross referenced with the 5S audit questions using the software application and this will aid in the generation of conclusions and recommendations with regard to sustainability of the 5S process. These questions include the auditors, gender, and role, duration of 5S training, department and company level amongst others. This will be covered in detail later in the paper. The lead questions ask for the following typical information shown in figure 4.2.

1. **Gender**
 Male
 Female

2. **What is your age?**
 Under 18
 18 to 25
 26 to 35
 36 to 45
 46 to 55
 56 to 65

3. **Length of Company Service**
 up to 1 Year
 1-3 years
 3-5 years
 6-10 years
 11 years +
 N/A e.g. not company employee

4. **Department / Function Assessed**
 Production
 Logistics
 Administration
 Finance
 Laboratory / Testing / Inspection
 R&D
 Customer Service
 Other

5. **Organisation Level**
 Operations (e.g. shop floor)
 Supervisory
 Middle Management
 Senior Management
 Other e.g. external to organisation or trainer

6. **Have you had formal training in 5S?**
 Yes
 No

Figure 4.2: Example Lead Questions

4.4.2 Audit/Observational Questions

The 2nd set of questions is structured around each of the 5S Phases. Each individual phase has its own set of five questions or observations. Each question can be rated over a defined range from a minimum of zero to a maximum of four. Zero being observed as “never” and a four is deemed as being “always”. Figure 4.3 is an example of the questions for the straighten phase.

0 = Never, 1 = Rarely, 2 = Half the time, 3 = Mostly, 4 = Always

Straighten Audit	0	1	2	3	4
Is there a location for every item stored?	<input type="radio"/>	<input type="radio"/>	<input type="radio"/>	<input type="radio"/>	<input type="radio"/>
Is every item in its correct location e.g. in relation to labels?	<input type="radio"/>	<input type="radio"/>	<input type="radio"/>	<input type="radio"/>	<input type="radio"/>
Is the storage area generally clean & tidy?	<input type="radio"/>	<input type="radio"/>	<input type="radio"/>	<input type="radio"/>	<input type="radio"/>
There is an updated and clear storage plan (visible) available	<input type="radio"/>	<input type="radio"/>	<input type="radio"/>	<input type="radio"/>	<input type="radio"/>
Are all cables/leads/pipes tied up & safe?	<input type="radio"/>	<input type="radio"/>	<input type="radio"/>	<input type="radio"/>	<input type="radio"/>

Figure 4.3: Example Generic 5S Straighten Phase Questions

With a total of 25 questions for the five phases of the 5S approach and a maximum rating of four for each observation, a maximum score of 100 can be attained from the 5S sustainability audit assessment. The development of the individual 5S questions themselves was conducted from personal industrial experience of 5S implementation and benchmarking of other 5S approaches from other organisations.

A useful feature of the Snap survey software is its ability to create multi language questionnaires which allow the user to switch from one language to another. Therefore when for example an English only speaker has to email an audit to a Dutch client, the audit is published in Dutch. When the questionnaire is returned in Dutch the English speaker can switch over using a “tab” function within the software and conduct the analysis in English with no problems understanding the Dutch auditor’s answers.

4.5 Proof of Concept Testing

The 5S audit required some initial testing to identify any issues that may exist with the proof of concept (POC). Once the questionnaire is developed within the software application it needs to be published. There are a variety of ways the questionnaire can be issued but the most suitable in this situation due to the clients being in the Netherland and Sri Lanka was to publish the questionnaire as an HTML file to be emailed.

Once published the user simply emails the audit to all the auditors of the 5S process. This can include cell operators, managers, 5S trainers and external 3rd party assessors. The file once received is downloaded by the auditor and they complete the audit when the time is appropriate for them. When the audit is complete they simply click on the submit button and the audit is returned to the creator of the 5S sustainability audit. All the returned audits should be left as unopened mail and to access the data the Snap Survey software imports the data directly from the mailbox. These files are now classed as opened files in the mailbox. A process flow diagram depicting this process is shown in figure 4.4.

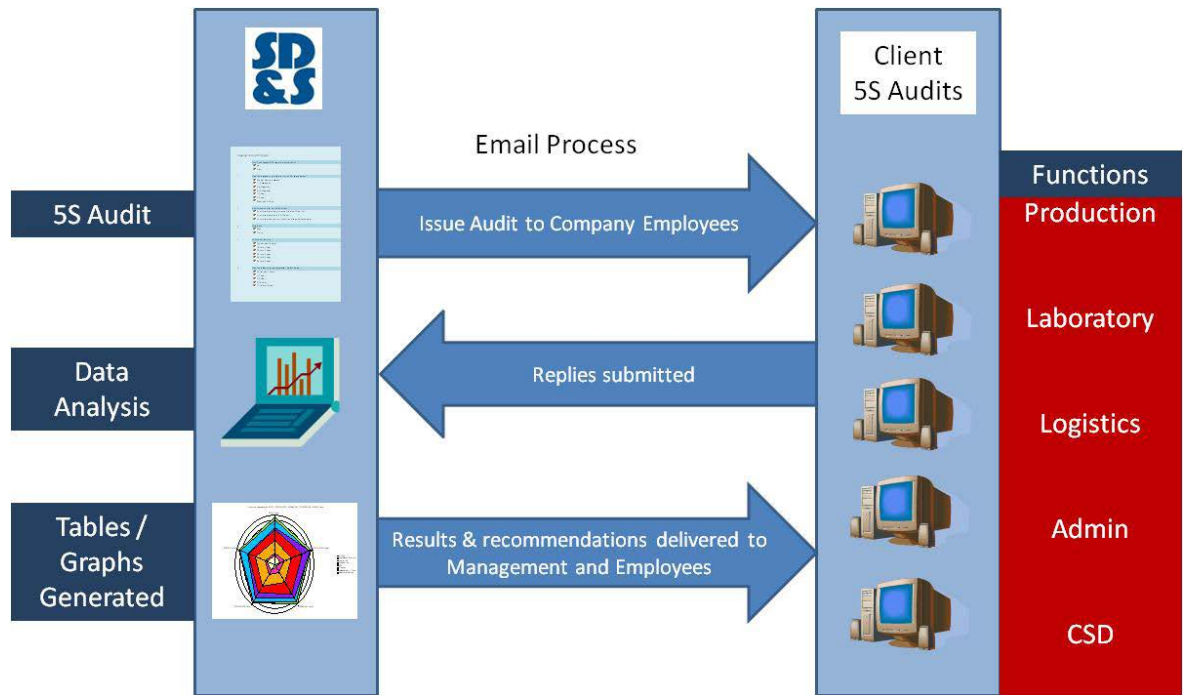

Figure 4.4: Example Process Flow of the 5S Audit

Testing of the send and receive process of the 5S Audit proved relatively trouble free with no issues or problems. Completed example audits were collected for both the Dutch and Sri Lanka 5S audits and the next phase would be to develop the analysis process of the results.

4.6 Analysis of Data

In order to create the graphs and charts the software application had to have some logic applied. This consisted of creating a specific weighting factor for each value for each of the 5S audits questions. This was required in order for the software to understand that an observation rated as a 3 for example should be scored as a 3 within the application. Also for each of the 5S phases these had to be labelled via a “dummy” question or label in order for the graphs and tables to understand which questions were related to which phase of the 5S approach. These then needed to be applied to specific routing logic within the software.

With the necessary logic created, it was possible to create the tables and charts as required by the client. By combining the variables from the leading questions with the observations from the 5S audit it is possible to obtain some very interesting analysis and comparisons.

Taking the case data compiled from Sri Lanka textiles sector it is possible to analyse the different between the leading questions and the 5S audit questions. Initial analysis of this data in figure 4.5 and figure 4.6 shows a table and radar chart for comparing the leading question of department with the 5S audit responses. This shows clearly how each department is performing with regard to its 5S program for each individual phase. It can clearly be seen that administrations 5S programme is performing very well apart from the Sustain phase. Whilst in finance there seems to be issues across most of the 5S Phases, therefore highlighting a general issue with the 5S deployment within the area.

	Base					
		SORT Total	STRAIGHTEN Total	SWEEPING Total	STANDARDISE Total	SUSTAIN Total
Base	-	-	-	-	-	-
Missing						
<i>No reply</i>	-	7.33	9.67	12.00	8.33	1.00
Department / Function						
<i>Production</i>	-	11.38	12.63	13.13	9.63	7.00
<i>Logistics</i>	-	16.00	7.50	16.50	14.50	15.00
<i>Administration</i>	-	16.50	18.00	17.75	16.50	8.00
<i>Finance</i>	-	7.00	9.00	9.00	9.00	12.00
<i>Laboratory / Testing / Inspection</i>	-	17.00	16.00	14.00	15.00	5.00
<i>R&D</i>	-	8.50	9.25	14.75	9.25	7.75
<i>Customer Service</i>	-	15.50	15.00	18.50	17.00	7.50
<i>Other</i>	-	12.57	14.71	15.43	14.00	13.86

Figure 4.5: Table of 5S performance in relation to Function/Department

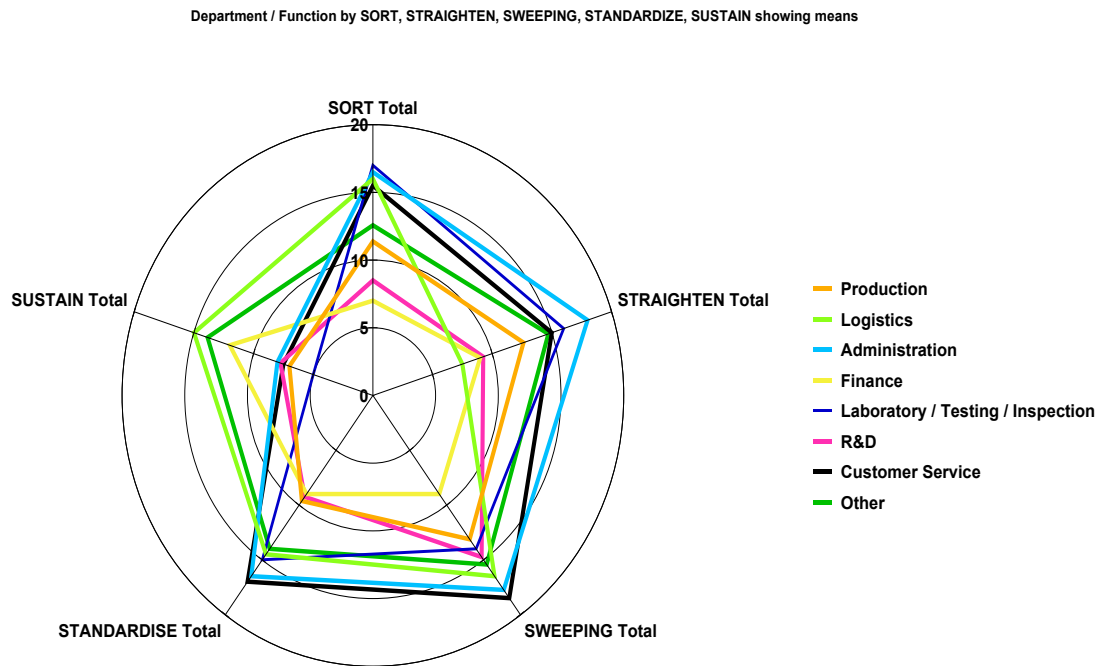

Figure 4.6: Radar Chart of 5S performance in relation to Function/Department

The reasons for the success and failure may not be apparent initially however by continuing the analysis using the other leading questions a picture can start to be developed of what is happening in each area. By adding variables such as “how long have you been trained” you could determine that the department has only recently being trained for example. Or it could be that certain employees have just joined the organisation and have little or no 5S awareness.

There could also be differences in opinions between different levels of the organisation demonstrating lack of management commitment or shop-floor fear of the 5S approach. This is where using the right leading questions with the general audit questions is crucial. Initial analysis of statistical outputs from the 5S Audit showed how the tool can clarify valuable information to the user. The sample detailed in figure 4.7 contains statistics from Sustain Questions 15a to 15e.

	Base	Missing		Descriptive Statistics						
		No reply	Count	Mean	Mode	Median	Minimum	Maximum	Standard Deviation	Variance
Have standard markings, labels, etc been used	32	0	32	3.3125	4	3.5	1	5	1.1022	1.214844
Is the team/cell activity board topical & up to date?	32	0	32	3	2	3	1	5	1.118034	1.25
Are all regular/moveable items 'footprinted'?	32	0	32	3.03125	4	3	1	5	1.334269	1.780273
Are all documents/working instructions clearly identified?	32	0	32	3.4375	4	4	1	5	1.170937	1.371094
Is emergency equipment clearly marked & visible?	32	1	31	4.516129	5	5	1	5	0.79802	0.636837

Figure 4.7: Table of Statistics from Sustain Questions 15a to 15e

These clarify where more effort is required within that phase of the 5S approach within the topicality of team boards (mean 3) however the emergency equipment on the whole is highly visible (mean 4.516) and focus of effort is needed less here. The statistics also depict the variance of the results and where this is high, further investigation should be placed to determine why this is so within particular departments.

4.7 Conclusions and Recommendations

Initial feedback from industry clients and fellow academics of the proposed 5S sustainability process has been positive thus far. Referring to the customer requirements for the process and the market needs defined earlier in the paper all of these have been met by the study. It has been important to meet these criteria for the model to be successful as part of the development process.

Managerial implications for this type of process are widespread as it can help make both strategic and operational decisions within the deployment of the 5S approach. It provides focus on where effort should be placed to get value added benefits and where effort should not be placed reducing waste.

The Snap Survey software has proved useful in its abilities to combine the questionnaire element with statistical capabilities to be able to produce tables and graphs which can be used to clarify opportunities for improvement in specific areas of the 5S steps. The ability to combine the output from the leading questions with the 5S audit question enables the user to “drill down” to get to the root cause or close to it. This will help reduce the time to get to the root cause and subsequently reduce the time to solve the problem.

The 5S Audit tool does have some small limitations over conventional audits methods in existence, namely the initial cost of the software and the time required in getting acquainted with the various functions and complexities of the Snap survey. However when these are compared to the time it takes to collect and analyse data for conventional audit processes the payback is soon realised. When this is also coupled with the abilities of the software analysis capabilities the disadvantages become less important.

Lessons learnt from this research have been the overall size of the project was bigger than initially envisioned. Therefore following these initial trials of the 5S Sustainability model, it is the intension to conduct full statistical analysis of case study data and further trials to fully understand its benefits and potential areas for improvement.

Once this process is completed the next phase will be to develop the sustainability model for other Lean Six Sigma tools such as FMEA, DOE, 7 Wastes, and Value Stream Mapping. The ultimate aim will be to develop a full Lean Six Sigma Sustainability Assessment (LSSSA) process and an Environmental (ELSSSA) version also. It is proposed that the assessment tool could be used both by external consultants and/or by trained internal employees to gauge how departments are performing in relation to Lean Six Sigma tools and techniques.

4.8 References

Carnell, M 2008, Understanding Six Sigma deployment failure, www.isixsigma.com

Flinchbaugh, J 2006, ‘How to Avoid the 5 Biggest Lean Pitfalls’, *Assembly Technology Expo*, Rosemont, IL, Sept. 26 2006

Mehta, M 2004, ‘Committing to a Lean Six-Sigma Roadmap’, *IIE Lean Solutions Conference*, Dec. 2005, Orlando, FL

Peterka, P 2005, ‘Exploding Six Sigma Myths’, White Paper, www.sixsigma.us

5 The Impact of 5-S on Organizational Culture: A case study

Helen Reynolds

United Kingdom

Abstract

The purpose of this paper is to explore the relationship that 5-S implementation has on organizational culture. Direct observation through a case study approach was used along with surveys and questionnaires. Out of 31 operators who participated in 5-S training, 20 responded to a follow up questionnaire about the program (a 65 percent response rate). One-hundred percent of these respondents viewed 5-S positively, and thought the program improved their area. These findings imply that the 5-S program was able to positively change the corporate culture in favour of lean methodology. As the focus of this research was a case study organization, further research into this topic in other organizations would allow for a validation of the findings presented in this paper. This research fills a gap in industrial and academic knowledge on 5-S as a means of transforming organizational culture.

Keywords: 5-S, Lean manufacturing, organizational culture

5.1 Introduction

5-S is a Japanese methodology that has gained popularity with Western managers over the past few decades. 5-S is considered a “lean manufacturing” tool by some, and can be part of an organization’s lean journey. This lighting manufacturing firm, located in Scotland, recently began a Lean manufacturing drive and is looking to implement a 5-S program as part of this. They were also interested in changing their organizational culture to one that is a “Lean culture”. This paper discusses relationship between 5-S methodology and organizational culture change found through a case study with the company.

The company (herein referred to as ABC) is part of MNC based in Netherlands. ABC began manufacturing in 1945 and currently houses two separate businesses, Lamps and Luminaires. Between the two businesses there are approximately 350 employees. The case study carried out with ABC was limited to the Luminaires business unit. The complexity of the luminaire products themselves allowed for the site to stay competitive, despite the fact that they assembled in a country with a high price of labour. However, they had a need to implement a lean business strategy in order to avoid being outsourced. The goals for the end of 2009 were to condense operations from two buildings into one using lean principles, and instil a continuous improvement ethos while doing so. 5-S was identified as a fundamental building block to the lean transformation, and was implemented over a period of 3 months. The effects of 5-S implementation on organizational culture were studied.

5.2 Literature Review

Osada was the first to formalize the practice of 5-S in the 1980’s using the Japanese words *seiri*, *seiton*, *seiso*, *seiketsu*, and *shitsuke* to represent different phases in the process of workplace organization (Ho et al. 1995, Sui-Pheng & Khoo 2001; Warwood & Knowles, 2004, Kumar et al. 2007). The Japanese have been using the principles of 5-S for some time, and feel the concept extends beyond the workplace into daily life (Ho et al. 1995, Sui-Pheng & Khoo 2001). The Japanese words have been translated into many English equivalent words (Ho et al. 1995, O’hEocha 2000, Becker 2001, Sui-Pheng & Khoo 2001, Warwood & Knowles 2005, Kumar et al. 2007, Withanachchi et al. 2007), and are shown in table 5.1.

Japanese Word	English Equivalent Word
<i>Seiri</i>	Organize (organization), sort, structure, tidy (tidiness), sift, clean-up, clear-out
<i>Seiton</i>	Neat (neatness), set (set-in-order), systematize, order (orderliness), straighten, simplify, configure
<i>Seiso</i>	Clean (cleaning, cleanliness), shine, sanitize, sweep, scrub, check, purity
<i>Seiketsu</i>	Standardize (standardization), neatness, standard-clean-up, sustain, systemize, conform, custom
<i>Shitsuke</i>	Discipline (self-discipline), sustain, custom, practice

Table 5.1: 5-S’ and their English equivalents

As is shown in the table, there are equivalent sets of “S” words (such as sort, set, shine, standardize and sustain) or “C” words (such as clear, configure, clean, conform, and custom). The 5-S’s may also be referred to as 5 Pillars owing to Hirano’s (1995) book *The 5 Pillars of a Visual Workplace* (Hubbard 1999). This paper will herein use the aforementioned English set of “S” words when referring to the 5-S’s.

Hirano (1996) describes the 5-S's as follows:

- *Sort*. Sorting is about separating necessary from unnecessary objects, and removing those that are not needed. This may entail throwing items away, loaning or giving them to another department, selling them off, or reducing the quantity to the lowest possible amount. The last option follows the “one-is-best” principle of organization.
- *Set*. Setting requires the implementation team to analyze the best layout for efficiency. This means reducing retrieval time and the time it takes to put an item back. The system must also be one that everyone can see and understand.
- *Shine*. Shining is a process of cleaning and refreshing. This makes the area aesthetically pleasing and more peaceful. It is important to pay attention while cleaning in order to gather data about various problems in the production process. This data can be analyzed in an attempt to remove the root problem of dirt or clutter coming into the area.
- *Standardize*. Standardization is continuously maintaining the organization put in place. This includes personal and organizational cleanliness, emphasizing the visual management aspect of 5-S. Visual management is the practice of using visual aids (shadow boards, color coding, labeling, etc.) to make communications simple and effective. White or light colored clothes or paint may indicate how clean a work area is.
- *Sustain*. Sustaining 5-S is very self-descriptive. It is finding a way to get everyone to conform to the system put in place, and keeping standards at a minimum level over time. This process involves employees breaking old and bad habits and re-learning how to interact with the system. Self-discipline is extremely important, as it will mean everyone acts responsibly rather than merely avoiding reprimand.

5.2.1 Potential benefits

The literature points out many potential benefits that 5-S may have for a company. An extensive list of the potential benefits of 5-S are listed in table 5.2. Several case studies in a wide range of industries back these assumptions. Bryar & Walsh (2002) reported an Australian management consultancy and training business not only saw some of the benefits listed but also had a feeling of being re-energized by the results of 5-S. Hubbard (1999) reported that the use of 5-S in his manufacturing company lead to a recovery of 10 percent floor space, better use of space available, and aid in cleanup after a flood (due to taped out areas identifying where items needed to be replaced). Withanachchi et al. used 5-S to identify management areas that needed improvement in a public hospital in Sri Lanka. As far as financial benefits provided by 5-S, there is little information currently available. However, Kumar et al. (2007) have recently proposed a way of recording such benefits using the quality circle financial accounting system.

Benefit	Reference
Increased organizational performance and productivity/ better organization communication	Ho & Cicimil 1996, Warwood & Knowles 2004, Chapman 2005, Van Patten 2006, Kumar <i>et al.</i> 2007, Gapp <i>et al.</i> 2008
Improved overall staff involvement	Ho & Cicimil 1996, Schorn 1998, O'hEocha 2000, Sui-Pheng & Khoo 2001, Warwood & Knowles 2004, Chapman 2005, Kumar <i>et al.</i> 2007
Better understanding of customers needs and better relationships and communication with them	O'hEocha 2000, Ho <i>et al.</i> 1995, Kumar 2007, Withanachchi <i>et al.</i> 2007, Gapp <i>et al.</i> 2008
Better long term strategic vision	Withanachchi <i>et al.</i> 2007, Gapp <i>et al.</i> 2008
Improved levels of health and safety, and environmental protection	Pojasek 1999, O'hEocha 2000, Warwood & Knowles 2004, Van Patten 2006, Kumar <i>et al.</i> 2007, Withanachchi <i>et al.</i> 2007
Improved job satisfaction/ morale/ motivation	Pojasek 1999, Bryar & Walsh 2002, Withanachchi <i>et al.</i> 2007, Gapp <i>et al.</i> 2008
Decreased floor space needed/ better use of floor space available	Hubbard 1999, Chapman 2005
Reduced search time for materials/ tools/ etc.	Ho <i>et al.</i> 1995, Hubbard 1999, O'hEocha 2000, Warwood & Knowles 2004, Kumar <i>et al.</i> 2007
Early detection/prevention of defects or failures	Pojasek 1999, Chapman 2005, Gapp <i>et al.</i> 2008
Improve team spirit/ cooperation	Ho 1999, Bryar & Walsh 2002, Warwood & Knowles 2004, Kumar <i>et al.</i> 2007
Improved positive values/ self-image	Van Patten 2006
Decreased waste (material or movement)	Ho & Cicimil 1996, Schorn 1998, O'hEocha 2000, Warwood & Knowles 2004, Van Patten 2006, Kumar <i>et al.</i> 2007
Better/more organized working environment	Schorn 1998, O'hEocha 2000, Bullington 2003, Warwood & Knowles 2004, Kumar <i>et al.</i> 2007, Humphrey 2008
Support for a visual workplace	Ho 1998, Bullington 2003, Chapman 2005, Kumar <i>et al.</i> 2007
Increased quality	Ho & Cicimil 1996, Schorn 1998, Pojasek 1999, Kumar <i>et al.</i> 2007, Withanachchi <i>et al.</i> 2007

Table 5.2: Potential Benefits of 5-S

5.2.2. 5-S for Lean culture change

5-S methodology has been noted as a good foundation for lean manufacturing. Lanigan (2004) believes, "Developing a strong foundation to be truly lean and create a competitive differentiator is critical". He thinks 5-S methodology is the tool required for this task. The rigid framework of 5-S and the daily reinforcement of 5-S activities are reasons why the system can instil the discipline and visual management skills needed to become lean. Pojasek (1999) shares this view stating that 5-S is the starting point for any continuous improvement activity on the shop floor. He believes 5-S provides the right mix of employee involvement and empowerment to motivate them to want to embrace lean manufacturing. Hemmant (2007) echoes these sentiments by saying, "5-S should be viewed as critical to the success of Lean thinking and concepts". All the authors agree that the endless drive to remove waste from the work area sets shop floor employees up with the right skills and attitudes for the lean cultural transformation. Additionally, they believe that without a working 5-S system, all other lean tools will be rendered ineffective (Pojasek 1999, Lanigan 2004, Hemmant 2007). It is possible that 5-S can provide a springboard into lean manufacturing, aiding the transition into lean organizational culture.

5.3 Methodology

The case study consisted of two primary data sources: surveys and questionnaires, and direct observation. The surveys gauged the baseline organizational culture and practices at ABC; the questionnaires and direct observation was aimed at measuring the effectiveness of, and enthusiasm towards the 5-S program implemented. The secondary data source, or literature review, helped first to create a 5-S training program and then to compare the program with others experience.

The organizational culture survey was given to people at all levels of the organization and consists of eleven sections. The first section, personal info, gathered personal demographic data about each participant. The next nine sections discussed the following topics: leadership, working together, employee input, customers, communication, suppliers, innovation, processes, and organizational relationships. The last three sections were fill-in-the-blank response sections where participants could comment on the people, stories and symbols that represent their company and culture.

5-S surveys were also given to employees of all levels, but a different survey was specifically tailored to each corresponding level. The purpose of this was to have every respondent answer the questions as they felt an operator would. The first three sections of the survey were statements written to focus on the potential benefits of 5-S methodology according to the literature. The sections in the survey were: work area, teamwork, and change. There were also two questionnaires distributed to participants of the 5-S training program. The first of these questionnaires was given on day one of training, and will be referred to as the “before” questionnaire. The other was given on the last day of training and will be referred to as the “after” questionnaire. The questionnaires were written to judge the operator’s knowledge about 5-S and their enthusiasm.

The final primary data source was direct observation of the researcher. The researcher was involved in implementing the 5-S pilot program within ABC. The pilot program was a week long and consisted of two parts: a theory section and a practical section. Each day of the week represented a different 'S', with the first day doubling as an overview of 5-S and "Sort" day. Participants met in a conference room and were shown a slide set containing the theory behind the day's 'S'. They were then given instructions for an activity that corresponded with that 'S' and went to the shop floor to perform this activity. As a result of implementing this pilot program, the researcher gained a deep understanding of the attitudes and behaviour of shop floor employees towards the program. These observations are critical in piecing together the information gathered in the questionnaires and semi-structured interviews.

5.4 Results

The response rate can be calculated using the formula: total number of responses/(total number in sample - ineligible) (Saunders et al. 2007). The population surveyed included all of top and middle management and those team leaders and operators involved in the 5-S training¹. This made the total number in the sample 72 (11 management team members + 26 middle managers + 35 team leaders/ operators). Thirty-four organizational culture surveys were returned, making the response rate 47%. Fifty-eight returned the 5-S survey, making the response rate 80.5%. The discrepancy the response rate can be attributed to the fact that operators participating in the 5-S program were required to fill out the 5-S survey as part of the training (The organizational culture survey was handed out to be filled in and returned). The 5-S questionnaire was designed for operators participating in 5-S implementation, making the total population 31. There were 26 surveys returned for the "before" questionnaire- but four of these contained one or more questions with a blank answer. These surveys were considered invalid and were removed for analysis, making the response rate 71% ((26-4)/31). The "after" questionnaire had a response rate of 65% (20/31).

5.4.1 Organizational culture survey

Figure 5.1 shows the proportions of the different organizational levels. This was the main factor for analysis when looking at responses. The organizational information section consisted of eleven segments, each relating to a different dimension of organizational culture. In nine of the segments participants were given a list of statements to strongly disagree, slightly disagree, slightly agree, or strongly agree with. Most of these statements were "positive" statements, meaning it would be considered a good thing for the participant to agree. An example of a positive statement is, "I can rely on my manager". A minority of statements were "negative" statements, meaning it would be good for the participant to disagree. An example of a negative statement is, "Decisions are only made by the management". For all positive statements, responses were coded in the following way: 1= strongly disagree, 2= slightly disagree, 3= slightly agree, 4= strongly agree. This scale was reversed for negative statements, with 1= strongly agree, and so on. The reason for ranking responses in such a manner was that a score of 1 can always be considered a bad thing, and a score of 4 can always be considered a good thing. Finally, the last three sections consisted of one short answer question each.

1 The responses for team leaders and operators were combined into one group because the number of team leaders was too low to be used for analysis.

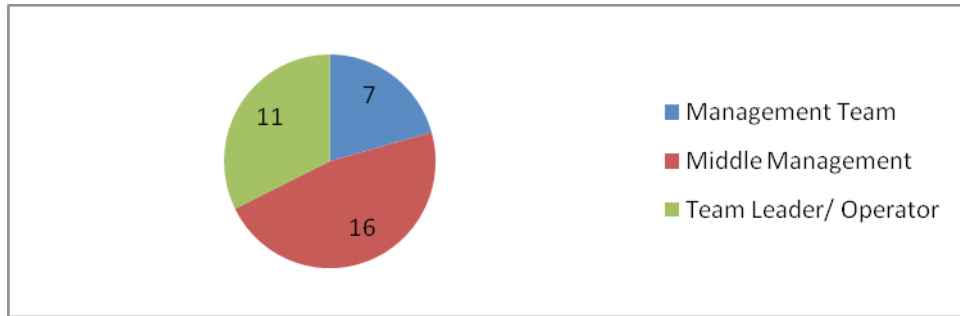

Figure 5.1: Proportion of responses to the organizational culture survey by organizational level

The demographical dimensions shown in figure 5.1 were used as a basis to compare and analyze the eleven dimensions of culture. Figure 5.2 shows a comparison by organizational level of the average responses across the first nine cultural dimensions. It can be said that organizational level and negativity are directly related. In seven out of nine sections the scores consistently dropped as organizational level went down. This indicates that team leaders and operators had a more negative view of the organization than management.

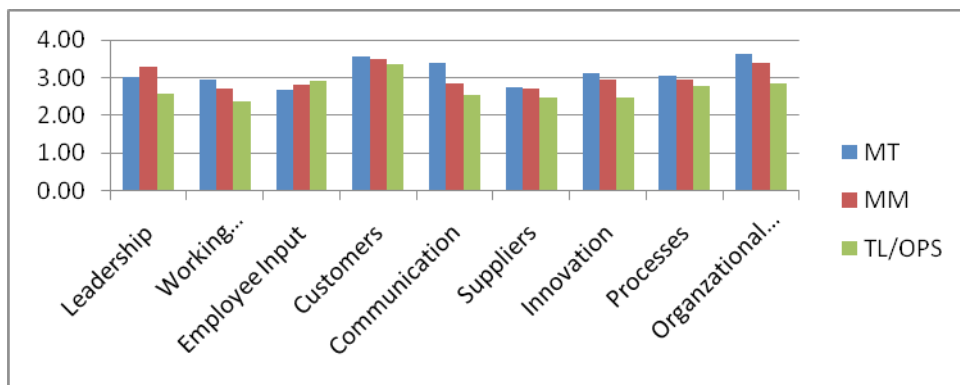

Figure 5.2: Average organizational culture survey results by organizational level

5.4.2 5-S Survey

This survey contained three sections, each with ten statements, one short answer question, and one short answer question and room for comments per section. The short answer and comment sections were often left blank, and the limited responses had many discontinuities; therefore, these questions were considered invalid and are omitted from analysis. The same method of coding responses for positive and negative statements is use as the previous survey.

Figure 5.3 shows the proportion of responses by organizational level. There is a significant increase in the amount of team leaders/ operators participating in this survey in comparison to the organizational culture survey.

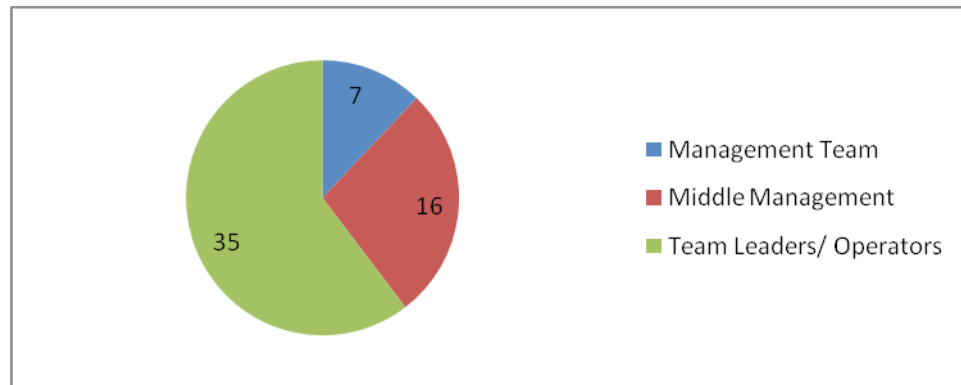

Figure 5.3: Frequency of 5-S survey responses by organizational level

Figure 5.4 shows the composite results of the average of scores from each dimension of 5-S. These statements show a positive trend as organizational level goes down. This indicates that shop floor employees feel more ownership of the production area than management. Because all the statements were tailored to ask the participant to think as the operator would, this is indicative that management does not understand how operators think. The shop floor employees tended to view themselves and their workplace much more positively than management thought they did. Team leaders/operators scores were consistently the most positive.

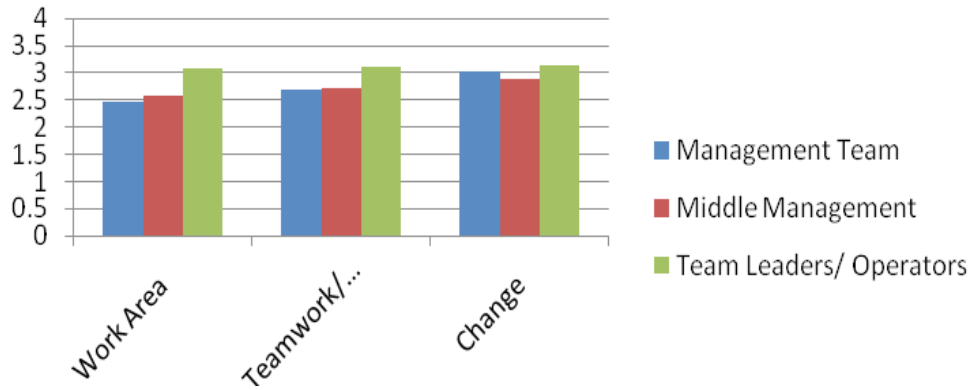

Figure 5.4: Average 5-S survey responses by organizational level

5.4.2.1 5-S Before questionnaire results

This section was a fill-in-the blank questionnaire about 5-S given to operators participating in 5-S training. The questions were asked to gauge the level of knowledge that operators felt they currently had about 5-S methodology, and whether they are enthusiastic about implementing 5-S in their area. The percentages of responses are shown in table 5.3.

Question	% responding “yes”	% responding “no”
Do you feel you have a clear idea about what 5-S means?	41%	59%
Have you participated in 5-S training before?	18%	82%
Are you enthusiastic about implementing 5-S in your work area?	77%	23%
Do you think implementing 5-S in your work area will be successful?	77%	23%

Table 5.3: Questions and responses to the before questionnaire

The responses can be broken into four categories. The first category is operators who did not know what 5-S was, and were not enthusiastic about implementing it. The second is operators who knew what 5-S was, but were not enthusiastic about implementing. The third is operators who did not know what 5-S was, but were enthusiastic. The fourth is operators who knew what 5-S was and were enthusiastic. The frequencies of operator knowledge and level of enthusiasm is shown in figure 5.5.

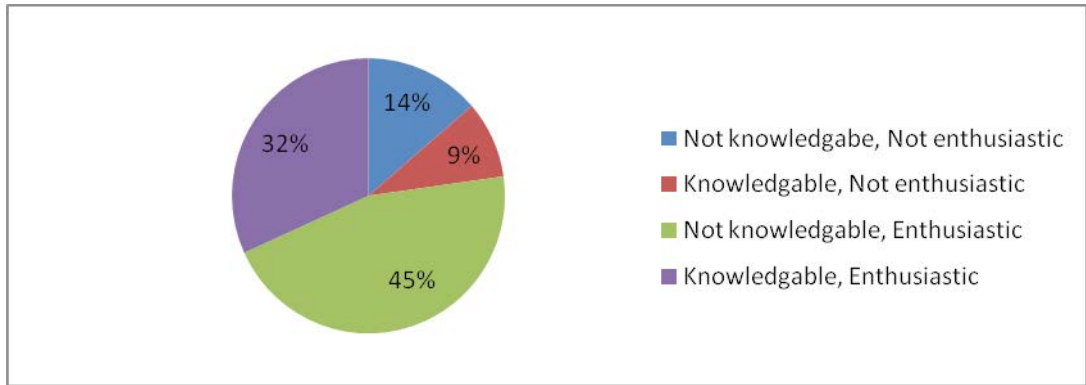

Figure 5.5: Frequencies of before questionnaire responses by knowledge and enthusiasm

The figure shows that more than half the participants, whether knowledgeable about 5-S or not, were enthusiastic to try the program; this makes the buy-in rate before the training program 77%. However, this also means nearly a quarter of participants were not enthusiastic about implementing 5-S. Particularly worrying was the small percentage (9%) of operators who felt they knew what 5-S was but did not want to implement it in their work area. Some of the negative comments received were, “Production is more important”, or “We have seen this tried before and fail”, or “It won’t last”.

5.4.2.2 After questionnaire results

The after questionnaire showed amazingly positive responses, shown in table 5.4.

Question	% responding “yes”
Can you now name the 5-S’s?	100%
Do you feel this training has given you a clear idea of what 5-S means?	100%
Did you find this training beneficial?	100%
Are you enthusiastic about continuing to use 5-S in your work area?	100%
Do you think implementing 5-S in your work area was/will continue to be successful?	100%

Table 5.4: Questions and responses to the after questionnaire

Some of the positive comments shared were:

- Area is much more organized and tidy- and therefore more pleasant to work in.
- The lines are looking a lot better. It is better if you work in a clean and tidy area.
- I have enjoyed learning about the 5-S’s
- It is much easier to find things when it is tidier. It makes the production lines more efficient and better when people are training on new lines.

- You can see what you need for the job right in front of you- all in order- no more searching. There is more respect for a work area that is clean and tidy. I thought my work area was clean and tidy but now that the 5-S has been done I realized it wasn't as good as I first thought. I am glad the 5-S program was done.
- It will make the job more pleasant to do.
- It's good to come to work and find your area tidy and to be able to find all the material easily.

The results of the training can then be said to be:

- A 59% increase in 5-S knowledge
- An 82% increase in operators formally trained on 5-S methodology
- And, a 23% increase in buy-in

This is huge improvement in positive thinking from before the 5-S training was implemented.

5.4.3 Organizational Culture

Through the analysis of the surveys it was possible to measure organizational culture at ABC. It is important to remember that any organizational culture is complex and tangled with the individual personalities that comprise the organization. This creates a need for organizational culture to be discussed on a macro level. The organizational culture is hierarchical, mildly negative, and resistant to change. Yet, it is also loyal, innovative in terms of product design, and customer driven.

It is clear that ABC has not achieved a lean culture yet. ABC is in the primary phase of their lean journey- implementing lean tools and techniques. These are being implemented in what can be described as a piecemeal fashion. At the time of writing these tools and techniques are: value stream mapping, product grouping, Kaizen events (focused on converting the production process to cellular manufacturing), production supermarkets, and the 5-S pilot program.

5.4.4 The role 5-S played in culture change at ABC

ABC faces the need to progress into phase two of lean maturation, culture change, or they have little chance of their lean programme sustaining. The organization also needs to be able to use lean tools and techniques as a vehicle to do so. It can be said that the 5-S pilot program positively impacted culture at ABC. The “before” and “after” questionnaires are proof that the program raised buy-in by 23%. The positive comments showed that employees enjoyed the experience, and felt rewarded by the benefits seen through 5-S implementation. The structure of maintaining 5-S will also be a good exercise for management to support the shop floor in lean activities. The program was centred on employees being empowered to make their own decisions, with management used as a support tool rather than a controlling force. The program changed attitudes of those who were either apathetic or negative towards 5-S implementation. This supports the idea that 5-S is a “paving stone” for lean, if the positivity seen transfers into enthusiasm for other programs being implemented.

Although it remains to be seen how this impact will show in the future, it can be said that employee attitude was absolutely improved. The fact that ABC is just beginning their lean journey means they have a lot of work to do before their employees will embrace the lean philosophy, and will accept the changes needed for a lean culture. However, with positive steps forward such as the 5-S implementation program they are on their way to progressing into phase two of lean maturation. The literature tells us this should not happen for a year or so more, but the fact that 100% of participants responded positively to the 5-S program following its implementation is encouraging that the organization will, in fact, get there eventually.

5.5 Conclusion

The aim of the case study was to explore the relationship between the implementation of 5-S methodology and organizational culture. First, organizational culture at ABC had to be defined. This was accomplished through the use of several instruments, and was found to be a mix of both positive and negative factors. It was also shown that the culture is not yet a lean culture. Second, a change in culture needed to be measured from before and after the 5-S program was implemented. This was done by using the 5-S questionnaire. The responses proved that 5-S shifts organizational culture by improving attitude and buy-in towards lean programs. These results support the theory in that 5-S can be used as a paving stone for other lean methodologies.

This knowledge allows ABC to progress further in their lean journey. They will be able to implement 5-S across the entire site and continuously improve the workplace while doing so. They will also be able to use the positivity fostered through 5-S implementation to push other lean objectives forward. Furthermore, they will need to progress through a full culture change before their lean journey will start to mature. The knowledge gained from the study was that 5-S proved to be a good starting point for a lean journey. The discipline 5-S instils will create a platform for other lean tools and techniques to thrive upon. Eventually, ABC should meet their goals of full organizational culture change if they continue on the path they started through 5-S implementation.

5.6 References

- Becker, JE 2001, 'Implementing 5S to Promote Safety & Housekeeping', *Professional Safety*, Aug 2001, pg. 29.
- Bryar, P., & Walsh, M 2002, 'Facilitating Change- Implementing 5-S: an Australian case study', *Managerial Auditing Journal*, vol. 17, no. 6, pp. 329-332.
- Bullington, KE 2003, '5S for Suppliers', *Quality Progress*, vol. 56, no. 9, pp. 56-59.
- Chapman, CD 2005, 'Clean House with Lean 5S', *Quality Progress*, vol. 38, no. 6, pp. 27-32.
- Elbo, RA 1999, 'In the workplace: Localizing the 5-S concept', *Business World*, Manila. Jul 7, 1999. Pg. 1
- Gapp, R., Fisher, R., & Kobayashi, K 2008, 'Implementing 5S within a Japanese context: an integrated management system', *Management Decision*. vol. 46, no. 4, pp. 565-579.
- Hemmant, R 2007, 'the 5Ss to Keeping Lean on Course', *Circuits Assembly*, Aug 2007, pg. 30.
- Hirano, H 1996, *5S for Operators (5 Pillars of the Visual Workplace)*, Productivity Press, New York
- Ho, SK., Cicmil, S., & Fung, CK 1995, 'The Japanese 5-S practice and TQM training', *Training for Quality*, vol. 3, no. 4, pp. 19-24.
- Ho, SK., & Cicmil, S 1996, 'Japanese 5-S practice', *The TQM Magazine*, vol. 8, no.1, pg. 45.
- Ho, SK 1997, 'Workplace learning: the 5-S way', *Journal of Workplace Learning*, vol. 9, no. 6, pp. 185-191.
- Ho, SK 1998, '5-S practice: a new tool for industrial management', *Industrial Management & Data Systems*, vol. 98, no. 2, pg. 55.
- Ho, SK 1999, '5-S practice: the first step towards total quality management', *Total Quality Management*, vol. 10, no. 3, pp. 345-356.
- Ho, SK 1999, 'Japanese 5-S- where TQM begins', *The TQM Magazine*, vol. 11, no. 5, pg. 311.

- Ho, SK 1999, 'The 5-S auditing', *Managerial Auditing Journal*, vol. 14, no. 6, pp. 294-302.
- Hough, R 2008, '5S Implementation Methodology', *Management Services*, vol.52, no.2, pg. 44.
- Hubbard, R 1999, 'Case study on the 5S program: the five pillars of the visual workplace', *Hospital Material Management Quarterly*, May 1999, vol.20, no.4, pg. 24.
- Kobayashi, K., Fisher, R., Gapp, R 2008, 'Business improvement strategy or useful tool? Analysis of the application of the 5S concept in Japan, the UK, and the US', *Total Quality Management*. vol.19, no. 3, pp. 245-262.
- Kumar, RSP, Sudhahar, C., Dickson, JF, Senthil, V., & Devadasan, SR 2007, 'Performance analysis of 5-S teams using quality circle financial accounting system', *The TQM Magazine*, vol. 19, no. 5, pp. 483-496.
- Lanigan, J 2004, '5S Provides Competitive Lean Foundation', *Surface Mount Technology*, May 2004, pg. 70.
- O'hEocha, M 2000, 'A study of the influence of company culture, communications, and employee attitudes on the use of 5Ss for environmental management at Cooke Brothers Ltd', *The TQM Magazine*, vol. 12, no. 5, pp. 321-330.
- Pojasek, RB 1999, 'Five Ss: A Tool That Prepares an Organization for Change', *Environmental Quality Management*, Autumn 1999, pp. 97-103.
- Royal Philips Electronics 2009, *Lighting Business Highlights*. [Online]. Available at <http://www.philips.com>.
- Saunders, M., Lewis, P., & Thornhill, A 2007, *Research Methods for Business Students*, Pearson Education Limited, Essex:
- Schorn, T 1998, 'The 5-S Program: straightening up shop floor operations', *Modern Casting*, Nov 1998, vol.88, no.11, pg. 41.
- Sui-Pheng, L 2001, 'Towards TQM- integrating Japanese 5-S principles with ISO 9001:2000 requirements', *The TQM Magazine*, vol. 13. no. 5, pp 334-340.
- Sui-Pheng, L., & Khoo, SD 2001, 'Team performance management: enhancement through Japanese 5-S principles', *Team Performance Management: An International Journal*, vol. 7, no. 7/8, pp. 105-111.
- Van Patten, J 2006, 'A Second Look at 5S', *Quality Progress*, vol. 39, no.10, pp. 55-59.
- Warwood, SJ., & Knowles, G 2004, 'An investigation into Japanese 5-S practice in UK industry', *The TQM Magazine*, vol. 16, no. 5, pp. 347-353.
- Withanachchi, N., Handa, Y., Karandagoda, KKW., Pathirage, PP., Tennakoon, NCK., Pullaperuma, DSP 2007, 'TQM emphasizing 5-S principles', *International Journal of Public Sector Management*, vol. 20, no. 3, pp. 168-177.

6 Application of Design for Six Sigma Processes to the Design of an Aero Gas Turbine

Phil Rowe

Bourton Group

Email: Phil.Rowe@bourton.co.uk

Gordon May

Aerospace Equipment Manufacturer

UK

Abstract

Gas turbines are highly complex systems with many competing and increasingly onerous requirements, for example: lower emissions, improved availability and lower running costs. This means that future designs will be driven to be lighter in weight, operate at higher and higher temperatures and speeds to reduce fuel burn, whilst at the same time maintaining acceptable life and overall performance characteristics. However, it is important to recognise that all of these requirements must also be *robust* (insensitive) to the effects of variation (“noise”) to which the gas turbines will be subjected throughout their lives.

In order to better identify solutions to these requirements a number of new technologies are being developed in research programmes and then applied in full engine programmes. As an example of this improvement activity, *Design for Six Sigma* (DFSS) has been applied to the design of a specific component – a High Pressure Turbine (HPT) disc – the result of which will then provide a template for a generic robust design process going forward that can produce better designs faster.

The aim of this paper is to show how DFSS was applied, using a “DCOV” methodology, to result in a quantitatively robust HPT disc design. An overview of the DCOV methodology will be given including usage of some of the key tools, such as: Quality Function Deployment (QFD), Design of Experiments, Surrogate modelling, Analytic Hierarchy Process (AHP), Monte Carlo simulation, Data Mining and parameter design. This will be followed by a review of the DCOV process for the HPT disc example.

Keywords: DFSS, AHP, QFD, Design of Experiment, High Pressure Turbine

6.1 Introduction

Although predictive techniques for engineering design (such as statistical tolerancing) have been in widespread use for many years, the methodology “Design for Six Sigma” (DFSS) was popularised by General Electric in the late 1980s. The intent of DFSS is to gain quantitative confidence *in the design stage* that a design will perform as intended, obviating the need for costly re-design after the product, service or process is realised.

Six Sigma product and process improvement via the DMAIC methodology has become reasonably standard, although there are variants of it that incorporate “pre-define” and “knowledge transfer” phases. DFSS, on the other hand, is less well understood and less widely applied. As a consequence, DFSS is less standardised in its implementation than Six Sigma, resulting in several variants of the most widely recognised methodologies: IDOV (Identify, Design, Optimise, Verify) and DMADV (Define, Measure, Analyse, Design, Verify).

In this aerospace equipment manufacturing firm (aero engine, power generation and marine propulsion sectors), the methodology of choice is *DCOV* (Define, Characterise, Optimise and Verify). The following paragraphs explain the objectives and tools & techniques that are typically used in each of these phases of the process.

6.2 Define

The first objective of Define phase is to elicit, understand and prioritise the customer requirements for the design. Prioritisation is achieved by the use of AHP (Analytic Hierarchy Process) (Saaty, 1999). In AHP all the requirements at any level in the hierarchy are formed in to a triangular matrix as shown in figure 6.1. The row items are compared to the column items and the following question is answered in each case: “is the row item more, equally, or less important than the column item in fulfilling the requirement at the level above?” If the row item is deemed more important the comparison is scored between 2 and 9; if less important it is scored between $\frac{1}{2}$ and $\frac{1}{9}$; if they are of equal importance a score of 1 is given – see figure 6.2. At level 1 (the highest level) in the hierarchy, requirements are compared for their importance relative to the *operational definition* of the system. If we consider the example of a domestic toaster, such an operational definition would be “toast bread products safely”.

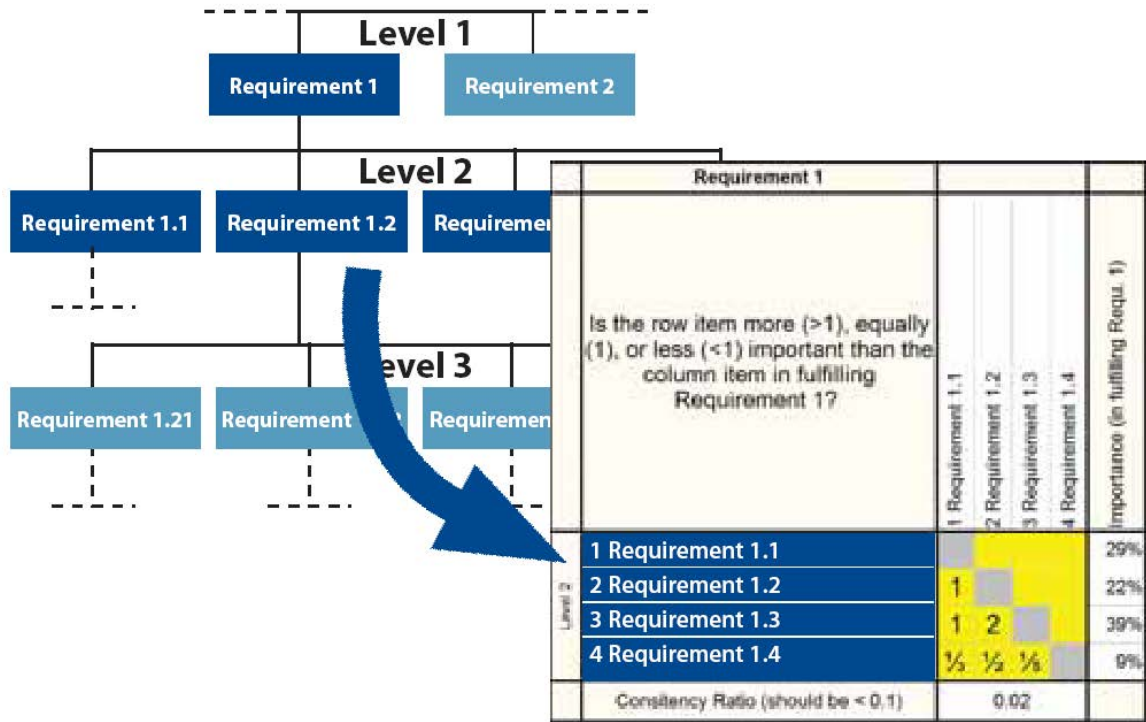

Figure 6.1: Requirements Hierarchy and Prioritisation using AHP

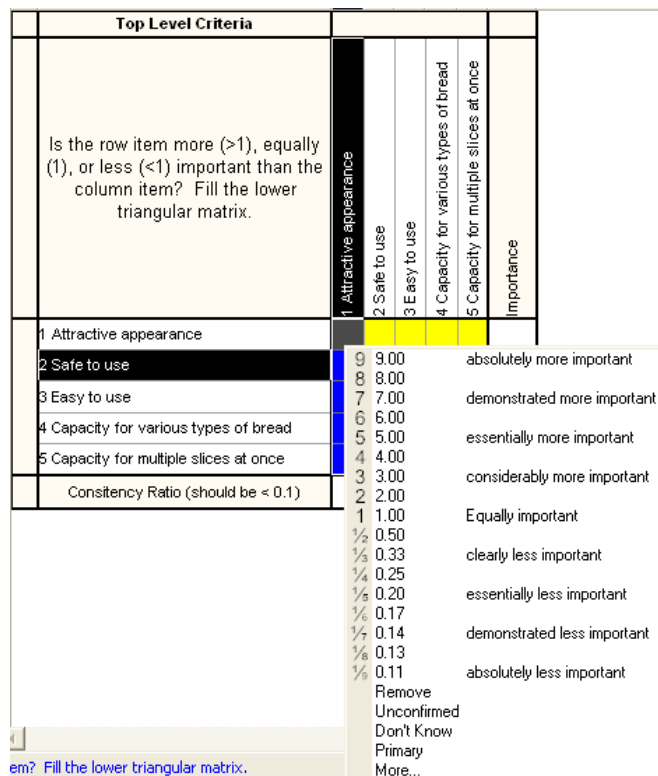

Figure 6.2: Scoring Comparisons in AHP

Notwithstanding the benefits of the discussion that AHP stimulates, another benefit of using AHP is the Consistency Ratio that is calculated as part of the process. This informs us as to whether the set of comparisons (within a group at any level) is self-consistent. A high value (greater than 0.10) indicates inconsistency such that the scores could plausibly have been generated randomly. The result of this process is that we have an importance weighting on a continuous scale of all requirements, rather than a simple ordinal ranking. We can therefore make meaningful *ratio* comparisons between any two requirements – impossible with ranked data.

Requirements are then translated into a technical (functional) specification for the design using Quality Function Deployment (QFD) – see figure 6.3 for a simple example of “QFD1” for a domestic toaster, create in Qualica (see Ref. **Error! Reference source not found.**). Note that the suffix ‘1’ attached to QFD indicates that there are a number of QFD matrices in the requirements translation - flow-down - process, this being the first.

It is important to understand that the functional specification should be *concept invariant* – thus allowing more scope for innovation in proposed design solutions. To illustrate this point, using the domestic toaster example, some of the functions of a toaster are to: load bread products, generate heat, apply heat, monitor toasting, remove from heat, and unload toast. This functionality would be the same whether we were using an electric toaster or a toasting fork! Thinking of the functionality in these generic terms allows us to ask the question “how might we fulfil this function?” *Systems Engineering* tools – such as morphological analysis for concept generation and Pugh matrices (or again AHP) for concept selection – can be used here.

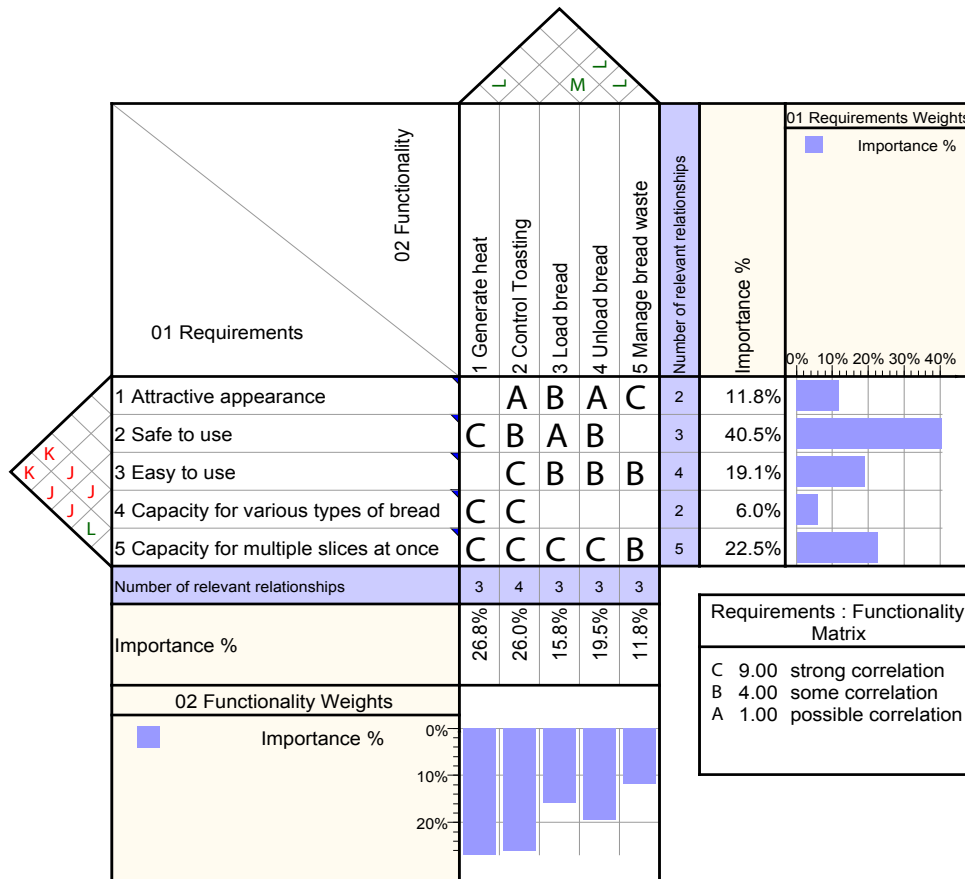

Figure 6.3: Simplified QFD1 for a Domestic Toaster

Once a high level concept has been selected, the next objective in the Define phase is to *establish a detailed nominal design*. In this context, a nominal design is one that, prior to understanding the effects of variation on performance, meets all nominal requirements. In this company design processes are heavily simulation-based; involving computationally intensive and complex calculations of air flow, structural stresses, temperatures etc. For this reason the only efficient and effective means of understanding the design space is to perform these simulations systematically according to a Design of Experiments (DOE) scheme, as opposed to a trial and error (sometimes known as “engineering judgment”) approach. Figure 6.4 explains diagrammatically how the judicious use of DOE allows us to evolve our understanding of the design space whilst minimising computational effort.

Once the nominal design has been established, the final objective in the Define phase is to understand what might influence the **robustness** of the design. In this context, robustness doesn’t mean “bigger, stronger, harder etc.,” rather it refers to a design’s ability to perform consistently in the presence of unavoidable sources of variation (“noise”). In order to achieve this objective it is first necessary to identify, prioritise and quantify the causes of variation in the key design performance metrics - the CTQs (*Critical To Quality* characteristics). We must therefore pose the question “what things will cause the CTQs to deviate from their target values either directly or through affecting the values of the design parameters themselves?”

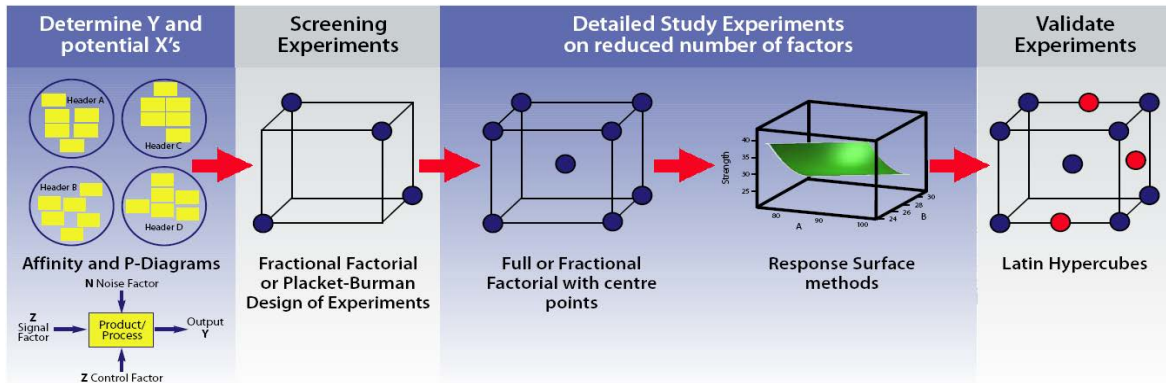

Figure 6.4: Schematic of a “DOE Roadmap”

An example of the latter type of noise (referred to as “type A” noise) is wear – when something wears its physical characteristics change. These changes transmit variability to the outputs that are driven by the design parameter in question. An example of the former type of noise (referred to as “type B” noises) is *road surface condition*; its effect on *stopping distance* (the CTQ for a vehicle’s braking system) is direct: an icy road will influence stopping distance but it will not change the physical characteristics of the braking system itself.

In order to collate both the control factors that influence the performance characteristics of the product *by design* and the noise factors (sources of variation) that may inhibit the ability of those parameters to deliver the desired performance, P-diagrams are employed. Shown in generic form in figure 6.5, a P-diagram elegantly captures and categorises these factors and equates the performance CTQ (labelled “output Y”) of the design as a function of Signal, Control and Noise factors. Incidentally, a signal factor is one whose values are set by the system user in real time with the intent of achieving a desired output; an example for the braking system would be pressure applied to the brake pedal by the driver – by exerting more force on the brake pedal, the driver desires the car to stop more quickly.

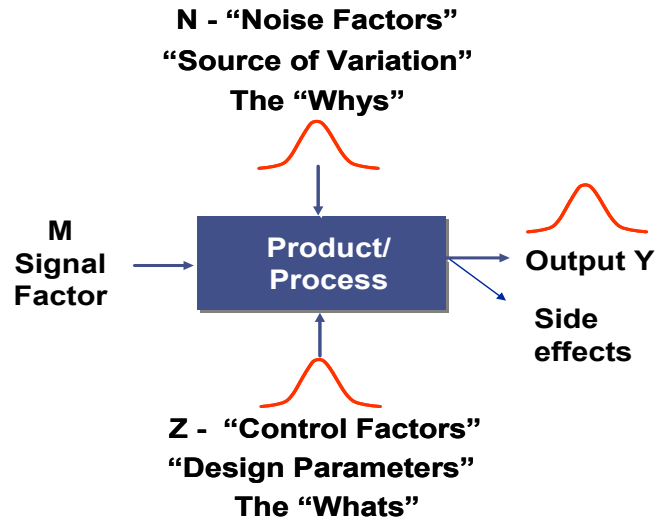

Figure 6.5: A Generic P-diagram

This exercise can reveal many more design parameters and sources of variation than may otherwise have been identified. Although in principle all of these factors will be modelled probabilistically in the Characterise phase of DCOV it is necessary to prioritise which sources of variation will be modelled using real-world data since this is often difficult and expensive to collect.

To achieve this prioritisation a “What-Why table” is employed (see figure 6.6). This involves making both subjective and (preferably) objective assessments of the contribution of noise factors to design parameter variability (type A) and CTQ variability (type B). It results in a set of design parameters that are most influenced by noise, and a set of noises that cause most of the variability.

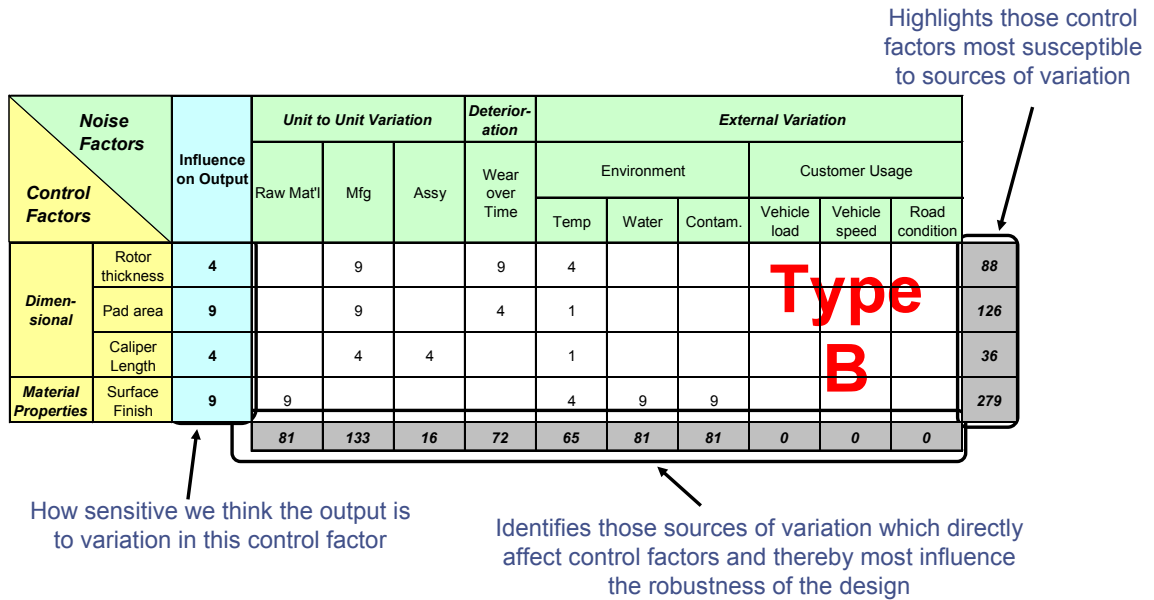

Figure 6.6: A Sample What-Why Table

6.3 Characterise

“Characterise” is the phase in DCOV in which variability in the CTQs is quantified. Combined with mean performance of the CTQs their variability in the presence of noise variation measures the *robustness* of the design, as shown in figure 6.7.

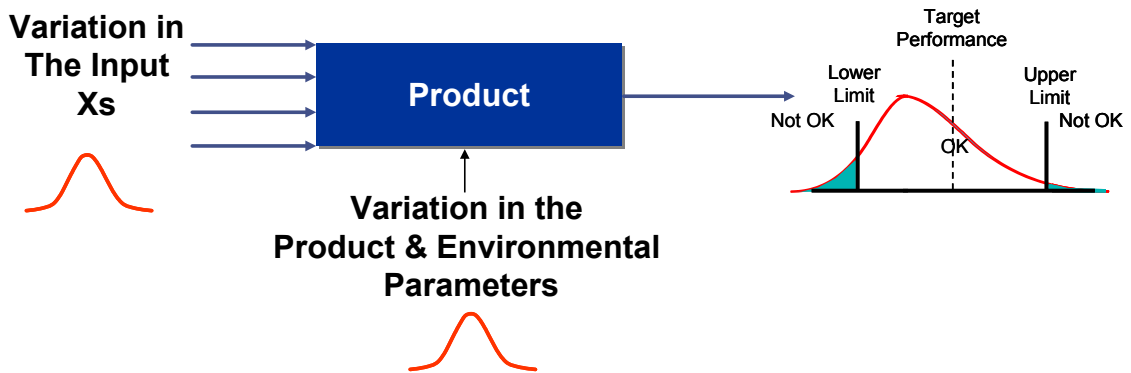

Figure 6.7: Transmission of Variation from Input to Output

There are several methods and metrics available in DCOV that can be used to quantify the robustness of a design. The choice of both method and metric is driven largely by the knowledge and nature of the input variation, but also the speed of the simulation code and the ability to automate the simulation workflow parametrically to calculate the CTQs for which a quantification of robustness is required.

The simplest of these robustness metrics is called “Delta Y” (ΔY): if a change to noise factor is made of a magnitude that is to be expected in the real world we can measure (for hardware) or calculate (for software) the change induced in the CTQ. For any given noise factor j , this is called ΔY_j . In the Delta Y approach to robustness assessment all noise factors are varied by their expected amounts one at a time and all resulting individual ΔY values are summed. If the result is of the same order of magnitude as the tolerance width for the CTQ then the design is unlikely to be robust in practice.

Although not a statistically rigorous robustness metric, Delta Y can be used as both a ‘rough cut’ assessment and to determine which noise factors have the most impact. It can also be used to compare alternative design concepts. An alternative robustness metric (with statistical meaning) is the variance of the CTQ; σ_y^2 . If one has an explicit equation (an *explicit transfer function*) linking the noise factors n and the control factors z to the CTQ of the form $y = f(n,z)$ then one can generate a *variance transmission equation* (VTE) from partial differentiation of the transfer function with respect to the noise factors to approximate σ_y^2 . For example, the VTE derived from a first order Taylor series approximation, for two independent noise factors is:

$$\sigma_y^2 \approx \sigma_{n_1}^2 \left(\frac{\partial y}{\partial n_1} \right)^2 + \sigma_{n_2}^2 \left(\frac{\partial y}{\partial n_2} \right)^2 \text{ Equation 1}$$

Kapur & Feng (2005) gives a more accurate higher order approximation, but often $\sigma_y^2 \approx \sigma_{n_1}^2 \left(\frac{\partial y}{\partial n_1} \right)^2 + \sigma_{n_2}^2 \left(\frac{\partial y}{\partial n_2} \right)^2$ Equation 1 will suffice. Remember that for type A noise, the noise factor and the control factor are the same variable, so one would differentiate with respect to z for such factors. If the explicit transfer function is generated from a designed experiment, rather than from theoretical standpoint, $\sigma_y^2 \approx \sigma_{n_1}^2 \left(\frac{\partial y}{\partial n_1} \right)^2 + \sigma_{n_2}^2 \left(\frac{\partial y}{\partial n_2} \right)^2$ Equation 1 will be supplemented by the model error σ^2 (Myers and Montgomery, 1995).

Another way to obtain an approximation for σ_y^2 when the transfer function exists but cannot be written down explicitly (an *implicit “black box” transfer function*) is via the technique of *simple differences*. This method utilises the first order approximation as in $\sigma_y^2 \approx \sigma_{n_1}^2 \left(\frac{\partial y}{\partial n_1} \right)^2 + \sigma_{n_2}^2 \left(\frac{\partial y}{\partial n_2} \right)^2$ Equation 1, but in the simplified form (again shown for two noise factors):

$$\sigma_y^2 \approx \sigma_{n_1}^2 + \sigma_{n_2}^2 \text{ Equation 2}$$

This simplification is made possible by three assumptions: the transfer function is approximates to linearity over the small region of design space being perturbed by the noise factors, the noise factors are independent and the change in noise factors Δn is defined to be the standard deviation, σ_n . If we represent small (tangible) changes in the noise factors by Δn , rather than the infinitesimally small amount represented by ∂n , then since $\sigma_n^2 / (\Delta n)^2 = 1$, $\sigma_y^2 \approx \sigma_{n_1}^2 \left(\frac{\partial y}{\partial n_1} \right)^2 + \sigma_{n_2}^2 \left(\frac{\partial y}{\partial n_2} \right)^2$ Equation 1 reduces to $\sigma_y^2 \approx \sigma_{n_1}^2 + \sigma_{n_2}^2$ Equation 2, so that σ_y^2 is simply the summation of the squares of the changes in the CTQ (Δy_j) away from its nominal value when each noise factor is varied in turn by one standard deviation. This can be surprisingly accurate, but if desired higher order approximations can be made to refine the estimate. In long running simulation codes with a large number of noise factors k , simple differences can be very efficient, since it requires only $k + 1$ runs.

The final method we shall discuss here is *Monte Carlo Simulation* (MCS), of which there are several variants. The metric we shall focus on is P_c , the probability of conformance for the CTQ. We shall limit our discussion to “simple MCS”, the basic form. MCS requires a transfer function to exist, but it need not be explicit. As we have already said, variation in noise factors causes variation in the response (CTQ). If we can model the probability density function (PDF) of the noise factors through data fitting (or experience or judgment to be begin with), then these distributions can be sampled one at a time at random to produce a random value of the CTQ via the transfer function, as shown in figure 6.8.

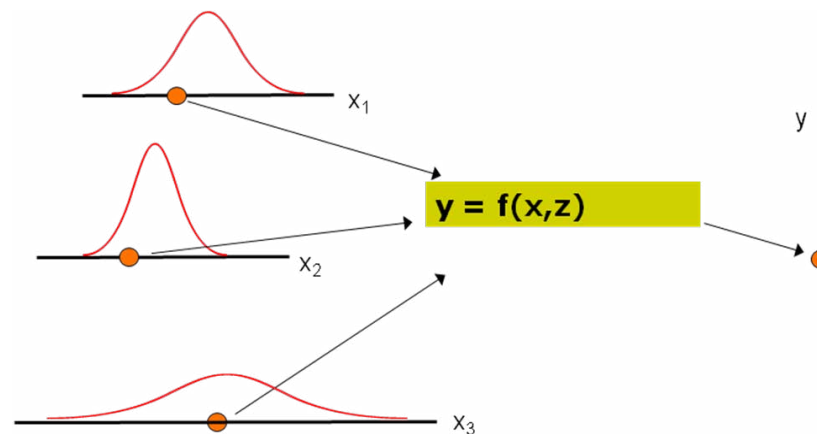

Figure 6.8: Single Random Sample from Input PDFs to Predict Single Result from Transfer Function

This can be repeated many times to produce a probability distribution for the CTQ itself, as shown in figure 6.9.

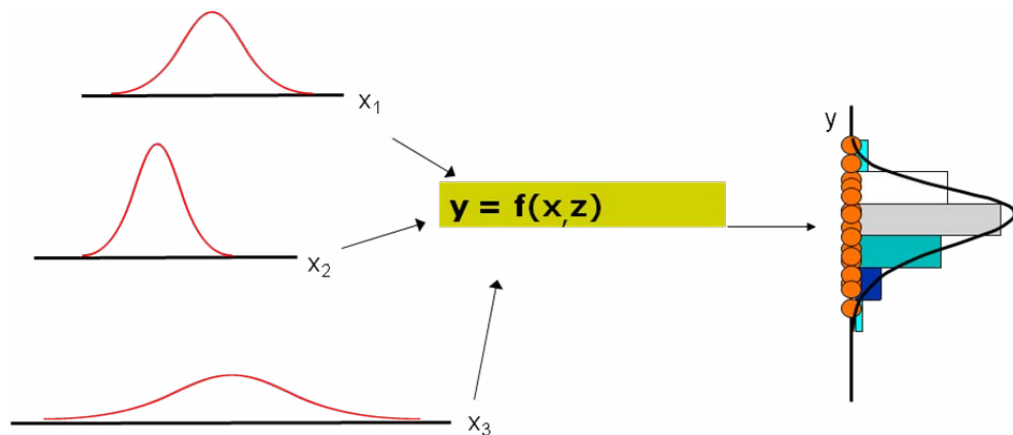

Figure 6.9: Multiple Random Samples from Input PDFs to Predict PDF of Result from Transfer Function

The CTQ data can be fitted to a PDF, which may then be used to compute the probability of conformance, P_c to the specification for the CTQ. The beauty of this method, of course, is that it gives a complete picture of the variation of the CTQ without having to perform mathematics, or use approximations. Disadvantages are that MCS is only relevant to simulations, whereas the previous two methods could also be performed on hardware, and additionally a large number of runs of the simulation code are needed to form a smooth picture of the CTQ variation.

When performing Monte Carlo simulation another important consideration to make is whether or not there is correlation between input parameters. This is important as a strong correlation between any of the factors may have a profound influence on the evaluation of robustness for the design. Clearly if two parameters are correlated then not all combinations of them are sensible. However, applying Monte Carlo simulation in the usual fashion does not account for this – any combination of values is possible and may therefore be selected by the sampling process. Omission of the effects of so-called ‘*covariance*’ between inputs can result in over- or under-estimation of the output variance.

Whether there is under- or over-estimation depends upon the direction of the correlation between the inputs and the signs of their gradients in the design space (also referred to as ‘*sensitivity coefficients*’) at the point in the design space at which we are interested in quantifying the robustness of the design. The *magnitude* of the covariance effect depends upon the strength of the correlation, the magnitude of the sensitivity coefficients and the variance of the inputs themselves. Scatter plots can identify correlations, which can then be statistically justified through hypothesis tests. Figure 6.10 shows an example of a collection of scatter plots (called a ‘*matrix plot*’ in Minitab) that suggest the presence of significant correlations between three pairs of input noise parameters used in the case study described in the next section.

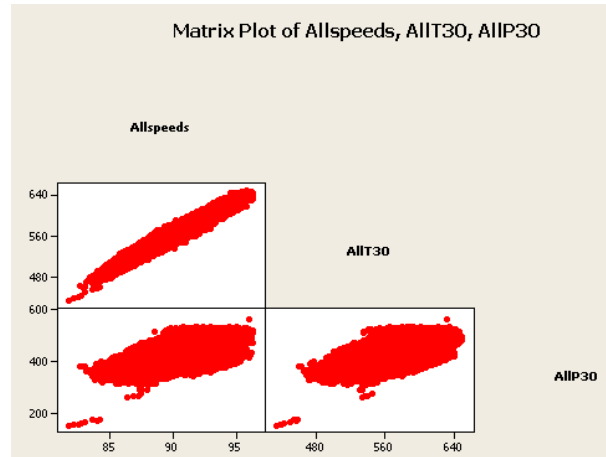

Figure 6.10: Matrix plot showing correlations between input parameters, and statistical quantification of correlation coefficients with statistical significance.

The results shown in figure 6.10 include values for the correlation coefficient, which can have values between -1 and +1 with values closer to these extremes indicating a stronger correlation. The confidence in these correlations is supported by an associated *p-value* (shown below the correlation coefficients). This is the probability of observing such behaviour shown in the scatter plot if there is actually *no* correlation between the variables in reality. A value of 0.000 therefore indicates a very high confidence that the actual correlation coefficient is non-zero.

In many situations the simulations required to be performed are relatively long-running (perhaps taking even days to complete for a single analysis), making MCS impractical. In this instance, either one of the other metrics may be used, or alternatively a *surrogate model* (a *synthesised* transfer function) for the source code can be created.

Using a suitable software package (such as iSIGHT-FD) in conjunction with a Designed Experiment approach a data set can be generated on which to “train” a surrogate model. Depending on the peakedness of the response surface the surrogate models may take the form of Polynomial equations, Kriging models or Radial Basis Functions. Once created, the surrogate model must be validated. This involves testing the ability of the surrogate to predict the value of the CTQs at other, randomly selected, points throughout the design space.

The benefit of these surrogate models is that they run extremely quickly, regardless of the complexity of the model and the number of parameters involved, allowing robustness to be evaluated everywhere in the design space. In fact, through judicious application of DOE in the Define phase, the same model that was used to generate a good nominal design can be re-used for robustness assessment – and even optimisation. An output from Characterise is also an understanding of the *sensitivity* of the CTQs to input variation: which sources of variation contributed most to the observed variation in the CTQs?

In the simplified case depicted in figure 6.11, a single CTQ is determined by two design parameters, each affected by type A noise. In this case, the CTQ is not robust to the expected extent of variation in X_1 and X_2 – and the response is equally sensitive to both sources.

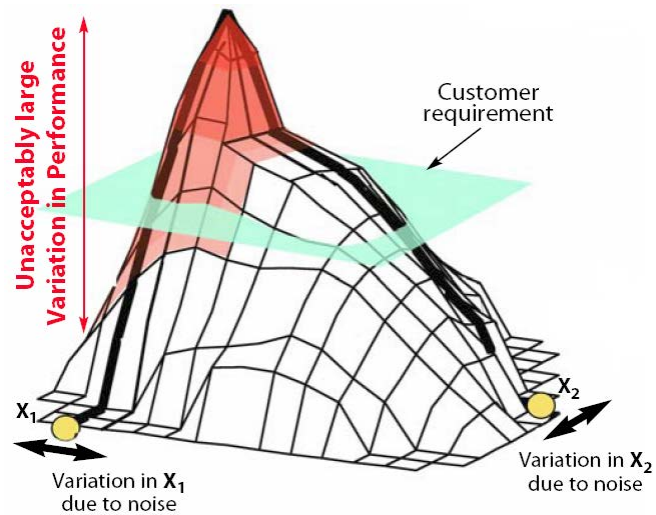

Figure 6.11: A Non-robust, Sensitive Design

6.4 Optimise

Any shortcomings in robustness revealed in the Characterise phase give rise to the need for the Optimisation phase. Alternatively, an “overly robust” design can be made less (but still sufficiently) robust in order to gain benefits in other performance metrics (e.g. reduced weight or cost). This is important to understand, since many, if not all, engineering problems involve satisfying multiple objectives simultaneously. A variety of sophisticated techniques are available to deliver robustness without necessarily incurring cost associated with the common practice of achieving robustness through tightening tolerances or increasing design margin as illustrated in figure 6.12 and figure 6.13 respectively.

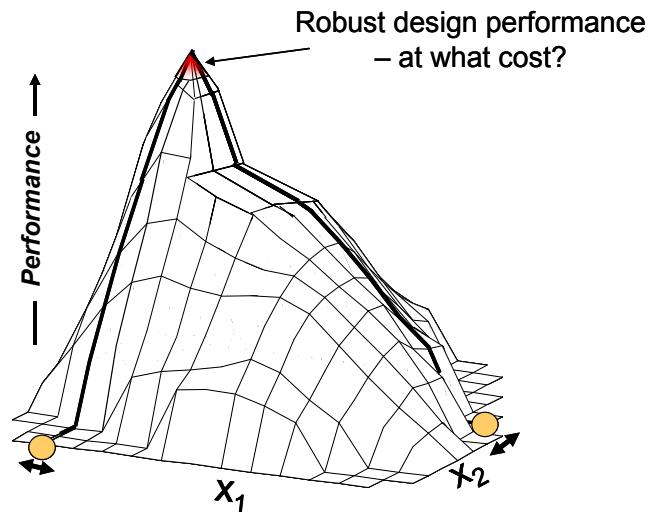

Figure 6.12: Achieving Robustness through Tightening Tolerances

Figure 6.13 illustrates the design margin approach to a problem whereby the strength of the component is insufficient. The design margin solution is to “beef up” the design. Although this works, it increases weight and material cost.

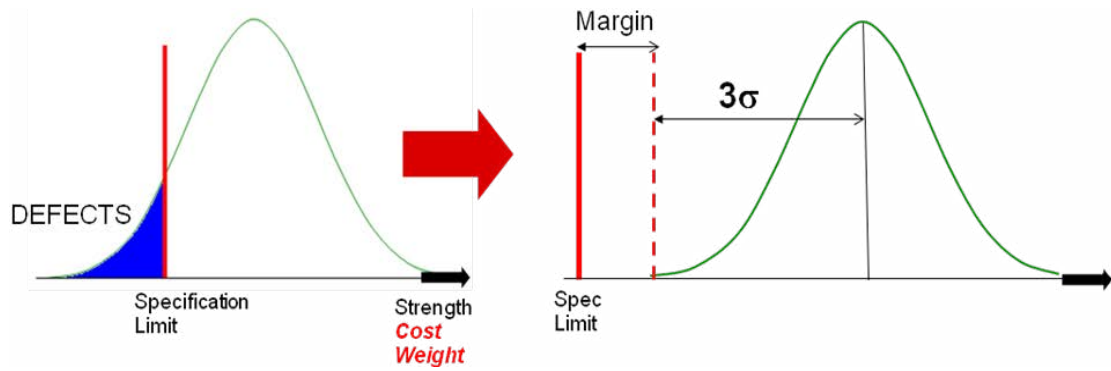

Figure 6.13: Achieving Robustness through Increasing Margin

Parameter Design and Tolerance Design are two strategies that can be applied to deliver a required robustness improvement, either separately or in combination, as part of the Optimise phase of DCOV. Parameter Design is a method to reduce the transmission of input variation to the CTQs by simultaneously adjusting the nominal values of a combination of design parameters. In this strategy the sources and extent of noise variation remain unchanged. Rather we exploit the underlying non-linearity in the relationship between CTQs and design parameters to achieve robustness of the CTQs. Figure 6.14 illustrates such a Parameter Design approach.

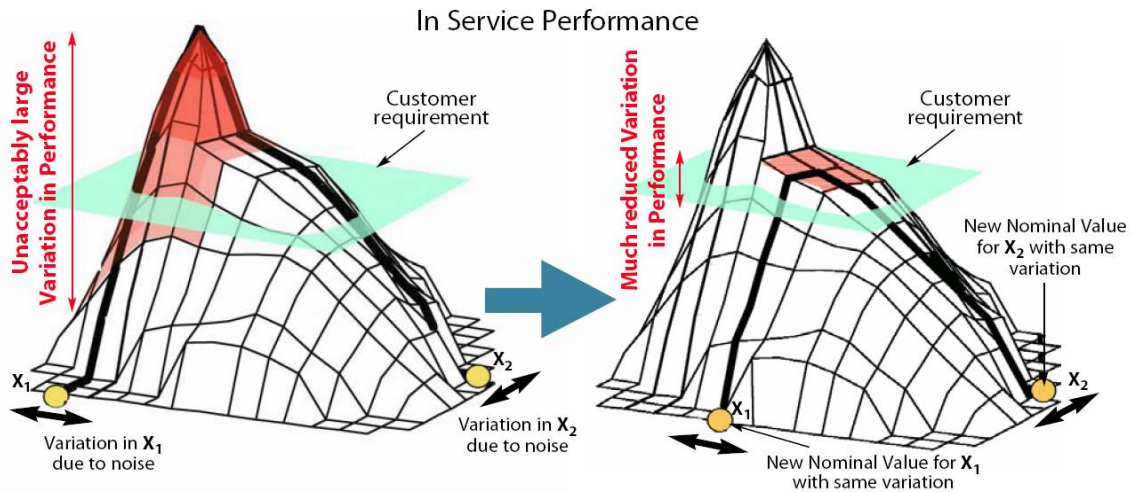

Figure 6.14: PARAMETER DESIGN- changing the nominal settings of the design parameters to achieve design robustness

Tolerance Design is a strategy that modifies the *amplitude* of the noise affecting the CTQs to achieve the same result: improved design robustness (see figure 6.15). However, it is important to understand that this is *not* the same as the simple approach of tolerance tightening; Tolerance Design is achieving the appropriate balance between tightening some tolerances while at the same time loosening others according to the sensitivity of the CTQ to each source of variation. Hence Tolerance Design *can* result in cost savings!

- CTQ highly sensitive to variation in X_1 and X_3 : tighten tolerances
- CTQ insensitive to variation in X_2 : loosen tolerance

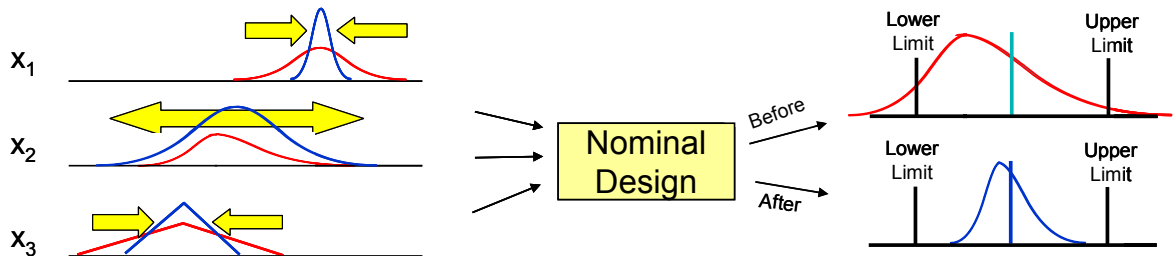

Figure 6.15: TOLERANCE DESIGN- changing the tolerances of the design parameters to achieve design robustness

The results of the Optimise phase are confident predictions of design robustness, an understanding of the drivers of robustness and statistically-based specifications for design parameters. An example of such a specification is shown in table 6.1 (Rowe, 2006).

Target Mean (centre line for Xbar chart)	Target Short-Term Standard Deviation	\pm Tolerance in Units of Measure	Short-Term Capability to which \pm Tolerance Refers (C_{pk})	SPC Subgroup Size, N
20.400	0.500	2.000	1.333	5
Average Range, R_{bar}	Lower Control Limit for Range Chart, LCL_R	Upper Control Limit for Range Chart, UCL_R	Lower Control Limit for Xbar Chart, LCL_{Xbar}	Upper Control Limit for Xbar Chart, UCL_{Xbar}
1.163	0.000	2.460	19.730	21.070

Table 6.1: Statistically-based Specifications for key design parameters

Here we can see that rather than the traditional “goalpost” specifications of a nominal with plus/minus tolerancing (20.400 \pm 2.000 in the above case), we have a statistical process control specification defining a required process capability, C_{pk} . This gives manufacturing a gauge by which to better assess actual ongoing process performance *manifestly linked* to design performance via the analysis chain created during the DFSS process – something that is not possible with traditional tolerancing!

6.5 Verify

The Verify phase assures us that the predictions made during Characterise and Optimise are both *accurate and trustworthy*. This means collecting production, hardware testing and in-service data in order to perform statistically-designed tests of confidence that the assumptions used to predict robustness were correct. The Verify phase also assures us that the statistically-based specifications are being consistently achieved. This involves monitoring the process and comparing to the control limits and target lines for Statistical Process Control (SPC) charts defined in the Optimise phase, an example of such is shown in figure 6.16.

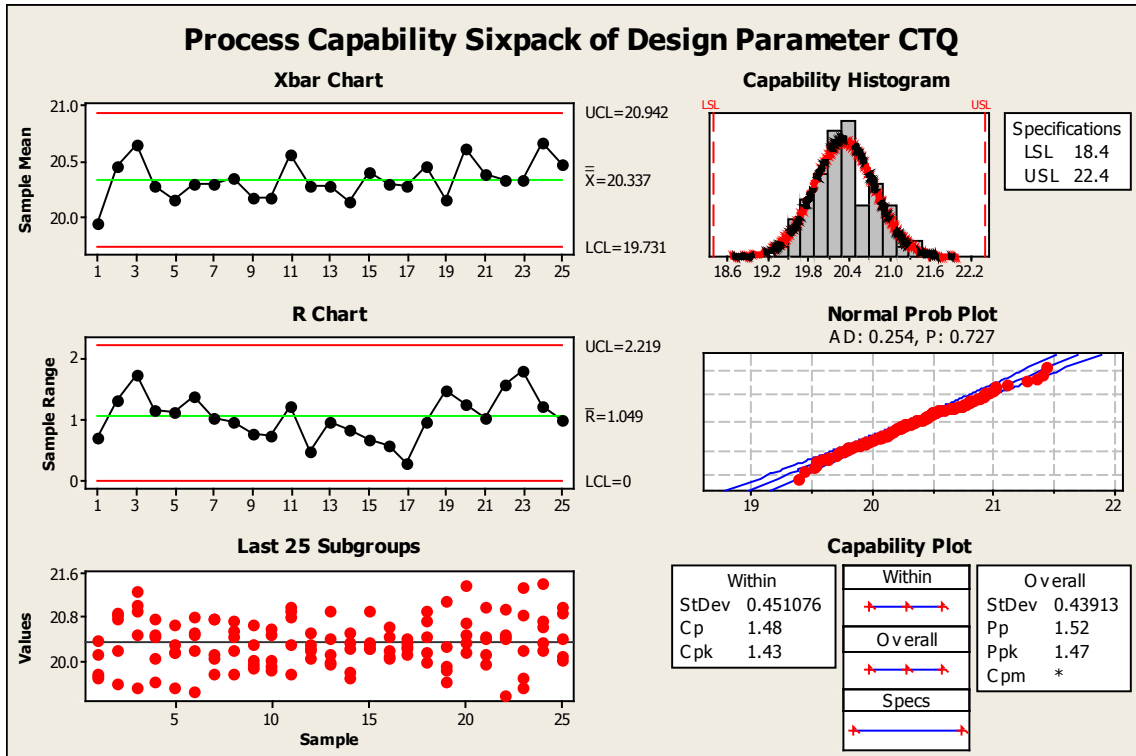

Figure 6.16: Statistical Process Control chart to demonstrate conformance to statistical design specifications (Minitab "Capability Six Pack")

In figure 6.16, we can see that the process is *in control and exceeding the required capability* of $C_{pk} = 1.33$. This data can be fed back to design, along with data for all the other CTQs for the system so that we can re-assess the robustness of the design on an on-going basis.

6.6 Application of DFSS to a HP Turbine Disc

6.6.1 Introduction

Gas turbines are highly complex systems with many competing and increasingly onerous requirements, for example: lower emissions, improved availability and lower running costs. These “high level” requirements translate in to more specific design targets, meaning that future designs will be driven to be lighter in weight, operate at higher and higher temperatures and speeds to reduce fuel burn, and at the same time maintaining acceptable life and overall performance characteristics. However, it is important to recognise that all of these requirements must also be *robust* (insensitive) to the effects of variation (“noise”) to which the gas turbines will be subjected throughout their lives.

This section shows how the DFSS DCOV process was tailored to suit the design process of a specific HPT disc, which will provide a template for a generic robust design process for similar components that will produce better designs faster in the future. Large aero gas turbine engines built around the three-shaft design concept (as depicted in figure 6.17) are unique to this company and were introduced with the entry into service of the first of the RB211 series in the 1970s. This basic architecture continues still in today’s Trent family of high-thrust, high-bypass engines powering the new generation of wide-bodied jets from Airbus and Boeing.

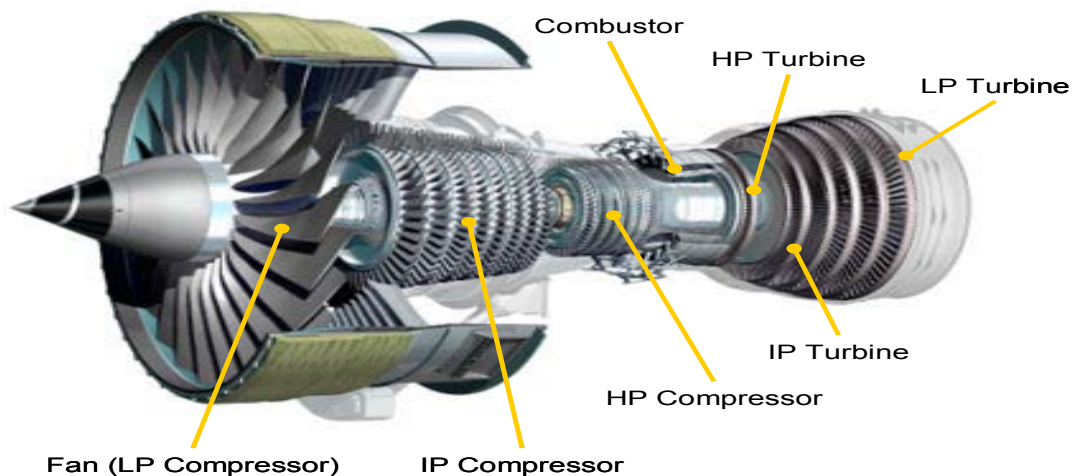

Figure 6.17: Schematic of a Gas Turbine showing Major Subsystems

The engineering principle involves low, intermediate and high pressure “spools” (LP, IP and HP respectively), each consisting of a number of compressor and turbine stages, with each spool mounted on independent shafts that run at different speeds. In this system the principal functions of the HP Turbine disc is to maintain the correct location of the set of HP Turbines blades in the hot gas path exhaust from the Combustion system and to transmit the power absorbed from the hot gas by the blade through to the HP shaft which then drives the HP Compression system.

6.6.2 Define

Because the design style for the HPT disc is generally heavily constrained by both the engine and turbine sub-system architectures, the standard approach to QFD is not well suited in this instance: there is less scope for innovation in this component, hence QFD1 was bypassed in favour of a more pragmatic approach that directly linked the prioritisation of requirements to the functional definition of the HPT disc through AHP, as shown in figure 6.18.

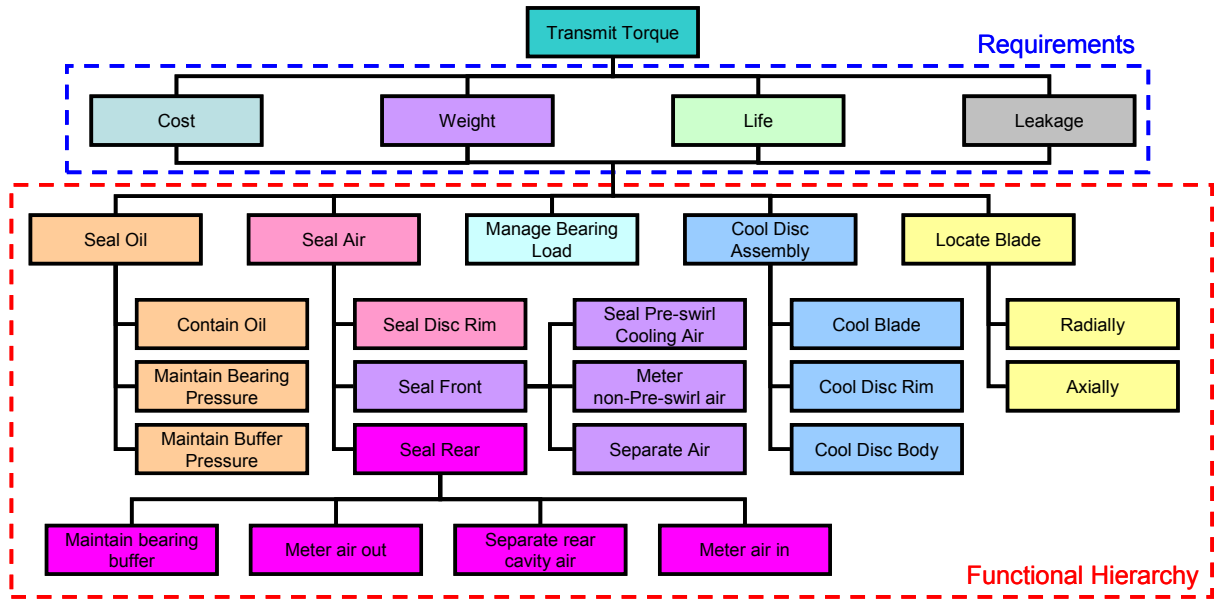

Figure 6.18: Hierarchy of Requirements and Functions for the Disc used in AHP

The result from AHP was then be used to define the importance of the Functions within QFD2, which, in conjunction with understanding the relationship to functionality by each individual design feature, determined the *relative importance of features*, as shown in figure 6.19.

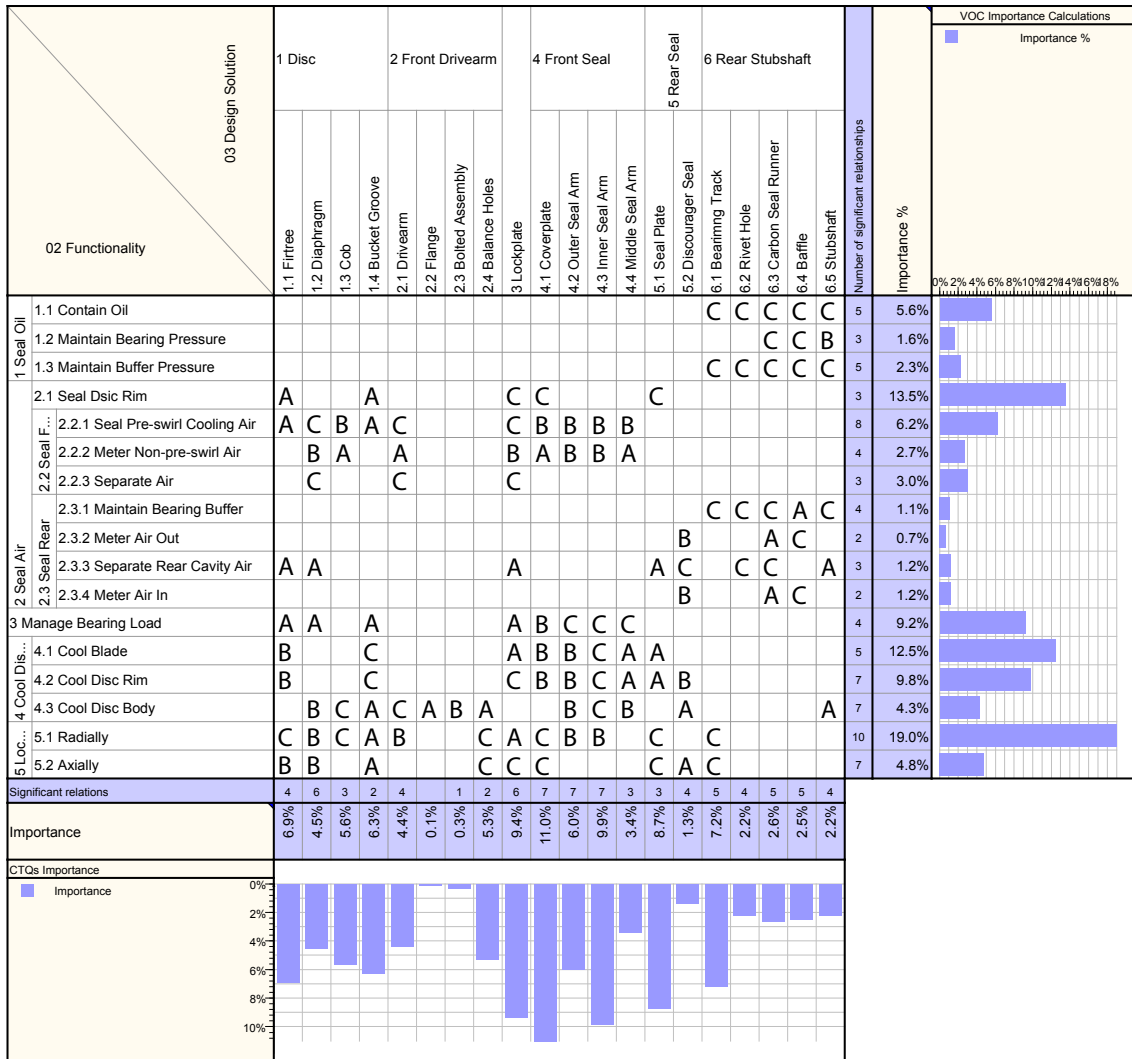

Figure 6.19: Completed QFD2 Showing Functional Importance, Relationship between Features and Functionality and Resultant Feature Importance

It should be noted that the importance of features resulting from QFD2 does not necessarily give us the complete picture as to what should be the focus of any DFSS project – adding *practicality* and *opportunity* to this importance can give us valuable extra insight. Such a rationale might be described as follows:

1. Outputs of the analysis are able to be modelled?
2. Analysis codes involved (including time for setting-up to run) run quickly?
3. Is there flexibility in parameters to determine the nominal design (design freedom & lead time)?
4. Manufacturing variation and other potential sources of variation can be collected?

5. High risk of poor service performance and/or manufacturing problems?

6. Significant cost implications of changes to the design after hardware has been committed to, if you get the design wrong?

Taking each of these criteria in to consideration and combining them with the importance rating from QFD2, a sub-set of features were down-selected for further study using the DFSS methodology; other features being treated as “business as usual”. For simplicity, we shall continue on and discuss only a single feature (the disc *firtree root*) from this down-selected list.

The firtree root is the name for the style of fixing that locates a turbine blade radially to the disc at the rim. Axial retention is maintained by another feature, the “lockplate”. The name firtree derives from the distinctive shape that resembles a fir tree: radial location is maintained through a series of inter-locking “teeth” as shown in figure 6.20. Even on this single feature of the disc, it is clear that there are many factors – including the number of teeth on the firtree and the geometry of each individual tooth – that will affect some aspect of the fitness for purpose of the design to some degree or other.

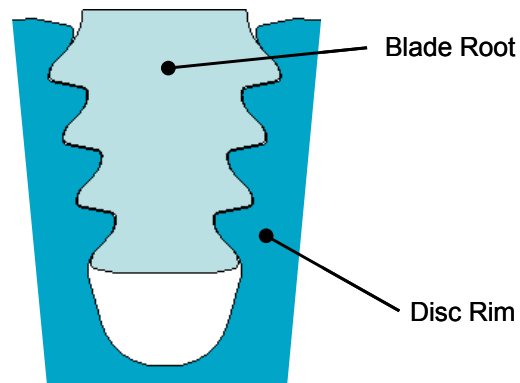

Figure 6.20: A Schematic of a Firtree Root

In figure 6.21 we see a breakdown for likely sources of variation that might affect one of the CTQs for the firtree: *Life*. This information, combined with a detailed description of the firtree geometric parameters, is used to create a specific P-diagram, the generic form of which is shown in figure 6.5. Similarly a specific What-Why Table for the firtree (see figure 6.6 for the generic form) was produced that identified all key parameters that were built in to the automated, parametric Finite Element Analysis (FEA) model that was then employed in all further simulation.

Following the “DOE roadmap” as defined in figure 6.4, a *screening design* was used to reduce the number of parameters for the firtree that would be taken forward in further study. The screening design was in this case a *Resolution V* 2-level fractional-factorial design. It is more usual for screening designs to be highly fractionated (*Resolution III*) 2-level fractional-factorial designs, but in this instance analysis time allowed a more powerful screening process to be employed. This avoided the considerable *confounding* in the Resolution III design, allowing a more reliable choice of important factors to be made (see Myers & Montgomery (1995) for more on the resolution of a fractional factorial design).

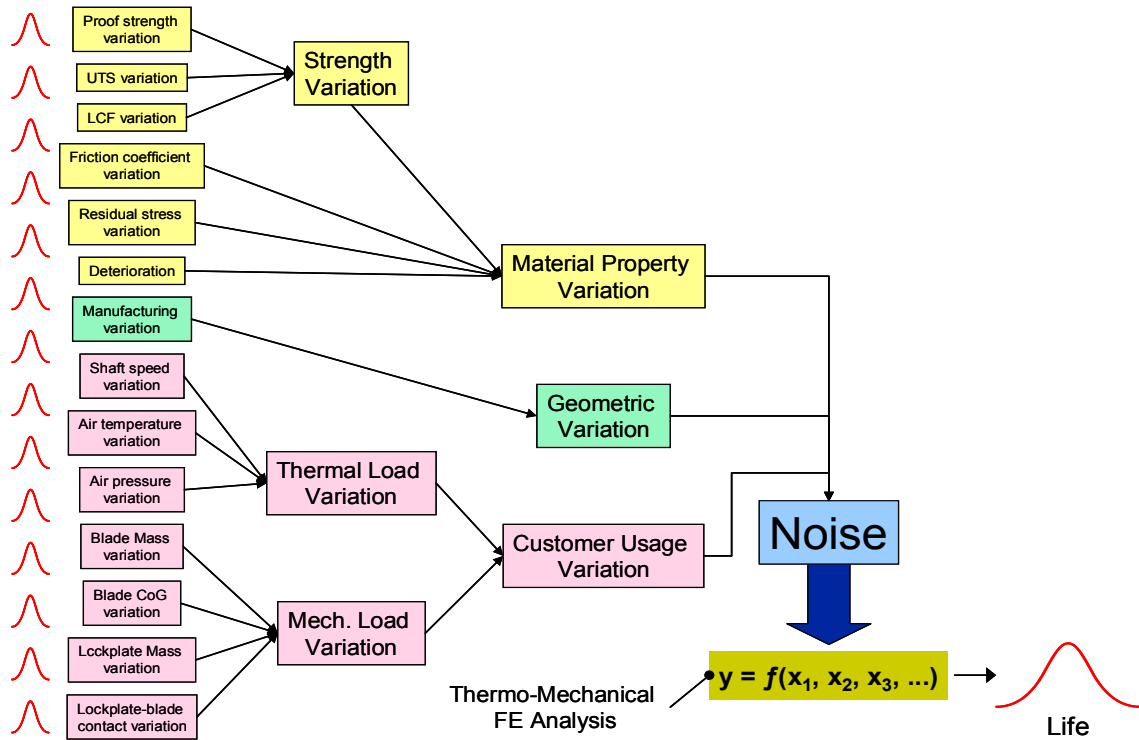

Figure 6.21: Key Variational Inputs for Firtree

Following this screening process, a 3-level face-centred *Central Composite Design* (Myers & Montgomery 1995) was performed on the reduced set of factors in order to create a *Surrogate Model* that was suitable for making predictions about the behaviours of other combinations of factors that were not explicitly exercised as part of the experiment. This is important because, by their nature, Designed Experiments only look at “extreme” combinations at the outer bounds of the design space, and as such are not likely to result in a combination of factors that lead to the best design configuration.

An important part of the surrogate modelling process was the validation step (see the DOE Roadmap, figure 6.4). This involves testing the model’s predictive ability at points in the design space other than those used to train the model. These additional test points allow us to compute *residuals*: the differences between values predicted by the surrogate model and the actual values produced by the simulation code. Figure 6.22 shows the resultant residuals for the final Kriging Model that was chosen as the best predictor for the firtree in this instance.

Differences between surrogate and actual values are of course to be expected, but we are checking for “fitness for purpose”: the residuals should be well-behaved, demonstrate that the surrogate follows the general trend of the simulation code data, and is equally good at predicting values throughout the design space. In these respects, as can be seen in figure 6.22, the surrogate model is more than adequate. Other model forms (Polynomial and Radial Basis Functions) were of poorer quality.

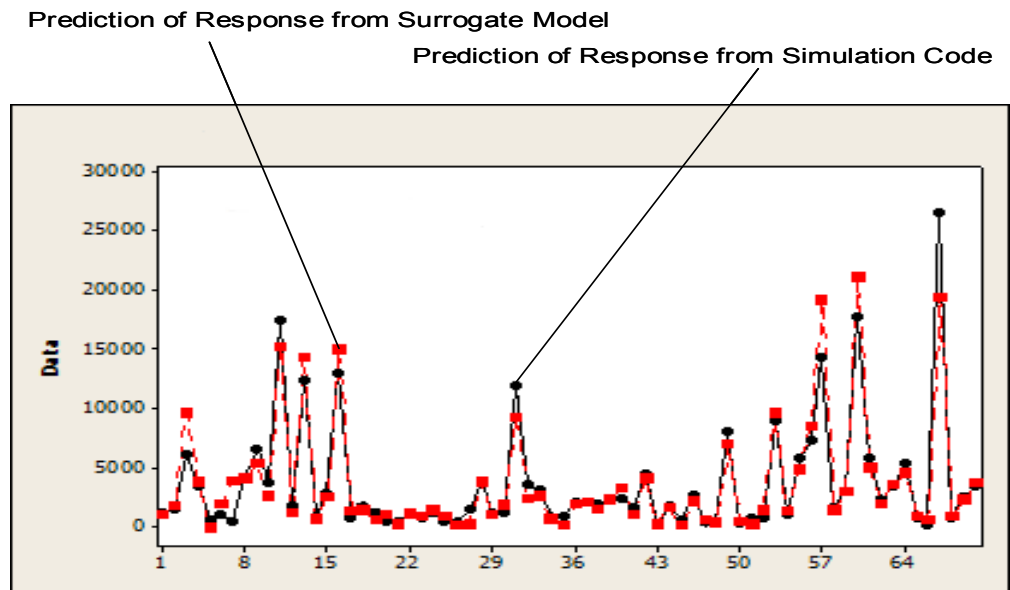

Figure 6.22: Residuals of Predicted versus Actual values for Surrogate Model

A 3D visualisation of this Kriging model, produced in iSIGHT-FD, is shown in figure 6.23 for a single CTQ plotted against two of the input factors.

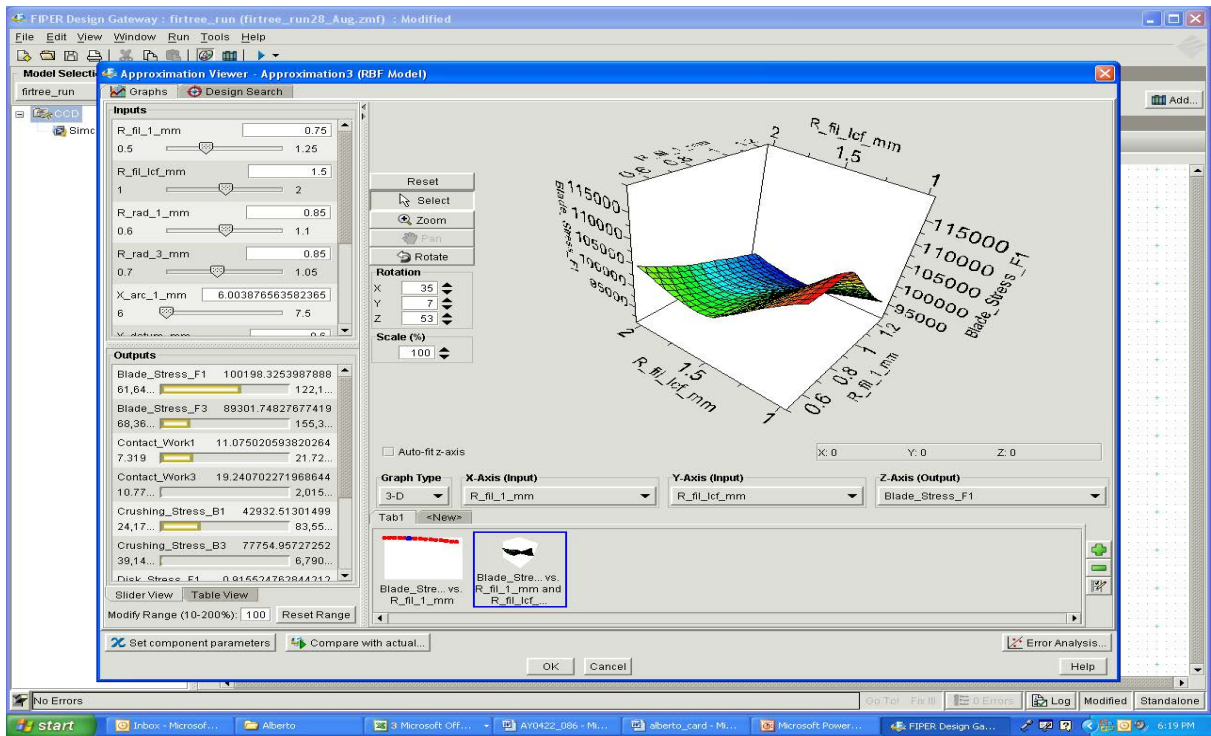
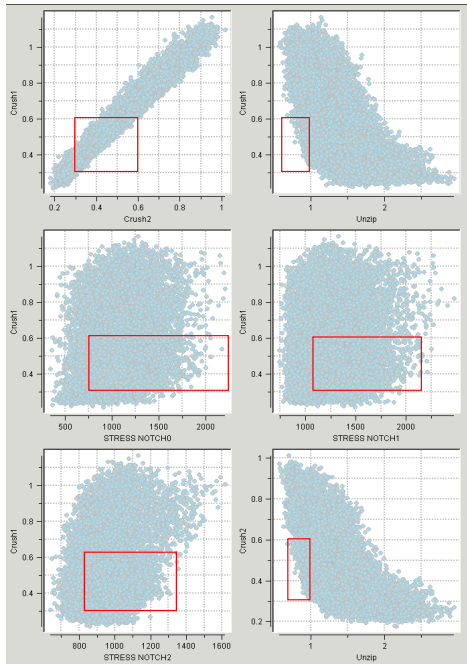

Figure 6.23: 3D plot of Firtree Surrogate Model

The creation of a surrogate model now allows us to efficiently explore the available design space in order to find a good nominal design. It is not necessary at this point in the process to employ automated design optimisation. It is in fact simpler (and possibly more reliable) to define a further Designed Experiment that will densely populate the available design space in an unbiased manner – a simple *Latin Hypercube* (space filling) design is well-suited to this purpose. The results of such an exercise can be seen in figure 6.24.



- 10,000 executions of Surrogate Model to populate Design Space
- Each individual point on the adjacent scatter plots corresponds to a “candidate design”
- Axes correspond to pairs of the six CTQs relevant to the firtree
- Feasible designs are contained within the rectangular regions shown – these are design that satisfy all constraints on the CTQs

Figure 6.24: Results of Design Space Exploration using Surrogate Model for Data Mining

In iSIGHT-FD (see reference), it is possible to employ graphical data mining techniques as shown in figure 6.25. The upper chart in this figure allowed the user to interactively select any set of values for the design parameters, for which the corresponding values of the CTQs were automatically highlighted in the lower chart as shown. Furthermore the values of CTQs displayed could be filtered in order to isolate only those designs that are feasible. This then enabled the user to make an informed choice of the best nominal design. The selected design point was then validated by running the selected combination of design parameters through the simulation code in order to prove that the design gave a similar level of performance for the CTQs as was predicted by the surrogate.

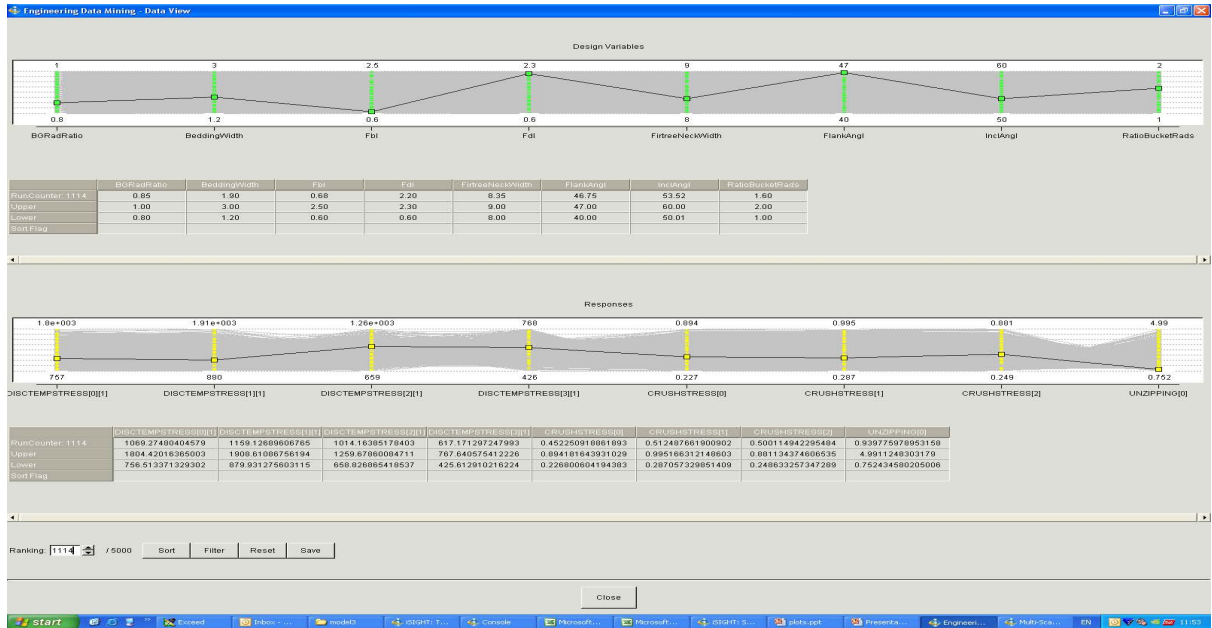

Figure 6.25: Graphical Data Mining of Candidate Designs

6.6.3 Characterise

Following the selection of the nominal design the next phase of the DFSS process is to characterise the robustness of the design. A precursor of this was to statistically model the important noise factors identified in figure 6.21 using real world data where available (and valid engineering assumptions otherwise). An example of a statistical model fitted to data is shown in figure 6.26 for one such source of noise. In this case a ‘beta’ distribution was the best choice of model. A combination of Minitab (see Reference) and Crystal Ball™ (an Excel plug-in; see Reference) was used to model the data.

As stated previously it is important to account for correlations between sources of noise, so as to correctly calculate the design robustness. For the firtree, where sources of noise were shown to be correlated by examining the data in Minitab, Crystal Ball™ was used to account for the correlation by creating a sample “look-up table” of correlated values for each pair of correlated noises. This look-up table was in turn used in iSIGHT-FD by randomly selecting a set of correlated values from the table, thereby enabling the correlations to be correctly accounted for in the robustness analysis. From iSIGHT-FD version 3.0 onwards, such correlations can be directly input, thereby eliminating the need for this step.

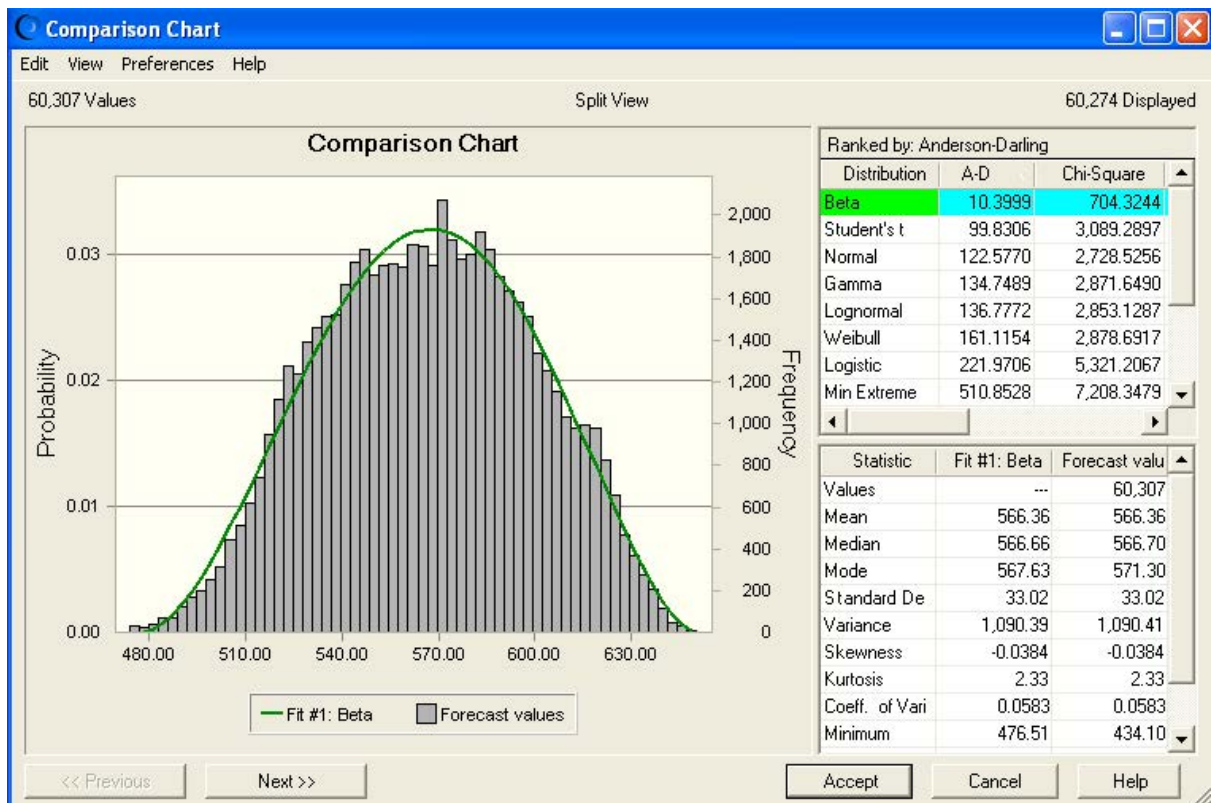

Figure 6.26: Statistical Model of Variation based on Real-World Data

Because a validated surrogate model that covered the whole of the design space had already been created, it was possible to evaluate robustness using Monte Carlo Simulation and to choose P_c as the robustness metric. In this case, since the target value for P_c was 0.999 or greater, the robustness assessment shown in table 6.2 meant that the chosen nominal design was not, in fact, robust! Traditionally, this may not have been recognised until much later in the design life cycle.

Robust Objectives				
CTQ Name	Mean Value	Std. Deviation	Sigma Level	Probability of Success
DISCTEMPSTRESS[0][1]	1021.582641	49.51000497	0.428	0.3314456301
DISCTEMPSTRESS[1][1]	1423.35273	49.92883437	0	0
DISCTEMPSTRESS[2][1]	1068.281039	50.48848412	0.111	0.08812238569
DISCTEMPSTRESS[3][1]	495.7176535	10.61831907	8	1
DISCLIFE[0]	6.944021283	0.4042382085	6.64	1
DISCLIFE[1]	4.638194428	0.2757581947	1.6	0.8899790288
DISCLIFE[2]	6.60538864	0.3524712057	6.64	1
CRUSHSTRESS[0]	0.3074143453	0.01448322976	8	1
CRUSHSTRESS[1]	0.3547404355	0.007460720589	8	1
CRUSHSTRESS[2]	0.322618089	0.006312710367	8	1
UNZIPPING[0]	0.9551183615	0.02980023109	1.84	0.9339771396
UNZIPPING[1]	0.9486001684	0.02991357434	2.02	0.9571270244

Table 6.2: Results of Robustness Assessment on Nominal Design

6.6.4 Optimise

Since the current nominal design was not robust, it was necessary to identify an alternate solution that met the twin requirements of feasibility and robustness for all CTQs simultaneously. Using the population of previously identified feasible designs and the same surrogate model, the robustness of each of the many alternative feasible candidates was calculated and evaluated in order of preference (based on nominal performance) against the requirement of achieving $P_c > 0.999$ until a robust option was found.

This is an implementation of the **Parameter Design** approach since we are not altering input variation, only choice of nominal design parameters. At this stage in the design life cycle, these changes are 'free' since hardware has not been committed to. Such a sequential approach to determining nominal designs and thence robustness is preferable from a computational standpoint, since – even when employing a surrogate model – the calculation of P_c from a Monte Carlo Simulation is not trivial. It is logical to identify the candidate subset of feasible nominal designs and *then* calculate robustness only for these designs rather than calculate robustness of all designs irrespective of their feasibility.

In fact, the resultant design selected through this methodology was sufficiently robust to obviate the need for further robustness improvement through applying Tolerance Design. Similarly, as the final design was sufficiently robust, but not overly so, there was no cost advantage to be gained from loosening tolerances in this instance.

6.6.5 Verify

At the current time, the HPT disc design under discussion is still purely “digital” and has not yet been manufactured. This means that although the Verify phase is planned, results will not be available until some time in the future as part of the engine development programme.

6.7 Conclusions

This paper has set out not only to clearly describe a practical implementation of DFSS using the DCOV methodology, but also to highlight the demonstrated benefits of the approach, specifically:

- A more thorough exploration of the design space is achieved than would otherwise be possible. This means that many more feasible options are made available to the designer for evaluation, enabling a design solution to be chosen that best meets the competing demands of low cost and *consistent* high performance.
- A quantified estimation of P_c (probability of conformance) for the design – hence greater confidence in the consistency of delivery for actual in-service performance.
- The application of Parameter Design – rather than traditional “Tolerance Tightening” – to fix robustness issues thereby avoiding extra cost and pain.
- Much of the data and associated models of variation, the automated analysis chain and surrogate models, QFD matrices, P-diagrams, What-Why tables, etc. used in this project can be re-used in future projects where a similar design concept is to be evaluated in a new application – thereby further speeding up design cycle times *and* improving quality.
- Through its team-based activities such as QFD, P-diagram and What-Why table creation, development of a multi-disciplinary analysis chain, DFSS promotes better cross-functional cooperation leading to a higher overall awareness of all design issues that exist. This improves the quality of decision making throughout the design process.
- Adapting individual methods and tools that form part of the overall “DFSS toolkit” to the needs of the engineering task at hand (in particular tools such as QFD and DOE) so they are less burdensome in application but still highly beneficial in progressing the engineering design process and hence encourage its adoption as a framework within which to solve engineering problems.
- With the computational power that is available today, it is possible to achieve design optimality (including robustness) through fully automated “black box” optimisation techniques. However, the more “hands on” approach as described in this paper is often more desirable, since it imparts a greater knowledge of the design space and the factors that influence both nominal performance and robustness to the design team.

6.8 References

iSIGHT-FD, For more information on iSIGHT-FD and how to contact the Engineous team, visit their web site at <http://www.engineous.com>.

Kapur, KC., & Feng, Q 2005, 'Integrated Optimisation Models and Strategies for the Improvement of the Six Sigma Process', *International Journal of Six Sigma and Competitive Advantage*, vol. 1, no.2

MINITAB, For more information on Minitab and how to contact the Minitab team, visit their web site at <http://www.minitab.com>.

Myers, RH., & Montgomery, DC 1995, *Response Surface Methodology, Process and Product Optimisation using Designed Experiments*, Wiley Interscience, 1995

Qualica, For more information on Qualica and how to contact the Qualica team, visit their web site at <http://www.qualica.de>.

Rowe, PG 2006, 'Setting Statistical Specifications for Critical To Quality Characteristics', *International Journal of Six Sigma and Competitive Advantage*, vol. 2, no.1.

Saaty, T 1999, *Decision-Making For Leaders; The Analytic Hierarchy Process For Decisions In A Complex World*, RWS Publications

7 Creating a Product Development Process Integrating DFSS at XYZ

Torben Hasenkamp

Chalmers University of Technology, Division of Quality Sciences

Department of Technology Management & Economics

SE-412 96 Gothenburg (Sweden)

Email: torben.hasenkamp@chalmers.se

Annika Ölme

Product Development & Engineering Platforms of XYZ

Gothenburg/Sweden

Abstract

The purpose of this study was to show why and how XYZ implements Design for Six Sigma in order to provide both academicians and managers with an example that invites further discussion about implementation of the methodology and contributes to clarifying the concept itself. XYZ's approach to implement Design for Six Sigma is presented including the background and reasons that may have led to it. The approach is further compared with literature available concerning implementation of Design for Six Sigma. There is no single approach how Design for Six Sigma should be implemented; instead the strategy should depend on the respective circumstances. Project-driven implementation is compared with integrating the methodology into the product development process and an example of how such a development process may look like is presented. As many corporations are struggling with implementing Design for Six Sigma a case description will be of value. The rather tool-based literature on the methodology should benefit from works that direct attention to implementation issues. Altogether dissemination of Design for Six Sigma will benefit from shared experiences and discussions on implementation strategies.

Keywords: Design for Six Sigma, implementation, product development process, integration

7.1 Introduction

Triggered by ever increasing customer demands in terms of quality and costs throughout the past decades engineering improvement initiatives have moved upstream in the product lifecycles from inspection over production to product development stages. Examples of current initiatives focusing on development stages are Axiomatic Quality (El-Haik & Suh 2005), Variation Risk Management (Thornton 2004) and Design for Six Sigma (Creveling et al. 2004). The latter can be taken as a continuation of the Six Sigma movement lifting its efforts upstream to design stages. Sigma, being a statistical representation of variation, quantifies the process performance at selected quality measures, where a process is considered Six Sigma capable when its performance causes no more than 3.4 Defects per Million Opportunities (DPMO).

XYZ (company name changed due to confidentiality agreement) – the knowledge engineering company offering solutions related to bearings and seals – defines Design for Six Sigma (DFSS) as “*a development methodology for new products, services and processes – proactively securing solutions to fulfil six sigma conditions.*” There are different options of implementing DFSS. Unlike Six Sigma, which is commonly driven via Define-Measure-Analyse-Improve-Control (DMAIC) projects, in DFSS there have emerged a number of stepwise processes all in the style of the DMAIC procedure. Examples of such DFSS procedures are Identify-Define-Develop-Optimize-Verify (Chowdhury 2002), Identify-Characterize-Optimize-Verify (Yang and El-Haik 2003) or Define-Characterize-Optimize-Verify (Soderborg 2004); another option, however, is to integrate DFSS into the product development process (PDP). This already indicates that DFSS is not as clearly defined as Six Sigma, as stated by e.g. Berryman (2002).

The lack of clarity concerning DFSS and a focus of most descriptions on tools offer two possible explanations of the fact that many companies are struggling today with implementing DFSS (Gremyr 2006). Companies simply do not know where and how to start and how to continue their DFSS efforts in a structured manner. In line with this Cole (1999, p.151) cites one leading Fortune 500 executive responsible for quality who even talks about “*the secret of quality improvement to be in its implementation and execution [meaning that] one could talk openly and not greatly fear that a competitor could quickly copy one’s efforts.*” This paper treats this issue and describes both why and how XYZ systematically deals with the implementation of DFSS including the reasons for integrating the methodology into the PDP.

The next section describes the reasons that finally led to the decision to implement DFSS at XYZ. Thereafter the requirements on a new PDP are presented followed by presentations of both the process itself and the infrastructure for DFSS within XYZ. The paper concludes with a discussion and conclusions that may ignite further discussions contributing to an increased understanding and an accelerated dissemination of DFSS or its core values.

7.2 XYZ and the Need for Design for Six Sigma

Describing the driving forces that, ultimately, have led to the decision for a determined DFSS commitment a brief digression will be helpful. Celebrating its 100th anniversary (1907 – 2007) the roots of XYZ are deeply engrained with Sven Wingquist and his invention of the first self-aligning ball bearing. Being plagued by recurring weaving machine breakdowns due to bad quality of the machine bearings – note that the XYZ predecessor company was active in textile industry – he went about to develop a ball bearing capable to withstand misalignments of the shafts that led to the costly machine breakdowns. Even though quality of ball bearings at that time was bad they were goods in short supply and for this reason his invention promised substantial profits resulting in the establishment of XYZ in 1907. Quality and technical development are still today distinguishing elements of XYZ’s business strategy which aims at offering not merely bearings or sealing products but instead complete system solutions related to the five dedicated core competences, namely seals, bearings and units, lubrication systems, mechatronics and services, as illustrated in figure 7.1.

This strategic commitment for complete system solutions – thereby the term “knowledge engineering company” – calls for a more sophisticated method of gathering the customers’ needs and problems. It becomes crucially important to fully understanding those needs and problems in order to be able to offer and develop the right solutions. In other words, much more emphasis needs to be placed on understanding the customers’ business with its needs in order to be able to realize the vision to “equip the world with XYZ knowledge”.

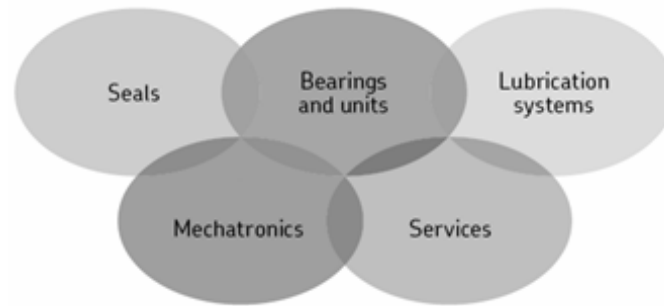

Figure 7.1: The five core competences of XYZ

Furthermore, having implemented Six Sigma in the late 1990's, it appears to be a natural step to continue with DFSS lifting the Six Sigma ambitions upstream to development stages. As tools connected to the DFSS methodology have been around for decades, they have been in use here and there within the XYZ organization. Now a determined commitment is required in order to make DFSS the way products are developed at XYZ – in all divisions and parts of the whole organization.

However, when taking a closer look at the more operational motivations for the self-enjoined obligation to work with DFSS, more concrete reasons can be named in the form of corporate goals that are briefly described in the following.

- **Avoidance of failure modes**

The company wide Six Sigma program has proven its worth mainly by eliminating failures or improving processes, preferably in production stages. Now it has been realized that, by implementation of DFSS, many failure modes can be prevented. In other words, improved (DFSS) product development performance will avoid many potential failure modes from occurring.

- **Increase of engineering effectiveness**

Many tools of the DFSS methodology, such as Quality Function Deployment (QFD) or the Kano model, are contributing to front-end load the PDP with the purpose of achieving design stability as early as possible. By achieving design stability earlier an increase of engineering effectiveness is believed to occur – all according to the motto “cheap early changes to be preferred to expensive late ones”.

- **Reinforcement of development process**

Design for Six Sigma aims at improving PDP performance by e.g. directing the focus of efforts to the most essential aspects in a systematic way from the very beginning of development projects. This was found to offer room for improvement at XYZ.

- **Stimulation of innovation and creativity**

The goal is to stimulate innovation and creativity by utilizing DFSS features, such as Voice of customer tools and functional thinking in combination with creativity tools such as TRIZ. Functional understanding of customer needs enables creativity and opens the door to new and innovative solutions. The design is generated from functional requirements with an open mind and not predetermined at development start: Needs model the design – design does not model the needs.

- **Increase of customer satisfaction**

A fundamental intention of DFSS is to increase customer satisfaction. On the one hand this is achieved by a stronger focus on the customer per se and the customer needs and on the other hand by focusing on robustness and thereby minimizing the variation of product performance around target performance values. In fact, some customers are emphatically requesting the use of DFSS in development work at XYZ.

7.3 Integration vs. Project-Driven Design for Six Sigma

As outlined in the introduction there are two fundamentally different ways of implementing DFSS in a company. Either you drive DFSS in projects as is the case with the traditional DMAIC Six Sigma project approach, or you integrate the methodology into your PDP. In the following we will elaborate on the circumstances and reasons that led to the choice made at XYZ to integrate DFSS into the PDP. Again, it is helpful to start out with a brief digression.

Over the years the company grew besides its organic growth via acquisitions and mergers of different companies under the lead of XYZ. Those companies who joined the XYZ group over the years, brought along their own ways of developing products. Today the XYZ group has seven major development centres developing solutions for either the industrial or the automotive division. Each of those development centres brought along its own procedure and tradition for developing products. This variety implicates various kinds of challenges related to e.g. communication between the centres or coordinative issues especially in the case of cross-divisional projects. Consequently, it has been decided to create one common PDP in order to release synergies and ensure a common language within the domain of product development. Due to the diversity of XYZ's product and service portfolio this development process must be sufficiently generic to be applicable to all business divisions of the XYZ group, namely the automotive, industrial and service division. In addition, it should comply with XYZ's distinctive devotion for quality and thus correspond to up-to-date standards in this respect. To accomplish this, it has been chosen to integrate the DFSS methodology into the new PDP.

Besides, there are also other reasons for integrating DFSS into the development process – as opposed to implementing DFSS in a project-organized manner. First, XYZ draws a clear distinction between Six Sigma and DFSS; while Six Sigma projects are primarily initiated to improve something and thus focus on e.g. production issues or already developed products, DFSS shall be applied systematically in all new product development projects. In fact, the long-term goal is that DFSS shall become the common way products, processes and services will be developed at XYZ. In other words DFSS is not considered to be a problem solving methodology, but rather a way of preventively assuring Six Sigma quality in development. Furthermore, the fact that a new PDP needs to be created anyway implicates the exquisite opportunity to “kill two birds with one stone” – why then not integrating DFSS in that new development process?

7.4 Requirements on the new Product Development Process

The first step towards a single PDP applicable to development projects of all business divisions was to investigate and record how the seven development centres develop their products today. Stemming from the established procedures and practices at the respective sites different requirements may arise on the new development process. These requirements naturally come from the different kinds of products and services offered by the three business divisions of XYZ. In the automotive division, many development projects are done with one big customer in mind. For example, a new production facility might be set up to serve one customer as a result of a single development project. In the Industrial Division, the business is more fragmented since OEMs are served from this division. One development project might aim at several different market segments and a large number of customers who build the XYZ products into the equipment. Besides ascertaining current product development practice at the respective sites, it was important to gather their different requirements on the prospective development process. While being up-to-date and reflecting DFSS standards, the new process is supposed to be based on what is already in place at XYZ as much as possible in order to exploit synergies coming from existing practice and knowledge, and minimize resistance typically occurring when change is required.

The Kano model (Kano, 1984) can be used to illustrate the way of thinking in the DFSS implementation team concerning the requirements on the new PDP. It displays the expected fruits of accomplishments for meeting the different kinds of requirements. In terms of the Kano model, accounting for what is already in place is associated with satisfying the unspoken needs that are reflected in must-be quality features, see figure 7.2.

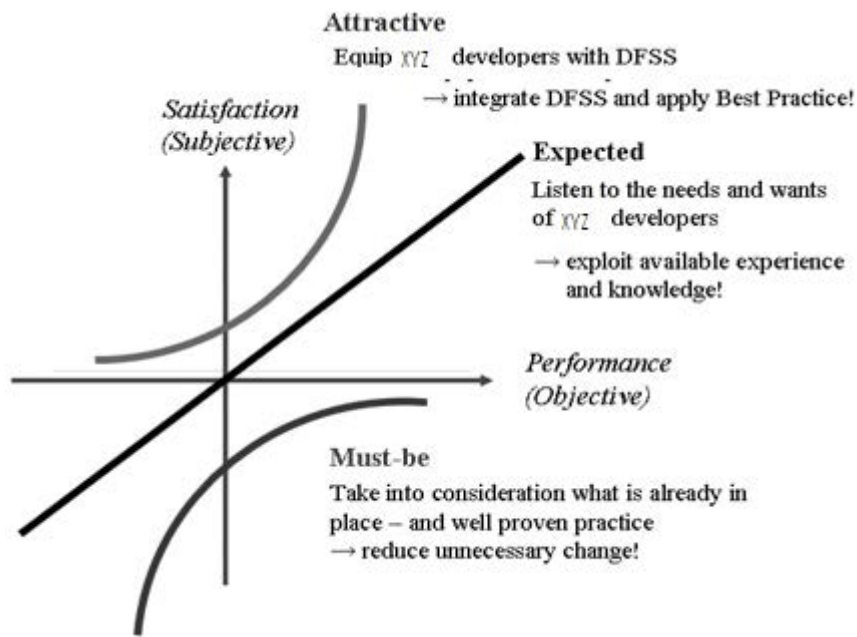

Figure 7.2: Kano model relating requirements on the PDP to expected fruits of their accomplishments

During visits to the different development centres the status quo practice has been recorded, as well as the individual requirements on a prospective development process. The following table 7.1 summarizes and at the same time compares the different practices concerning six selected development centres (DCs) of XYZ.

Characteristic	DC 1	DC 2	DC 3	DC 4	DC 5	DC 6
Project types	Platform, segment, tailored	Platform, segment, tailored	Platform, segment, tailored	Platform, segment, tailored	Platform, segment, tailored	Tailored
Resources at project start	No stipulation	No stipulation, priorities can change quickly	No stipulation	Stipulation with follow-up	n.a.	Stipulation
Process structure (Phases)	Assigned reactively: Idea, Pre-study, Preparation, Realization, Close-out	Pre-Study, Preparation, Development, Launch, Close-out	Dependent on project leader, no regular phase structure	Idea, Specification, Realisation, Implementation, Follow-up	Feasibility, Principal sketches, Customer proposal, Finalize/Optimize design, Launch samples, Process development, Validation	Idea, Benchmarking, Development with customer, Industrialization
Control mechanism	Quarterly reviews for appropriate prioritizations	Reviews as needed and always before release of design rules	3 defined reviews: preliminary, intermediate final review	Project reviews monthly, design reviews as needed	Project reviews held every 2-4 weeks	Irregular reviews
Multi-disciplinarity	High	High	High	High	High	Project dependent

Table 7.1: Different product development practice at different DCs

As a result the process has to be sufficiently flexible to be suited for tailored, as well as platform and segment driven development projects. This requires a process on a generic level focusing rather on strategic core deliverables than details of organizing or administering the work process. The fact that in most development centres resources are not stipulated from the very beginning of development projects does not necessarily mean that this practice should be maintained. As it turned out there is an outspoken desire at all sites for stipulating resource commitment at the beginning of development projects. In most centres there is, furthermore, a certain phase structure supported by project reviews that are held on a regular basis though with different frequencies. The degree of interaction between different functions in product development projects is high at each site – a fact worthwhile to maintain which should not be endangered by the new PDP.

In addition to current practice the individual requirements of the development centres on the development process were recorded. Those requirements are based on experience and lessons learned from past development projects. Referring again to the Kano model, taking such requirements into account can be compared with satisfying the outspoken needs associated with expected attributes. The requirements that came up during the visits are:

- Clear phases containing defined contents and well-defined interfaces with clear inputs and must-be inputs for starting up or continuing a project, respectively
- Gates with clear deliverables and responsibilities concerning decisions to be taken
- Simple, visible, transparent and easy-to-use
- Checklists driving the transition between phases
- Clear allocation of responsibilities in all parts of the process
- Tool usage guidance/support
- Technical gates to deal with technical issues, especially for bigger projects
- Foster front-end loading of product development projects including early preparation of requirements specification
- Alignment with other concerned processes
- Applicable for all project sizes
- Containing the core of the DFSS methodology

The requirement to correspond to the core aspects of the DFSS methodology deserves some more clarification: what does it literally mean? Recalling XYZ's definition of DFSS it should mean that the new PDP shall foster the development of products to Six Sigma standards. This is achieved by focusing on the most essential aspects captured by the DFSS methodology, such as customer focus and robustness, and doing so systematically from the very beginning of development projects. In order to stimulate innovation and creativity, the development process should not prescribe the use of certain tools or methods but what will be required instead are deliverables that comply with the main ideas and prioritizations underlying DFSS and that can further assure successful accomplishment of development projects. In terms of the Kano model, successful integration of the core aspects of the DFSS methodology with the PDP can be compared with satisfying attractive attributes improving future XYZ products so that they will not only meet, but preferably exceed customer expectations, see figure 7.2.

7.5 Developing for Six Sigma at XYZ – the Process on a Map

An important, if not the most important aspect to start with can be to clarify the sources of inspiration and information that the process will be based on. Firstly, as a matter of course, the experience and knowledge that has been gained over the years within the XYZ group plays a vital role and will inevitably be reflected in the final result. Secondly, conventional product development literature has been consulted, such as Pahl and Beitz (2005), Ullman (1997) and Wheelwright and Clark (1989). Thirdly, DFSS text books have been studied, such as Chowdhury (2002), Tennant (2002), Yang and El-Haik (2003) and Creveling et al. (2003) where the latter served as a reference source of inspiration. Fourthly, benchmarking of leading corporations, such as Ericsson and Volvo was taken into account. Lastly, an executive seminar with Robert Cooper directed attention to the principles of Lean New Product Development (NPD). Lean NPD involves striving for both customer focused – unique, superior and differentiated products, and front-end loading the development projects resulting in increased profits. So, Lean does not merely focus on cost and time reduction by removing waste and time-to-market.

All these sources led to XYZ's new PDP consisting of four major phases: Technical feasibility, Design & Verification, Validation and Hand-over. The first two are sub-divided into three stages, respectively: Scoping, Requirements specification, Concept generation & selection on the one hand and Embodiment design, Detail design, Verification on the other hand, as illustrated in figure 7.3. Figure 7.3 furthermore shows approximately how XYZ's IDDOV procedure with its contents is contained in the PDP.

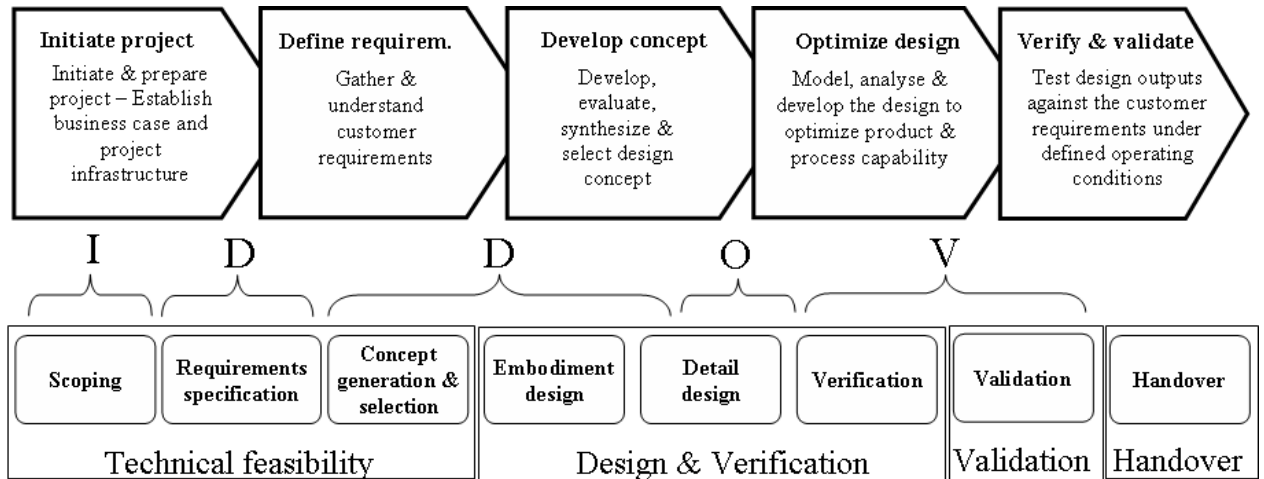

Figure 7.3: Phases of XYZ's PDP and their relation to the IDDOV phases of the DFSS methodology

In the following all eight stages are illustrated by defining their outputs with respect to DFSS. To simplify matters, even though well-defined the inputs are excluded here; by and large they are the outputs of the respective previous stage with some exceptions that do not matter in this context. Taking the core of the DFSS methodology into account the outputs inherently accomplish the implementation of DFSS. In other words, if (DFSS) outputs of the e.g. Requirements specification stage, such as ‘ranked customer needs’ further expressed in ‘measurable functional requirements’ are actually accomplished during this stage, DFSS can be considered to be implemented to that extent. Doubtlessly, the true challenge will be the avenue to such accomplishments. For this reason, in each stage non-binding recommendations are given concerning tools that may be of help to meet the deliverables. They are non-binding in order not to limit the engineers’ creativity and imagination to any degree: tools are merely means of achieving the desired outputs. They should not be strictly prescribed merely for the applications sake per se and often there are several tools available that can be utilized to achieve the required output. However, in each stage there are some activities that must be performed to meet the desired outputs. These activities are captured in checklists helping the development team to fragment the tasks to be accomplished within a stage. From a DFSS perspective, the checklists ensure that nothing important can be overlooked or neglected. The following table 7.2 addresses the DFSS related contents of the eight different stages.

Phase/Stage	Output	Tools	Checklist
Technical Feasibility	Scoping Agreement on main goal & limitations, Go decision Main goal and limitations for the development project/task including identified internal customer		Assure involvement of all necessary parts of the organization Check that inquiry is complete
	Requirement specification Functional description & measurable requirements of customer needs Ranked customer needs expressed in measurable functional requirements, CTQs, Non-functional requirements (e.g. environmental, regulatory, safety, cost, etc.), Verification & Validation criteria	Benchmarking, QFD (House of Quality 1), Kano model, Scorecard, VOC gathering methods	Gather VOC (external and internal), Rank customer needs and translate into measurable functional requirements with target values
	Concept generation & selection Generate, evaluate & select concepts Description of most promising concept(s), Verification & Validation plan	Pugh Matrix/ Hybridization, Benchmarking, Innovation & creativity tools (e.g. TRIZ, Six hats)	Define concept selection criteria (e.g. robustness, reliability, cost), Generate concepts in cross-functional teams, Evaluate & rank concepts according to defined selection criteria including robustness
Design & Verification	Embodiment Design Embody concepts and evaluate using prototypes Product documentation (e.g. drawing, functional description, failure mode assessment), Prototypes (incl. virtual prototypes), Supplier identification (internal and/or external), Reliability & Robustness plan, Updated Verification & Validation plan	Simulation, Prototyping, DoE, D-FMEA, VMEA, Transfer functions, Functional process mapping, FAST (Functional Analysis System Technique), P-Diagram, QFD (Houses of Quality 2-4), Design for X	Get functional understanding of concept(s), Identify failure modes and effects, Translate functional requirements into design parameters, Map noise factors (e.g. external, internal and unit-to-unit), Make preliminary design verification: Calculations (transfer functions), Modelling & Simulation, Physical tests, Develop plan for Robustness & Reliability, Update & refine verification & validation plan (noise factor influence, design parameters)
	Detail Design Detail and optimize the design Product documentation (as before), Proposed design rules, Measuring principles	Transfer functions, Loss Function for Tolerance Design, D-FMEA, DoE, Taguchi methods, Parameter Design, Sensitivity analysis, ANOVA, Design for X	Perform preliminary design verification: Calculations (transfer functions), Modelling & simulation, Physical tests, Account for Robustness & Reliability, Update noise factor mapping, Perform Product characterization (mathematical model to optimise), Optimise design (Mean and variation), Perform Tolerance design
	Verification Check that design fulfils requirements Product documentation (as before), Released design rules, Released product (ready for validation)	Testing, Modelling & Simulation, HALT/ HAST testing	Perform verification test, Perform Robustness & Reliability assessment
Validat.	Validation Check customer acceptance Product documentation (see above), Design proven in its intended environment	Field tests, Testing, Modelling & Simulation, HALT/ HAST testing	Perform validation tests, Perform Robustness & Reliability assessment
Hand.	Hand-over Hand over to e.g. production Product development documentation, Launch support		Document the lessons learned from the project including Robustness & Reliability lessons

Table 7.2: DFSS aspects of the new PDP

7.6 DFSS Infrastructure at XYZ

The infrastructure for DFSS includes a DFSS core team acting on an XYZ Group level and being responsible for education and support with respect to the DFSS methodology. This core team furthermore coordinates DFSS related activities and integrates, if applicable, interested parties from the outside of the development organisation. Each business division has one assigned innovation process manager being the process responsible for the new PDP in the respective division. The introduction of the new PDP has been finalised in the industrial division while the automotive division is still in the implementation phase. The service division has not initialised the implementation yet and it should be noted that it has less distinct focus on product development related activities as the other two divisions. Each DC within the industrial division has its own local PDP champion being responsible for local DFSS education and answering potentially arising questions locally; again, today this is only valid for the industrial division but the future holds the same kind of infrastructure for both the automotive and the service division. The following figure 7.4 illustrates the organisational infrastructure for DFSS within XYZ and focuses on the industrial division where the implementation has made most advancement.

In addition to this manned infrastructure there is an intranet support available to all 40.000 XYZ employees. The intranet support comprises a detailed PDP description including education material and checklist support for the respective phases of the process. It also includes support for the application of all tools associated with the DFSS methodology. However, no infrastructure can compensate for knowledge and experience that are necessary for e.g. applying DFSS tools successfully.

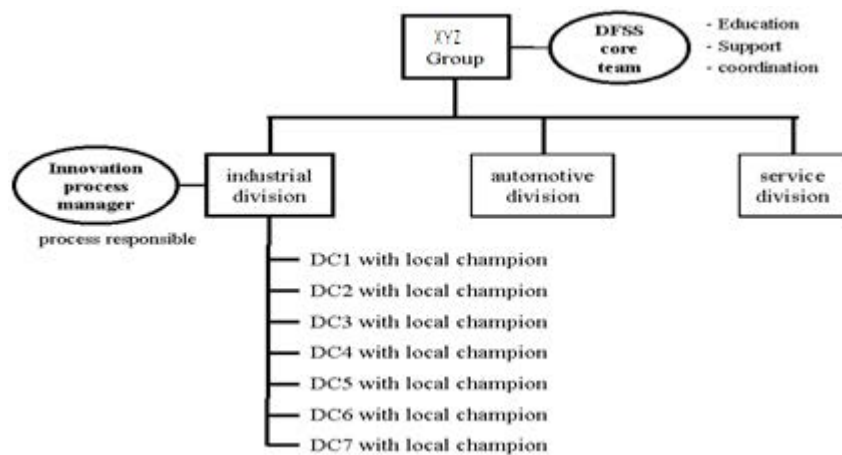

Figure 7.4: Organisational DFSS Infrastructure within XYZ

At XYZ the DFSS education is divided into three different levels that build upon each other. Level one education is mandatory for the entire product development organisation and consists of a 3-day training session where the employees are trained in the basics of the following topics: DFSS, the new PDP, VoC, innovation and creativity, statistical design and robustness. Level two education applies to approximately 20% of the product development organisation and is intended for sub-project leaders, design engineers and technicians. Within a total of 9 days – structured into three 3-day blocks with continuous coaching in between the blocks – the participants delve into and elaborate on the contents of the level one education. In addition, they are trained in simplified innovation tools and Taguchi Methods and they are required to prove their skills on the basis of a real development project that must be brought along by each participant. At least one employee per DC must receive level three education in order to take the role of a local DFSS champion as described above. The contents of this education differ from case to case as it constitutes a specialisation in a certain subject matter appertaining to the DFSS domain.

In the next phases of implementing DFSS at XYZ the remaining two business divisions will be involved. Once this is completed the company wide implementation will proceed with going across the product development organisation in order to address also technology development work at XYZ. However, first DFSS results have been accomplished by the product development organisation of XYZ's industrial division. The following table 7.3 summarizes three completed DFSS projects including the benefits that have been achieved.

Customer & business	Project goal & duration	Key DFSS tools used	Benefits to customer	Benefits to XYZ
Off-highway mining equipment	Planetary bearing solution, 18 months	Statistical modelling & simulation, Virtual DoE, transfer function, Monte Carlo analysis, virtual validation.	Extensive lifetime increase, Service life increase, reduce warranty costs, improved satisfaction, potential to optimised gear design	Project revenues (\$250K), win business from existing application and grow new business (\$10M in new business won with a potential for another \$5-10M from replication), “going beyond bearings” (offering system solutions)
Automotive industry (carmaker)	Smart electro-mechanical steer-by-wire solution, 10 months	VoC, QFD, DoE, P-diagram, transfer function, Pugh Matrix, Monte Carlo	Increased passenger compartment space by removing the steering column, customised steering wheel angle and drive feeling	Demonstrated feasibility of a 12V steer-by-wire system for small passenger cars, possibility to customise steering wheel angle and drive feeling
Automotive industry (carmaker)	Parking brake-by-wire linear actuator solution, 8 months	VoC, QFD, Benchmarking, Pugh Matrix, DoE transfer function, Monte Carlo	Higher reliability and performance (e.g. 3000N max. force vs. 2300N before), increased robustness (e.g. low temperatures)	Demonstrated feasibility of a 12V parking brake-by-wire linear actuator solution for passenger cars

Table 7.3: Examples of DFSS projects completed at XYZ

7.7 Discussion

Design for Six Sigma is not as consistently defined and understood in literature as e.g. the Six Sigma methodology suggesting a review and discussion of the reasons and motivation for an implementation at XYZ. Further, the way of implementing it by integrating it into the PDP should be discussed as literature does not serve with much support in this respect. When should DFSS be implemented and driven via particular projects and when should it be integrated into the PDP? Maybe even more interesting can be a discussion on the implications of integrating DFSS into the PDP compared to the option to drive it via DFSS projects.

As Gremyr (2005) notes, it is not unusual that companies' interest in DFSS emanates from their already successfully implemented Six Sigma initiatives, as it might be assumed for XYZ working with Six Sigma projects for several years. However, the fact that XYZ – agreeing with Chowdhury (2002, p. xv) – considers the two methodologies to be “*fundamentally different quality initiatives*” suggests also other reasons for a DFSS commitment. In accordance to the prevailing upstream trend of quality improvement, with DFSS the Six Sigma level of ambition shifts upstream in the product lifecycles and aims at preventing failures from occurring during developmental stages which, in fact, is one operational goal at XYZ. It is during those early stages where most opportunities to failure mode avoidance are available. Thus engineering effectiveness can be increased by focusing on development and front-end loading the PDP with appropriate activities.

Many tools of the DFSS methodology, such as Quality Function Deployment (QFD) or the Kano model, are contributing to front-end load the PDP with the purpose of achieving design stability as early as possible. According to Magnusson et al. (2004), it is well-known that reaching design stability earlier in the development process reduces change cost considerably since late changes will be very expensive when compared to changes early on in the development project when the design is still susceptible to changes in e.g. concept terms. Further, a stronger dedication and focus on the final customer comes along with a successful DFSS implementation. Against the background of both the goal to increase customer satisfaction in general and the strategic commitment for complete system solutions, a more sophisticated exploration of the customers and their business and consequential needs appears advisable; when the 'products' sold comprise the fulfilment of certain functions it is of utmost importance to fully understand what function is required and how this solution is integrated in the customer's business.

Another goal with the DFSS implementation is stated to be a reinforcement of the PDP which inevitably leads us to the fundamental question of how to implement DFSS. On the one hand DFSS can be integrated into the PDP and on the other hand it can be driven via DFSS improvement projects quite in the style of Six Sigma DMAIC projects but applied to development tasks. While particular DFSS improvement projects usually are initiated for e.g. *"historically problematic areas or new and strategically important areas"* (Gremyr, 2005, p. 301), an integration will result in applying DFSS to all development projects. Thomas and Singh (2006) see an integration of DFSS into the PDP as the most suitable alternative when the focus of development projects lies on the prevention of potential and the elimination of already known failure modes. They further relate various development project objectives to different project structures concluding that an integration of DFSS into the PDP is most suitable for the following types of project objectives: complete new product development, elimination of both known and potential failure modes and concept development. Hence, given XYZ's definition of DFSS and the goals set with its implementation it may appear most appealing to integrate DFSS into the PDP. However, integration involves many intricate challenges that could be conveniently avoided by driving DFSS via projects. One such challenge is the fact that all processes that are related to the PDP will have to be aligned with the new PDP – in fact one of the outspoken requirements on the process. In addition, unlike the (relatively few) project members working in DFSS improvement projects, all engineers working with the PDP must be trained in DFSS. Endorsing these difficulties Chowdhury (2002, p. 47) notes that *"Integrating DFSS into an enterprise's [New] Product Development Process (NPDP) is quite a different challenge. It's the difference between working with a caged lion and a free-roaming one."* However, acknowledging the fruits of a successful integration he (2002, p. 163) holds that *"... the real power of Design for Six Sigma is realized as you mature the integration of DFSS into your [new] product [and service] introduction process [...]. Companies that effectively accomplish this level of maturation in DFSS will command almost insurmountable competitive advantages."* Supporting this Treichler et al. (2002, p. 34) see that *"Several notable exceptions use DFSS on every project. These firms report the most substantial from their organizationwide adoption of DFSS. It would appear from these data there is a critical level of utilization and application at which time the additive effects become multiplicative."*

To this day we have not seen any empirical evidence for such a 'critical level of utilization and application where the additive effects become multiplicative'. Design for Six Sigma case studies available in literature are based on particular DFSS improvement projects; there is no 'complete story' available showing a whole development project with all DFSS activities performed in it. This is not surprising given the fact that, e.g. at XYZ, development projects usually take several years. It is hoped that providing an insight into ongoing work at XYZ can help others with their DFSS efforts by an increased understanding of the concept per se and a presentation of and motivation for one possible way to implement the concept in a company. It should be noted that an implementation basically represents the beginning of any DFSS engagement; a methodology, such as DFSS, cannot be simply 'implanted' in a company and thereafter expected to be applied. Instead what must follow is a kind of cultivation of the methodology meaning that e.g. employees need to be taught and committed drivers and trainers chosen as it is described in the previous chapter outlining the infrastructure for DFSS within XYZ.

7.8 Conclusions

Design for Six Sigma strives for quality improvement during design stages by primarily focusing on customers and robustness. Unlike Six Sigma, there is no established way of implementing DFSS in a company. One possible way is to implement it via well-structured improvement projects. For DFSS there have arisen a number of stepwise procedures, as opposed to Six Sigma with its well-established DMAIC procedure. Another possible way is to integrate DFSS into the PDP. This latter strategy is presented in this study including the motivations for both the choice for DFSS in general, as well as the decision to integrate it into the PDP. There are no doubts that an integration of DFSS into a company's PDP constitutes a notably stronger commitment with much more challenges when compared to organizing DFSS in particular improvement projects. However, there are high expectations that coping with process integration may be profitable in the long run. Furthermore, certain circumstances can facilitate the decision for integration. To this day no empirical evidence is available confirming the high expectations in terms of profitability. It will be interesting to see the first DFSS case studies that comprehensively describe the outcome of complete development projects where the methodology has been integrated into the PDP.

7.9 References

- Berryman, ML 2002, 'DFSS and big payoffs', *Six Sigma Forum Magazine*, vol. 2, no. 1, pp. 23-28
- Chowdhury, S. 2002, *Design for Six Sigma – The Revolutionary Process for Achieving Extraordinary Profits*, Dearborn Trade Publishing, Chicago
- Creveling, CM., Slutsky, JL., & Antis, D 2003, *Design for Six Sigma - In Technology and Product Development*, Prentice Hall, New Jersey
- Cole, R 1999, *Managing Quality Fads – How American Business Learned to Play the Quality Game*, Oxford University Press, New York
- El-Haik, BS., & Suh, NP 2005, *Axiomatic Quality: Integrating Axiomatic Design with Six-SIGMA*, Reliability and Quality Engineering, Wiley, New Jersey
- Gremyr, I 2005, 'Exploring Design for Six Sigma from the viewpoint of Robust Design Methodology', *International Journal of Six Sigma and Competitive Advantage*, vol. 1, no. 3, pp. 295-306
- Kano, N. 1984, 'Attractive quality and must-be quality', *The Journal of the Japanese Society for Quality Control*, April, pp. 39-48
- Magnusson, K., Kroslid, D., & Bergman, B 2004, *Six Sigma umsetzen*, Hanser, Munich
- Pahl, G. & Beitz, W 2005, *Engineering Design*, Bell & Bain Limited, Glasgow
- Soderborg, NR 2004, 'Design for Six Sigma at Ford', *Six Sigma Forum Magazine*, November, 2004, pp. 15-22

- Tennant, G 2002, *Design for Six Sigma: Launching New Products and Services Without Failure*, Gower Publishing Limited, Hampshire
- Thornton, A 2004, *Variation Risk Management, Focusing Quality Improvements in Product Development and Production*, Wiley, New Jersey
- Thomas, M., & Singh, N 2006, 'Complexity reduction in product design and development using Design for Six Sigma', *International Journal of Product Development*, vol. 3, no. 3/4, pp. 319-336
- Treichler, D., Carmichael, R., Kusmanoff, A., Lewis, J., & Berthiez, G 2002, 'Design for Six Sigma: 15 lessons learned', *Quality Progress*, vol. 35, no. 1, pp. 33-42
- Ullman, DG 1997, *The Mechanical Design Process*, McGraw-Hill, Singapore
- Wheelwright, SC & Clark, KB 1989, *Revolutionizing Product Development – Quantum Leaps in Speed, Efficiency, and Quality*, The Free Press, New York
- Yang, K., & El-Haik, B 2003, *Design for Six Sigma – A Roadmap for Product Development*, McGraw-Hill, New York

8 Six Sigma in Administration – past its use by date?

Ollie Jones and Andrew Monks

Strategy & Business Analysis Subject Group

Faculty of Business and Law, Leeds Metropolitan University, UK

Abstract

The purpose of this research was to review the existing literature to construct a framework of critical success factors involved in non-technological areas of six-sigma implementation, followed by an investigation of Six Sigma practice in a Human Resources function to rank these factors and investigate implementation behaviour in this context. Following the literature review of critical success factors the empirical research element combines the use of qualitative and quantitative methods and data collection from employees involved in Six Sigma projects within a Human resources function. The findings revealed that Six Sigma was used effectively in any non-technological areas of business, such as HR in a European context, although practitioners believe that the project must have some measurable aspect to it, in order for it to be suitable. The hegemony of Six Sigma was being challenged by the use of other methodologies and tools, in particular Lean. The users of these concepts use their ability to choose and perhaps more significantly to merge between the methodologies, tools and techniques of Lean and Six-Sigma, based on some key factors. The critical factors involved in Implementation of Six Sigma Programmes can be ranked, but the results although new to Six Sigma literature are not startling when compared to the previous quality methodologies, such as TQM. The research indicates that critical success factors are important but do not tell us anything we did all not already know from decades of process and quality improvement. However the case study research questioned whether this theoretical framework may not be suitable as it revealed that the hegemony of one particular methodology over another is starting to break down and that choice and cross-pollination is starting to occur. Practitioners have developed their own conceptual framework to aid that decision-making. Hence the most interesting area to research further is to investigate this practice in other cases and contexts, and attempt to develop and map the this “choice conceptual framework” further.

Keywords: Six Sigma, Human Resources, Lean, Critical success factors, case study

8.1 Introduction

According to the key findings of the Does et al (2002) study “*Non-manufacturing is the new frontier in quality improvement. Such processes have great potential for economic saving and are ripe for quality improvement. A high volume of transactions often characterizes non-manufacturing processes. Moreover the processes are typically labour intensive and costly and the transactions are often not well defined. In fact non-manufacturing processes are usually not planned or designed and have frequently never been subjected to rigorous study*” (Does et al. 2002). This shows that employing Six Sigma methodologies in non-technical areas of business is still a fairly new trend and has massive scope to improve business productivity and profitability even further.

Antony (2005) believes that *“some of the emerging research trends of Six Sigma include: integration of Six Sigma with Lean Thinking and agile manufacturing, development in new application areas such as healthcare, finance, sales, human resources, software engineering; integration of Six Sigma with other quality initiatives such as ISO 9001:2000, and EFQM Excellence”*. Torre (2006) believes that the Six Sigma methodology could be applied successfully to any aspect of an organisation. *“Whether it is the accounting department, customer service, sales, human resources or manufacturing, all components of an organisation stand to benefit from implementation of this methodology”* (Thurston, 2006, p42) and the future of Six Sigma points towards organisations in fact trying to implement Six Sigma in all functions of their business.

The Dusharme (2001) study shows that in a study of nearly 4500 Six Sigma users, nearly as many are using Six Sigma methodologies for administration and customer service as are using it for manufacturing and engineering. This supports the claim that *“Six Sigma is now increasingly applied to a wide-variety of non-manufacturing operations also”* (Does et al. 2002). Does et al (2002) also claim that *“this is an important development – there are potentially more benefits to be achieved in those areas that in traditional manufacturing where decades of good work have already paid off”* (Does et al. 2002).

However Hendry & Nonthaleerak (2005) criticise that the majority of Six Sigma research done to date is of a descriptive nature, and there is limited empirical research available. (See Fig. 6). Brady and Allen (2005) also state that *“Only a small fraction of articles in our database pertain to an empirical model or evaluation”* (Brady & Allen 2005, p23). Hendry and Nonthaleerak also believe that globalisation presents a reason for further research being needed because of cultural differences, *“the research territory to date has been commonly found to focus on Six Sigma implementation in the North America region with only a few studies in Europe”* (Hendry & Nonthaleerak 2005, p31).

This paper aims to address these issues and therefore consists of two elements- A review of the existing literature to construct a framework of critical success factors with which to research the potential ranking of importance of these for organisations involved in non-technological areas of six-sigma implementation. Investigation of Six Sigma implementation and practice in a non-technological area of business, in this case a Human Resources function in a European context.

8.2 Literature Review

Coronado & Antony (2002) suggests that there are best practices, or *“critical success factors”* (CSF) that are vital for Six Sigma to succeed. The idea of identifying CSFs as a basis for determining the information needs of managers was popularised by Rockart (1979). CSFs are those factors which are critical to the success of any organisation, in the sense that, if objectives associated with the factors are not achieved, the organisation will fail – perhaps catastrophically so (Rockart 1979).

Coronado & Antony (2002) have conducted a review of the literature related to the critical success factors for the effective implementation of Six Sigma. They identified 12 CSFs from their review of Six Sigma text books and other related Literature (Hendry & Nonthaleerak 2005, p26). These CSF are related to all functions of business and form a general guideline of what needs to be achieved for Six Sigma implementation to be successful. The work put forward by Coronado and Antony (2002) is credible, as it summarises the findings of all research in CSFs to date. The CSFs identified were:

- **Management involvement and commitment:** Those who have implemented and practised Six Sigma agree that the most important factor is continued top management support and enthusiasm (Henderson & Evans 2000). Eckes (2000) identified that “managers must be involved in the creation and management of the process management system, and also be involved in projects themselves (Eckes 2000) and Pande et al (2000) states that “without the top management commitment and support, the true importance of the initiative will be in doubt, and the energy behind it will be weakened” (Pande et al. 2000)
- **Cultural Change:** Implementing a Six Sigma initiative involves substantial change in the structure and infrastructure of an organisation. If the implementation is to be successful, the employees of the organisation must not be resistant to change, and be able to adapt well to new initiatives
- **Communication:** A communication plan is important in order to involve the personnel within the Six Sigma initiative by showing them how it works, how it is related to their jobs and the benefits from it (Henderson & Evans 2000)
- **Organisation Infrastructure:** In order to implement Six Sigma within any organisation, some key organisational characteristics need to be already in place. (Conorado & Antony 2002). These characteristics are listed as great communication skills, a long term focus and a team work ethic. It is also vital to have enough resources and investment to embark on Six Sigma.
- **Training:** Training is a crucial factor in the successful implementation of Six Sigma projects. It is critical to communicate both the “why” and the “how” of Six Sigma as early as possible, and provide the opportunity to people to improve their comfort level through training classes (Hendricks and Kelbaugh 1998)
- **Linking Six Sigma to business strategy:** Six Sigma cannot be treated as yet another stand-alone activity. It requires adherence to a whole philosophy rather than just the usage of a few tools and techniques of quality improvement (Dale 2002). Six Sigma must tie in with the organisations overall strategy.
- **Linking Six Sigma to customer:** Six Sigma should begin and end with the customer. Projects should begin with the determination of customer requirements. An important issue here is the identification of the critical-to-quality characteristics (CTQ) (Coronado & Antony, 2002)
- **Linking Six Sigma to human resources:** Truly changing behaviour over the long term requires Six Sigma goals to be internalised on the individual level. To this end, human resources-based actions need to be put into effect to promote desired behaviour and results (Harry & Schroeder 2000)

- **Linking Six Sigma to suppliers:** Under Six Sigma, one way to reduce variability, and thus room for error, is to have few suppliers with Six Sigma performance levels (Pande et al. 2000)
- **Understanding tools and techniques within Six Sigma:** Since methodologies vary from organisation to organisation, there is no standard methodology, and organisations must be capable of choosing the most appropriate tools and techniques applicable to them (Pande et al. 2000)
- **Project management skills:** Another key ingredient in the implementation of Six Sigma is that project leaders must have some basic project management skills (Coronado & Antony, 2002). Most of the Six Sigma projects that fail, do so due to poor management skills, setting agendas, setting and keeping ground rules, determining the meeting's roles and responsibilities, or undesired facilitative behaviours (Eckes 2000)
- **Project prioritisation and selection:** As Six Sigma is a project driven methodology, it is essential to prioritise projects which provide maximum financial benefits to the organisation. The projects are selected in such a way that they are closely tied to the business goals or business objectives of the organisation (Ingle & Roe, 2001)

Coronado & Antony (2002) conclude that if any of these ingredients are missing from a Six Sigma, it could be the difference between a successful project and one that fails. The research conducted within this paper will try to establish if there is an order of importance within these and other factors.

8.2.1 Non-manufacturing Applications

Hendry & Nonthaleerak (2005) state that one of the existing few notable empirical studies, and perhaps most important in investigating the application of Six Sigma in human resources, is by Does et al (2002). Does et al (2002) conducted a comparison between eight different Six Sigma projects in non-manufacturing areas of the business using the traditional (manufacturing) application. This research was conducted in the Netherlands. Does et al (2002) found that Six Sigma can be applicable with a minor adaptation.

Perhaps most importantly, Does et al (2002) go on to say “On the basis of the analysis of our sample of eight projects and our general experience of applying Six Sigma, we conclude that differences between manufacturing and non-manufacturing do exist. The primary difference is mental; using qualitative methods in non-manufacturing is not common and will frequently require an attitude change. However, in general we consider the differences to be relatively minor. Clearly, as well discussed above, the emphasis may occasionally be different. However, it is our conclusion that Six Sigma’s general approach to problem solving and the associated tools are applicable with only minor adjustments and can be used with benefit in both manufacturing and non-manufacturing” (Does et al, 2002).

The study by Foulkes & Keight (2002) examined the application of Six Sigma into Human Resources and internal recruitment at Ford Motor Company. The key outcomes of applying Six Sigma were reduced processing time, reduced rejection rate (27% to less than 1%), reduced process workload, reduced administration costs of US\$120,000 and increased productivity US\$96,000. Again this demonstrates the potential for mass savings and increased productivity within Human Resources. Ford also learnt a number of key lessons and presented them as advice for companies wanting to apply Six Sigma into HR. These lessons were: (Foulkes & Keight 2002, p29)

- “The benefits of six sigma are innumerable – don’t fear the training process that can take time”
- “Take a process view to project management”
- “Take the time to identify your process before committing to any Six Sigma project
- “Get leadership and business partner sponsorship early on in the game”
- “Use black belts as mentoring resources for other projects”
- “Remember that some of the critical inputs necessary to improvement may be outside the realm of your control”
- “Trust your data – so called “experts” are not infallible”
- “While Six Sigma can crack some tough nuts, the methodology can be resource intensive”
- “Involve your staff and make sure they understand the mission and scope of the project”

The findings at Ford Motor Company back up the study conducted by Does et al in the sense that they agree that Six Sigma can be applied into Human Resources and they also state that some minor alterations need to be made in order to achieve optimum results. Due to Foulkes & Keight being employees of Ford Motor Company in Europe, there is a danger that the research carried out may have been subject to researcher bias. The two researchers may have wanted the implantation of Six Sigma within their HR department to be successful and thus it may have caused their findings to be over positive.

Wyper & Harrison (2000) presented research into the use of Six Sigma in HR functions and also found that it can be applicable with minor adaptations. The research involved a case study approach in which the deployment of Six Sigma within Human Resources was investigated. The case study found that “The cost of HR function per employee has been reduced by 34% in 18 months, with the same or better service provided, and an overhead cost reduction of £250,000 has been achieved” (Wyper & Harrison 2000). The study also found that HR employees started enjoying greater customer satisfaction and loyalty (Wyper & Harrison 2000). The study also highlighted some key differences between deployment of Six Sigma in manufacturing and deployment in human resources: (Wyper & Harrison 2000).

- “Lower initial credibility of Six Sigma in HR”
- “More difficult definition of process scope and higher impact of perceptual elements”
- “Direct dealing with people can be more frustrating, but more rewarding as well”
- “High intangible cost of poor quality (e.g. recruitment of false positive)”
- “Less tangible measurements require more creative approach”
- “Higher variety in customer requirements”

The study finds again that the success of Six Sigma is very much dependent on good leadership. One criticism of the study by Wyper & Harrison is that it is an internal study carried out by employees of the company in question; therefore the researchers may be unwilling to reveal any negative information.

8.2.2 Summary and Framework

By combining these previous studies the authors have constructed a combined table of critical success factors (CSF's). Many of the studies describe, in some detail, the many critical success factors that currently exist for a Six Sigma project to be effective, however to date no researcher has gone about putting these factors into order of which is the most important and which is the least. Therefore, this paper aims to clarify which are the most important critical success factors when applying Six Sigma in a non-manufacturing context.

Number	Key Point	General	Non-Manufacturing	Both
1	Good leadership is essential	✓	✓	✓
2	Management involvement/commitment	✓	✓	✓
3	Culture of organisation is important	✓		
4	Good communication essential	✓		
5	Organisational infrastructure important	✓		
6	High level of training required	✓	✓	✓
7	Link Six Sigma to business strategy	✓		
8	Link Six Sigma to customer	✓		
9	Link Six Sigma to HR	✓		
10	Link Six Sigma to suppliers	✓		
11	Understand the Tools & Techniques	✓		
12	Project prioritisation and selection	✓		
13	Take a process view to management		✓	
14	Use Black Belts as mentors	✓	✓	✓
15	Involve all staff	✓	✓	✓
16	Trust your data – so called “experts” are not infallible		✓	
17	Slight variation of tools / methods required	✓	✓	✓

Figure 8.1: Findings from Critical Success Factors study

8.3 Methodology & Case Study

One criticism of the key studies to date is that the research carried out was by conducted by employees of the company that was investigated; with subsequent issues of impartiality and a lack of positivistic rigour as the researchers are having an effect on the study and also being effected by it.

This research combines the use of qualitative and quantitative methods and data collection from different sources to enable some degree of validity. The qualitative data was derived from semi-structured interviews from six people who have been involved in various projects in a HR environment. The quantitative data was attained by the use of a simple questionnaire of a sample of 30 from 90 based on the critical success factor framework.

The organisation that will be investigated and used in the research for this paper is a large multinational company, with a history of over 100 years. It has been viewed as one of the first true Six Sigma organisations, and achieved billions of pounds worth of savings due to its implementation across the board. The organisation is involved in a number of products and services, from producing aircraft engines, to providing financial solution for business and consumers worldwide. It has been using Six-Sigma in various HR projects for some time and the interviews and survey subjects have varying degrees of experience in application and use of Six Sigma.

8.4 Results

All interviewees believed that Six Sigma is an appropriate methodology for HR/Admin and majority of all other business functions, and had seen real business benefits in a range of projects, such as creating a specialised HR service centre. However one of the consistent findings was that the practitioners believed that the project had to have some data within that could be measured, in order for six-sigma to be appropriate, which may not necessarily cover all aspects of a particular function, such as HR. This is in agreement with Does et al (2002) and Wyper & Harrison (2000)

“So I would say you can use it in pretty much any function providing you can measure and improve something”

“If you can measure something, you can apply Six Sigma!”

“You can use the tools in almost anything – anything you can measure you can use the tools”

“I suppose you wouldn’t use Six Sigma if there was nothing to measure”

Most interviews agreed with Does et al, 2002 that some selection and modification of the tools and techniques was appropriate for using in the HR function;

“You don’t always have to use all the tools in the Six Sigma methodology but some of them are crucial”

“I believe there is a difference in most tools, and some can be used exactly the same for all functions and some have to be adapted and used differently”

“I wouldn’t say a variation of tools, but I would say that you have to “adapt” the tools you have to the area you are working with to get the best out of them”

Although all of the interviewees believed that Six Sigma is an appropriate tool for use in non-technical areas of business, there were a number of criticisms when applying it in this organisation included the time and effort required and that sometimes the results of a Six Sigma project not always warranting the time spent, although this is a common criticism e.g. the Foulkes & Keight study.

“It can be very bureaucratic and time consuming. What I mean is that there can be a lot of certification and tollgates to go through on each project, which can be very time consuming”

“I would say that the main criticism of it is time – it is really time consuming”

“Sometimes the results of using a Six Sigma methodology can be a bit underwhelming too when you look at the time and resources that have been spent implementing it.”

It could be argued that this was a large contributory factor behind the major and unexpected finding of the research that the hegemony of Six sigma was being challenged by the use of other methodologies and tools, in particular Lean.

“If it’s a smaller project though, we can use Lean which is definitely quicker to do.”

“We use Lean to save time, and to knock out unnecessary steps”

“Well I would use Lean for smaller projects as it is a simpler methodology to implement, but for large projects I would always look to use Six Sigma. Time frame is important too – any project less than 3 months in time scale I would probably use lean as a “quick fix” solution”

One respondent, revealing some differences in application between functional areas; made an interesting point;

“Generally non-technical areas of business tend to use Lean more than the Six Sigma”

Compiling the interview data it appeared that the decision of whether or not to apply Six Sigma seemed to depend on three determining factors;

Project Nature

The complexity and difficulty of the project, which in this organisation, was frequently equated to amount of work needed. In addition the problem type was a determining factors, for example Lean was favoured for cycle time projects, while Six Sigma used to reduce defects.

Scale of the Project

This was in terms of geography, the range of functions involved, and the number of in the project team. The larger the project the more likely Six Sigma would be utilised

Time frame of the project

Shorter projects tended to use lean rather than Six Sigma

There appears to be differences in the thoroughness of application of Six Sigma within the same organisation;

“I would look to use the full Six Sigma DMAIC process and follow it rigorously”

“Common sense is the first one – I would always ask myself “do we really need to do this”. After that I would try to see if we could use Lean to solve a problem and failing that I would use the full Six Sigma DMAIC process.”

But also that the hegemony of Six Sigma has only been partially extended to include the lean methodology as well, regardless of the effectiveness of the techniques and the efficiency of achieving project outcomes, as stated by this employee.

“The relation between time spent on a project and the results may sometimes be underwhelming. However managers always want Lean and Six Sigma so it is a must”

Smith (2003) suggested that when looking at Lean and Six Sigma, too many companies believe that they have to choose one approach at the expense of the other. Those that try both often find that they compete for resources, or worse, foster a culture clash (Smith 2003, p41). Smith (2003) goes on to suggest that the *“clash may seem unavoidable. After all Lean programs centre on teamwork and breakthrough events. Six Sigma tends to develop an aristocracy of quality engineers who spend months collecting data and punching into computers, far from the daily work of the shop floor”* (Smith 2003, p41).

One of the main findings of this research is that, in fact, an organisation can run both Lean and Six Sigma and without significant culture clash or clash of interests. The choice of which methodology to run seems to be purely based on the issues of time, resources and the scope of the project, anything else – including which function of business – is deemed to be irrelevant. The findings of this research negate the theory put forward by Bonnie Smith in 2003 and provide evidence that it may be a good practice to provide a range of methodologies and tools and techniques to allow users to implement the most effective and efficient one for their situation.

In fact in this case it seems that a cross pollination of concepts has occurred, an example below of users utilising the DMAIC problem solving structure but with a Lean methodology which addresses one of the problematic observations of the Lean process, (Antony & Escamilla 2003)

“You have to follow the DMAIC process rigorously – even when using Lean rather than Six Sigma, you need to still follow this process”

“Lean can be a good “quick fix” when there isn’t as much time to take over a project, but DMAIC will always be used”

8.5 Critical Success Factors

The top five critical success factors in a HR environment out of the seventeen derived from secondary research, in order, are:

- Good leadership is essential
- Link Six Sigma to customer requirements
- Management involvement / commitment
- Good communication essential
- Culture of organisation

Bonnie Smith (2003) suggested that management involvement and commitment is the most important factor when implementing Six Sigma or Lean (Smith 2003, p41). The quantitative research data found here provides some support for this. These high ranking factors are no different than earlier Quality management frameworks such as TQM, Deming et al as outlined in Oakland (2003). The five least important critical success factors were

- Take a process view to management
- Use of Black belts
- Involvement of all staff
- Linking six sigma to suppliers
- Variation of tools required for certain applications

Interestingly one of the most striking elements of the qualitative data was the ability and propensity to choose and merge between the methodologies, tools and techniques of Lean and Six-Sigma. One success factor, which might have provided a platform for this opinion came last! It is argued here that clearer questioning and an addition of a new CSF for this behaviour may have provided a different response. However it does bring into question the validity of a critical success factor theoretical framework, as it does not necessarily give a true answer to the question: what are the most important factors in implementation of six sigma?

8.6 Managerial Implications

- Allow diversity in tools, techniques and methodologies to allow effectiveness in solving problems but with the most efficient and appropriate techniques.
- Practitioners will be able to develop their own set of criteria to decide what approach, tools and techniques are most appropriate.
- Do not be rigid with methodologies, as practitioners will develop hybrid versions based on strengths and weaknesses of different approaches.
- Be wary of using six-sigma in data poor environments and contexts.
- The 'old chestnuts' of leadership, commitment, culture, customer and communication are more important than the methodologies, tools or techniques.

The future of Six-Sigma in HR, and perhaps other administrative areas, will depend on whether the tools and techniques, and DMAIC methodology are allowed to be used alongside other methodologies, because if managerial control is relinquished the practitioners will choose the most efficient and effective problem solving mechanisms.

8.7 Conclusions

Six-Sigma is used effectively in any non-technological areas of business, such as HR in a European context, although practitioners believe the project must have some measurable aspect to it, in order for it to be suitable. Therefore one challenge in development and further implementation of Six-Sigma in HR is the identification of processes with measurable inputs and outputs, or the ability to devise suitable measurements in other processes.

Some modifications and selection of Six Sigma tools takes place in a HR context, although this is deemed of relative little importance or significant by the users. There are some cross-organisational differences in the extent and depth to which the methodologies and tools are used in projects. However more research could be carried out looking at whether the use of some tools is more prevalent in HR in comparison to other areas.

The hegemony of Six sigma was being challenged, albeit still within a larger scope defined by senior managers, by the use of other methodologies and tools, in particular Lean. The users of these concepts use their ability to choose and perhaps more significantly to merge between the methodologies, tools and techniques of Lean and Six-Sigma, based on three main factors;

- Project Nature
- Scale of the Project
- Time frame of the project

This work could form the start of developing a conceptual model for how managers choose tools and techniques to use within their cultural context. The critical factors involved in Implementation of Six Sigma Programmes can be ranked as identified earlier, but the results although new to Six Sigma literature are not startling when compared to the previous quality methodologies, such as TQM. In addition the findings of these compared with the merging behaviour above gives rise to some concern about the validity of a 'critical success factor' theoretical framework.

8.8 References

Antony, J 2005, 'A Perspective on the Future', *IEE Manufacturing Engineer*, February/March, pp. 12-13.

Antony, J. & Escamilla, JL 2003, *Blending the Best of Lean Production and Six Sigma for Achieving and Maintaining Operational Excellence*, Warwick Manufacturing Group, University of Warwick.

Conorado, RB., & Antony, J 2002, 'Critical Success Factors for the Successful Implementation of Six Sigma Projects in Organisations', *The TQM Magazine*, vol. 14, no. 2, pp.92-99.

- Dale, B 2000, 'Marginalisation of Quality: Is There a Case to Answer?', *The TQM Magazine*, vol. 12, no. 4, pp. 266-274.
- Does et al 2002, 'Comparing Nonmanufacturing with Traditional Applications of Six Sigma', *Quality Engineering*, vol.15, no.1, pp. 177-182.
- Dusharme, D 2001, 'Breaking Through the Six Sigma Hype', *Quality Digest*, November 2001, pp. 64-49.
- Brady, E J., & Allen, TT 2005, 'Six Sigma: A Review and Agenda for Future Research', *Quality and Reliability Engineering*, vol. 22, pp. 1-38.
- Foulkes, M., & Keight, E 2002, 'Consumer Driven Six Sigma Applied to HR at Ford Motor Co.', *Strategic HR Review*, January/February 2002, pp.26-29.
- Henderson, K., & Evans, J 2000, 'Successful Implementation of Six Sigma: Benchmarking General Electric Company', *Benchmarking and International Journal*, vol. 7, no. 4, pp. 260-281.
- Hendry, L., & Nonthaleerak, P 2005, 'Six Sigma: Literature Review and Key Future Research Areas', *International Journal Six Sigma and Competitive Advantage*, vol. 2, pp. 105
- Ingle, S., & Roe, W 2001, Six Sigma Black Belt Implementation, *The TQM Magazine*, vol. 13, no. 4, pp. 273-280.
- Pande, PS., & Neuman, R., & Cavanagh, RR 2000, *The Six Sigma Way: How GE, Motorola and Other Top Companies are Honing Their Performance*, McGraw-Hill, New York, NY.
- Smith, B 2002, 'Lean and Six Sigma - A One Two Punch', *Quality Progress*, April 2003, pp. 37-41.
- Thurston, LD 2006, 'What is Six Sigma and Where is it Going?' *Caribbean Business*, November 2006, pp. 42-43.
- Wyper, B. & Harrison, A. 2000 Deployment of Six Sigma Methodology in Human Resource Function: A Case Study. *Total Quality Management*, Vol. 11, No, 2&5, pp. 720-727.

9 Expected Role of Management Accounting Within The Six Sigma Methodology: Case Evidence

Indra Devi Rajamanoharan*

Faculty of Accountancy and Accounting Research Institute,

Universiti Teknologi MARA,

14th Floor, Menara SAAS, 40450, Shah Alam,

Selangor, Malaysia

E-mail: indra.raj@hotmail.com

Paul Collier and Brian Wright

School of Business and Economics,

Streatham Court, Rennes Drive,

Exeter, EX4 4PU, UK

E-Mail: P.A.Collier@exeter.ac.uk , B.Wright@exeter.ac.uk

Abstract

Drawing on International Federation of Accountants' (IFAC) (1998) conceptual framework for management accounting, this study argues that many of the principal roles in the Six Sigma (SS) DMAIC process fit closely with IFAC's four key roles for management accounting. The results showed that the SS features applicable at all phases of the DMAIC process match closely with IFAC's key roles for management accounting. At the broadest level the case studies illustrated that the role of management accounting had undergone considerable change, in parallel with the changes that were taking place in the wider business activities with the adoption of the DMAIC management process. Changes occurred mainly in the course of project prioritisation (define phase), and in project deployment (measure phase onwards). At both stages SS members focused on a set of standard criteria that link directly to IFAC's best practices of management accounting in terms of the fourteen concepts that form part of the conceptual framework for management accounting. Therefore, the results of this study provide a common understanding of the potentially useful role that IFAC's best practice of management accounting could play in the DMAIC phases.

Keywords: Six Sigma, IFAC, Accounting practices, Business Process Orientation

9.1 Introduction

The International Management Accounting Practice Statement No.1 *Management Accounting Concepts* (IMAPS 1), developed by the International Federation of Accountants (IFAC), describes management accounting by reference to leading edge practice internationally (IFAC, 1998, IMAPS 1:Para. 3). The description of leading edge practices in the statement is supported by a conceptual framework that elaborates the description and serves both as a set of assumptions for reasoning about appropriate directions for practice and as a set of criteria for evaluating good practice (Para. 3). Together the description and conceptual framework provide a benchmark of best practice in management accounting that serves as a resource in developing, understanding and improving practice worldwide (IFAC, Paras. 4, 5, 6).

According to IFAC (1998) best practice in organisations is often interwoven with other distinctive parts of the organisation's management process that are associated with organisational direction setting, structuring, securing commitment, control and change (Paras. 26, 34). In this regard, best practice in management accounting is taken as that part of management process concerned with the use of work technologies and managerial processes that are focused on adding value to organisations by attaining the effective use of resources in a dynamic and competitive setting (IFAC, Para. 28). The concept of best practice in management accounting used in this paper refers to the use of work technologies and managerial processes that are applicable within the SS domain.

The rationale for considering IFAC's best practice of management accounting is that it constitutes part of the best practice recommended by the SS featured DMAIC process which has not been extensively explored in the management accounting literature. Hence, drawing on IFAC's conceptual framework for management accounting (IFAC 1998) this case study based research is focused on the following research questions:

- The extent to which SS implementation involves IFAC's four identified roles for management accounting, and
- The extent to which tools used in the DMAIC process are recognisable as management accounting tools.

IFAC's conceptual framework for management accounting (IFAC, 1998) focuses on four principal roles for management accounting, and the first research question will be examined by reference first to the extent to which SS implementation involves these four identified roles for management accounting, and second the extent to which tools used in the DMAIC process are recognisable as management accounting tools. The examination will result in a framework linking DMAIC stages with specific IFAC management accounting roles and recognised management accounting tools to provide a template illustrating maximum best practice involvement of SS team members in SS implementation.

This paper is organised into three parts. The first part describes in some depth the relevant literature on IFAC's (1998) conceptual framework for management accounting, the DMAIC management process, DMAIC tools and management accounting and the IFAC-DMAIC link. The second part discusses the research methodology. The final part presents the results of the case study analysis and discusses the implications.

Relevant Literature

9.2.1 IFAC'S conceptual framework for management accounting

IFAC's conceptual framework for management accounting describes the functions of management accounting by reference to best practice internationally through the following interrelated concepts:

1. The distinctive *function* of management accounting within the management process in organisations;
2. The way in which the *utility* of work outcomes of the management accounting process can be tested;
3. *Criteria* which can be used to assess the value of work processes and technologies used in management accounting; and
4. *Capabilities* necessarily associated with the effectiveness of the management accounting function overall (IFAC, 1998, IMAPS 1:Paras. 37-71)

In each category of the conceptual framework, IFAC developed associated sub-concepts that elaborated the four main concepts identified in the framework (table 9.1). According to IFAC, the sub-concepts can be used either as a benchmark for best practice in management accounting or as means for managers, accountants, academicians, professional association and others to understand different institutional and cultural approaches taken to management accounting work around the world (Para. 6). Further, the sub-concepts may serve as guides for the evaluation or development of best international management accounting practices, in particular organisational applications, for example in an organisational change management perspective (Para. 73). The paper uses this final function of the framework as the point of reference for establishing the expected roles of management accounting within the SS designed DMAIC management process. Table 9.1 presents the sub-concepts that form part of the conceptual framework for management accounting.

MA Function	Interrelated sub-concepts			
<i>Distinctive managerial function</i>	Resources productivity focus	Value orientation	Business process orientation	Team orientation
<i>Utility of work outcomes</i>	Accountability	Performance criteria	Benchmarking	
<i>Value of work processes and technologies</i>	Equation of resource use and value generation	Management process interface	Technology development and evaluation	
<i>Capabilities required for function effectiveness</i>	Core competences	Critical consciousness	Creating opportunities	Continuous improvement

Table 9.1: The sub-concepts within each category of IFAC's conceptual framework

The sub-concepts identified in table 9.1, besides describing IFAC's best practices for management accounting, provided a number of cues for identifying, testing, assessing and evaluating the existence of management accounting practice within the management process of organisations concerned with effective use of resources and value creation. From a resource and value creation perspective, IFAC noted that organisations attained these through involvement in various organisational and business process change initiatives (Para.34). Given that SS is a recent business process change tool that has been widely used by organisations seeking to locate their business processes along favourable value chains, the management accounting function should be involved in the SS management process provided the IFAC analysis holds true.

9.2.2 The DMAIC management process

The five phase DMAIC management process is the driving force of SS, and it is applied by SS trained teams either for improving a current business process, or improving product/service performance which does not meet customer satisfaction (Stamatis 2005). SS commentators also claim that by moving away from a traditional functional approach to positioning SS within the field of business process management, that organisations achieve optimal results as the DMAIC process has the capacity to identify the causes of business problems and thereby deliver cost savings, increased customer satisfaction and enhanced profitability (Averboukh 2002, Hammer 2002, Lee Beebe 2004).

In deploying the DMAIC process, most SS experts recommend adopting a standard structured method with set steps or tollgates that necessitate the application of key improvement tools and techniques (Breyfogle III 2003, Harry and Schroeder 2000). The structured approach, besides providing a logical roadmap for SS management teams, also promotes the application of best management practices that provide a prescription to achieve breakthrough strategies for SS organisations (Breyfogle III 2003).

9.2.3 DMAIC Tools and Management Accounting

Several management accounting practices (referenced to the Statements on Management Accounting (SMA) principles and practices) have been recognised to complement the DMAIC process. For instance, Gupta (2004), Hammer (2002) and Harry and Schroeder (2000) suggest that a properly executed DMAIC process, should focus on the underlying principles of process management (IMA, 2000), activity based cost management (ABCM) (IMA 1998), and also incorporate techniques like benchmarking (SMA 4V) and the balanced scorecard. Besides the application of management accounting practices, the DMAIC process is supported by a range of process improvement tools.

Generally, SS process improvement tools/techniques fall into two primary types: 1) statistical analysis tools and 2) process optimisation tools (Gygi et al. 2004). From a management accounting perspective, Bromwich and Bhimani (1994) argued that statistical analysis tools as a means of measuring the parameters of a process and assessing variations inherent in the process is well established. Hence, in keeping with such managerial thinking, statistical analysis tools which plays a vital part in the DMAIC process, have been seen as being able to supplement the process management approach as well as activity based costing system (IMA 2000), both of which have been recognised as management accounting practices that complement the DMAIC process for the successful deployment of SS initiatives.

Similarly, process optimisation tools such as cause and effect diagram, failure mode error analysis (FMEA), SIPOC, QFD and process mapping that underpin the DMAIC process are rooted in management accounting practices that complement the DMAIC process. For management accounting decisions, a combination of these tools provides much of the information needed to develop an integrated performance measurement system analysis that supports both process management and/or ABCM practices (IMA 1998) which . For example, the SIPOC tool and process maps are used as high level process management tools at the define phase of the DMAIC process (IMA 2002: Para 58, Hammer 2002) and SIPOC diagrams, process mapping and QFD are also used as planning and control tools for process management and/or ABCM approaches within DMAIC (IMA 2002, 1998).

9.2.4 The IFAC-DMAIC Link

In an identical way to the DMAIC process, IFAC (1998, para.20) holds that within dynamic and competitive organisational contexts organisations should shift from their traditional functional specialisations to a focus on the business processes. Along this line of discussion, the SS literature (manuals and articles) suggests that the criteria/features identified with 1) the selection of project process improvements and 2) the formation of a SS team structure should promote the application of best management practices for SS organisations, thus enabling a link between SS and IFAC's management accounting concepts.

9.2.4.1 Selection of the project

The first step in project selection is to define and process map the business processes to identify areas of weaknesses. The following section links SS processes related to this step with IFAC's description of best management accounting practice in terms of the concepts shown in Table 9.1.

Business process orientation concept

According to IFAC (1998) management accounting work is centred on the core and enabling business processes of an organisation, involving customers, suppliers, and other stakeholders (Para. 46), an approach which is also adopted for SS methodology. From a SS perspective, Smith *et al.* (2002) asserted that in the first step in the project selection process, SS organisations should focus on the business processes, which strongly support their strategic goals (a top-down approach), a position also consistent with IFAC's aims for optimising organisations' business processes (Para. 20). The process ensures that high value and well-balanced SS projects are identified and linked to the company's strategic objectives (Keller 2001, Carey 2007)

Resource Productivity Focus and Value Orientation Concepts

According to IFAC the management accounting process should be focused on the efficient and effective use of resources (Para. 42). Hence, by adopting a business process oriented approach for project selection, SS is also centred on the efficient and effective use of resources. Stamatis (2005) asserted that an effectively managed project based business process, besides ensuring the optimal use of resources, should continuously generate customer and business value for organisations. Therefore, in the first step in the project selection process, SS organisations are also urged to examine the way resources are deployed (resource productivity focus), and consumed by business processes in generating value (value orientation) over time (Pyzdek 2004, Breyfogle III 2003, Swinney 2000). For SS organisations, organisational resources relate to people, facilities, systems, cost and money (Basu 2004) and this is consistent with IFAC's description of resources (IFAC 1998:Para. 31).

Performance criteria concept

Consistent with the IFAC performance criteria concept, SS recommends a wide range of performance criteria at both strategic and operational levels in the first and second steps in the project selection process. In the first stage, Pyzdek (2004) and Phadnis (2003) stressed the importance of having a strategic balanced scorecard for successful SS initiatives. Gupta (2004) added that a properly executed SS strategic business scorecard besides encouraging leaders to uphold profitability should demand a high level of performance from management teams and these views are also shared by IFAC. Further, performance criteria and the systems for monitoring them should be emphasised at the operational project level, during the measure phase and the choice of measure should be closely aligned with their strategic level scorecard (Akpolat 2004). Hence, the IFAC performance criteria concept for project selection is one of many critical success factors for SS initiatives (Smith et al 2002, Gupta 2004, Breyfogle III 2003, Brewer & Bagranoff 2004).

Benchmarking performance concept

According to IFAC (1998: para. 52) the performance objectives used to express management accounting accountabilities within an organisation should reflect the outcomes of benchmarking management accounting work across organisations. Similarly, Harry and Schroeder (2000: 62) claim that benchmarking with external and internal competitors forms an essential part of operating SS in organisations and is a key feature in the project selection and management processes linked to the define, measure and analyse phases of the DMAIC process. Furthermore, to achieve competitive advantage and operational excellence Basu (2004) identified benchmarking as a key step in the project selection process.

Equation of Resource Use and Value Generation

According to IFAC the management accounting process draws on a distinctive mode of thinking, focused on the equation of resource use and value generation over time (Para. 54). SS uses a similar analytical approach in the identification of the critical to quality (CTQs) process characteristics in the second step of the project selection process. In this stage, the identification of process CTQs is centred on a simple performance equation, $y = (f)x$, where at the strategic (macro) and operational (micro) levels, a business process output, y , is stated as a function (f) of the process input resources, (x) (Gygi et al 2004). Like IFAC (Para. 32, 36, 56, 57), most SS practitioners also suggest that organisations should first identify a set of strategic level process CTQs characteristics that significantly impact on customer satisfaction, and stakeholder and business profitability, and form the basis for operational level project CTQs (Stamatis 2005, Gygi et al 2004). By adopting this approach both SS and IFAC believe that both customer and other stakeholder needs could be effectively met.

Critical consciousness

IFAC's critical consciousness is a generic concept that is applicable to all management activities (Para. 70), and the SS management activities are no exception. For instance, Gupta (2004) and Akpolat (2004) stressed that during the second step process of identifying CTQ characteristics, SS management teams should have a clear understanding of business processes and possess a strong 'critical consciousness' as otherwise selected projects may not have the predicted impact on business results or may achieve only insignificant improvement to process. While, George (2003) added that throughout the DMAIC process SS management besides developing a rigorous culture for identifying, scoping and selecting projects should at all times possess a critical mindset for taking decisions that concern value added and not activities.

Seeking Opportunities

Seeking opportunities is another generic concept applicable to management activities. IFAC suggest that a management accounting function should embody a culture of pro-activity, in seeking out and finding opportunities for value creation within organisations (Para. 67). Similarly in SS, SS management are urged to use brainstorming sessions to identify opportunity areas within the organisation, which they believed were critical to business performance (Stamatis, 2005, Gygi et al 2004, Phadnis, 2004). For instance, when seeking opportunities, Phadnis (2004) suggests that project priority should be given to critical business processes that currently indicate a low to medium level of performance, but have a medium to high impact on overall business performances.

9.2.4.2 SS team Structure (*Team Orientation concept*)

The selection of the SS team structure is the second key issue addressed as part of the DMAIC define process. IFAC also recognised that the management accounting process is deployed and conducted through various types of teams (Para. 47). Further, IFAC pointed out that management teams besides having a strategic, managerial or operational focus should also have a task, process or cross-functional orientation (Para. 47). Similarly, SS organisations are urged to develop a top-down team approach to undertake process improvements within the organisation and at project level cross-functional teams are responsible for the successful completion of improvement projects (Knowles *et al.*, 2004; Breyfogle III, 2003; Antony and Banuelas 2002; Harry and Schroeder, 2000). Hence, IFAC team orientation concept is represented within the define phase of the DMAIC process.

Management interface, Accountability and Continuous Improvement

The IFAC management interface and accountability concepts are generic concepts applicable to management activity, which can be directly associated with a SS team infrastructure. Management accounting requires close links with management and accountability as does SS. For example, Breyfogle III (2003) stated that a SS cross-functional team facilitated communication with management from other parts of the organisation, and led to optimal results through a more effective management of cross-functional business processes.

Stamatis (2005) suggested that SS team members should be held personally accountable for project completion and achieving the performance improvement goals they set for their respective business units or departments. A position echoed in IFAC's description of accountability (Para. 50). Similarly, IFAC's views on empowerment and reward systems are central to SS (Para. 50-52). For example, Gupta (2004) held that for optimal results SS team members should be fully empowered and that to ensure greater accountability their joint efforts should be linked to a reward/incentive system. Finally, to sustain continuous improvement, Gygi et al. (2004) suggest that process owners as custodians of a particular process should be held accountable for completed projects and the IFAC continuous improvement concept upholds a similar culture.

Core Competence

Amongst other things, IFAC associated core competence with the expertise and skills of staff and the interactive work processes used (Para. 64). These concepts are also applicable for assessing SS team skills. Therefore, besides individual accountability, an organised team approach for continuous process improvement demands a high level of competence from the management team involved in the application of a range of tools and techniques (Basu 2004). Basu (2004) suggests that all SS members should be trained to use the tools and techniques, to a level of competence that ensures optimal results. Gupta (2004) added that a lack of competence from SS teams might lead to conflicting priorities and fragmented deployment of resources and efforts. Hence, throughout the DMAIC process the core competence of SS team is in part assessed by their ability to effectively apply SS related tools and techniques for SS.

9.2.4.3 Summary

Overall, the examination of the literature culminated in the development of a framework that postulates that the DMAIC managerial processes and work technologies fit closely with IFAC's management accounting concepts (refer to figure 9.1). Thus, in figure 9.1 the framework for DMAIC-IFAC practice provides a template for illustrating best practice involvement by SS teams in SS implementation.

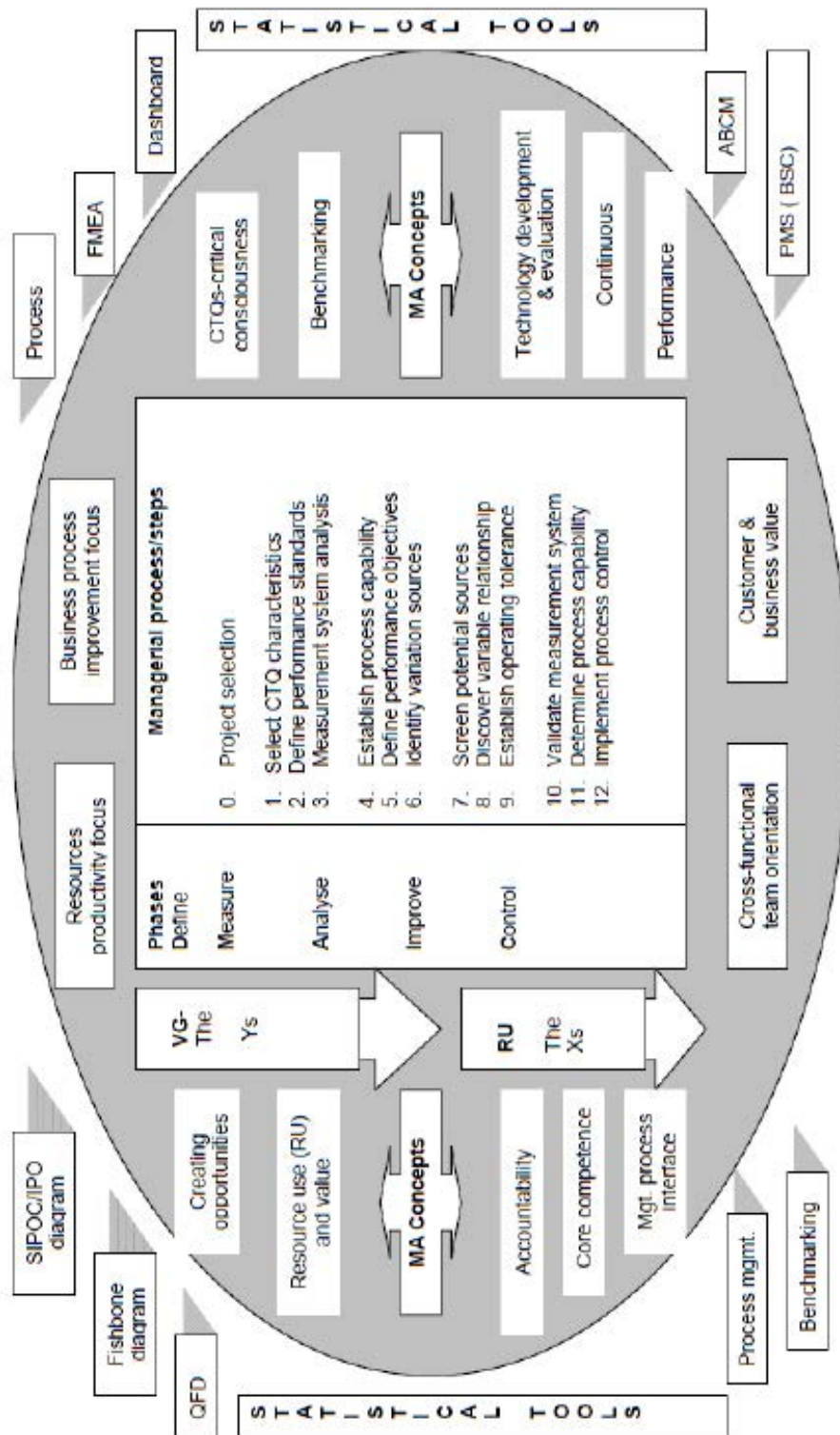

Figure 9.1: A framework for DMAIC-IFAC practice

In figure 9.1 the DMAIC managerial process, which begins with the define phase and ends with the control phase, involves thirteen managerial steps (0 to 12). IFAC's management accounting (MA) concepts as identified in Figure 1 are initiated by SS teams in all phases of the DMAIC process. The figure also shows that, the DMAIC managerial process and the accomplishment of IFAC's management accounting concepts are facilitated by adopting various management accounting techniques in association with a range of process improvement tools for the effective management of SS initiatives. Together, the DMAIC process, and the related management accounting tools and techniques form a template for illustrating maximum best practice involvement by SS members (project champions, black belt/ green belt project leaders), in SS implementation.

9.3 Research Methodology

A case-study approach has been used to address the issues identified in the research. Scapens (1990) argued that case studies are particularly appropriate in areas where theory is not well developed and that they are a basis for scientific research. Yin (1994) classified case studies into explanatory, descriptive and exploratory approaches. Yin (1994 p.7) states that to differentiate among these approaches, it is necessary to examine the type of research question being posed. The two questions in this paper are essentially 'what' questions, and Yin associates these with an exploratory research approach. Therefore, an exploratory approach is used in this study to examine the research issues.

This paper presents the evidence obtained from two case study companies (hereafter referred to as Company A and B)[□] in the services sector in Malaysia. The two firms were chosen because they provided a good illustration of the possible differing issues that may reflect the implementation process of locally owned companies and foreign owned subsidiaries. A multiple case study approach allowed for a more direct comparison of the similarities and differences between the implementation practices in different organisational contexts (Silverman, 2000).

9.3.1 Data collection and analysis

Access to the companies was obtained through direct contact between the researcher and the companies. The main source of data for this study was the personal interviews with 13 and 7 members of the SS team at Company A and B respectively. To eliminate any bias by a single respondent, attempts were made to ensure triangulation of data from multiple sources within the SS team structure. As a result, the SS respondents comprised of six senior managers appointed as SS champions, and fourteen managers and executives; eight trained as SS black belts and the other six as green belts. The SS champions were the project sponsors, while the SS trained black belts and green belts, were appointed as project leaders responsible for the successful completion of SS projects.

The personal interviews with the SS teams at Company A and B were supplemented by studies of annual reports, newsletters and information from the company's website. An extensive review of the SS literature surrounding the research questions was undertaken before developing the interview questions. The interviews made use of a semi-structured approach, the structured component of which served as a guideline for consistency and cross-referencing. The interview involved asking the questions, elaborating and probing where necessary. The whole data collection process involved tape recording, taking notes and viewing/collecting documents relevant to the SS implementations. To put the managers at ease, the purpose of the interview was explained to the respondents. To avoid biased responses, no attempt was made to reveal the objectives of the study.

9.4 Findings

9.4.1 The case study companies

Company A undertakes a range of principal activities in the service sector through a number of subsidiaries. A minority of its subsidiaries have been awarded the ISO 9001 certification and one has had its certification upgraded from the 1994 version to the 2000 version in the 2003 financial year. The introduction of the SS initiative within the group and its subsidiaries reflected an intention to move beyond ISO 9001 compliance and to focus on customer driven activities and improve current business processes.

Company B was originally a locally owned business. In 1997, a US based multi-national company, acquired control through the purchase of a 70% stake in the company. The company's name was subsequently changed and a parent company representative was appointed to manage the operations. The parent company incorporated various restructuring and change management programmes, to ensure that Company B did not get isolated from the parent's built-in values and culture. One of the initial change management programmes introduced at Company B was the SS methodology, which was implemented as a company-wide initiative by the parent company.

9.4.2 Best Practices and Tools and Techniques used within the DMAIC Process

In both case firms, SS teams used a set of standard structured steps within the DMAIC process to guide process improvements in all areas of their organisation. As postulated in the DMAIC-IFAC framework (Figure 1), IFAC's management accounting best practice (concepts) can be found at all stages of the DMAIC process. Although IFAC's concepts are linked to all phases of the DMAIC process, SS project leaders interviewed asserted that the initial steps in the Define phase, besides encouraging a top-down management approach, should promote the application of best management practice from SS organisational leaders (SS champions), and subsequently demand high levels of performance and participation from SS teams involved in the project deployment stages (MAIC) of the DMAIC process. Given this view, in this paper the DMAIC process is used as a framework, for discussing the research questions posed in this study.

9.4.2.1 Define Phase

In figure 9.1, the define phase, which was perceived by SS teams as the most critical phase within any SS project, is the first phase in the DMAIC process. At this phase, the SS team members undertook a significant role in SS project decisions. From a SS project decision perspective, SS team members at Company A and B undertook roles in the identification, prioritisation and validation of SS opportunities (projects) in the company.

Identification and prioritisation of projects

At Company A, the finance and department heads were appointed as project champions (members) and were directly involved in the identification and prioritisation of projects. The identification and prioritisation of projects at Company A was carried out during the firms' strategic planning session. The process involved an intensive brainstorming session among senior management who examined existing processes with the objective of identifying areas of inefficiency and costs overruns. Consistent with the literature, when targeting project based process improvements SS members at Company A were urged to focus on the business processes, which strongly supported their strategic goals (a top-down approach), a position also consistent with IFAC's aims for optimising organisations' business processes (Para. 20). The process ensured that high value and well-balanced SS projects are identified and linked to the company's strategic objectives.

The practice of focusing on business processes is consistent with the underlying principles found in process management practices which fall within the ambit of management accounting techniques. According to a SS member at Company A, SS members seeking possible opportunities, moved away from their traditional functional decision process to improving processes within various business functions.

The prioritisation of projects in these firms culminated with the development of a several project team charter that endorsed a team-based problem solving approach in the finance function. The project charter stated the scope and boundaries of each project and identified the members of the SS team. According to the members at Company A, all projects were prioritised on the basis of their likely impact on bottom-line performance, a position consistent with IFACs performance criteria concept.

At Company B the prioritisation of projects in the finance function was also undertaken by green belt members, and like Company A the prioritisation of projects in this firm also culminated with the development of a project charter. The SS policies and the project prioritisation decisions at Company A was constrained by a set of SS goals, which had been set and communicated to the subsidiary by top management at the parent company level. This top-down deployment approach conforms to recommendations in the SS literature (Breyfogle III, 2003).

Criteria for project prioritisation

A standard procedure adopted during the project prioritisation process was the identification of critical business processes that incurred costs overruns and caused wastage. Thus, the SS team members, while targeting process improvements, undertook a critical assessment of firm processes with a view to eliminating non-value added activities in the finance and wider business functions. In the course of project prioritisation, and subsequently in project deployment (measure phase onwards), the team members focused on a set of standard criteria that closely fitted with the following IFAC best management accounting practice concepts:

- The search for process improvement opportunities links directly with IFAC's creating opportunity concept. The process involved an assessment of the current finance function processes and the identification of possible opportunities for improvement in relation to company goals to ensure the optimal use of process resources. In the course of seeking opportunities, Company B also used inter-division benchmarking to identify performance gaps in the finance processes, a best practice recommended by IFAC. However, due to the absence of clear comparative information, the SS members at Company A set their own targets when determining process performance gaps.

- The mapping and targeting the critical processes that affected customer satisfaction and bottom-line results in both their organisation are consistent with IFAC's best management accounting practices in terms of the business process orientation, customer and business value creation concepts and also promote critical thinking among members.
- Identifying a set of SS performance criteria that closely aligned with corporate goals. For Company B, SS performance criteria were determined by top management at parent company level and Company A such measures were determined by senior management who headed key areas within the organisation.
- Focusing on an SS performance equation, $y=f(x)$ where, the key output of a process (Y), is the function (f) of the resources input into a process (x).
- To ensure the effective management of business resources is consistent with the resources productivity focus, equation of resources use and value orientation concepts recommended by IFAC.
- The use of a team based approach for solving business processes problems. For cross-functional process improvements the members of the team comprised staff from cross-functional backgrounds. At the time of the investigation, this approach was found in the more experienced parent-led firm Company B. The cross-functional team approach besides encouraging SS members to interface with SS members from other areas of the organisation also ensured that targeted projects achieved optimal results, and such an approach directly links to IFAC's best management accounting practices in terms of the team orientation concept identified in figure 9.1.

Validation of SS projects

In both firms, the SS members were also involved in the validation and tracking of potential project savings. The process involved tracking potential project savings to the firm's bottom-line performance, as improvement in profitability was the key criteria for project prioritisation. This approach is consistent with Breyfogle III (2003) and Gupta's (2004) recommendations that SS projects should be aligned closely with company's financial goals, thus fulfilling IFAC's value creation role.

9.4.2.2 Measure Phase

The SS members at both firms, were directly involved in the deployment of the projects in the finance and wider business activities, and this entailed them being actively involved in the DMAIC measure phase. From SS project decision point, the members were involved in the following roles in the measure phase:

Identification of critical process activity

In measure phase it was necessary for SS members to ascertain the critical activity within the business processes that was incurring costs overruns. The identification of critical process activity began with the collection of relevant data by team members. The SS members at both firms claimed that this step was the key to understanding the process irregularities in the business processes. Besides the identification of critical process activities, the members were also involved in the measurement of key activities within a process, with the objective of establishing a baseline measurement and for assessing the current performance of each process activity. In the course of identifying the critical process activities, the members fulfilled IFAC's performance criteria and critical consciousness concepts.

According to a SS member at Company B, baseline data was used to seek the possible opportunities available for improving a process, a view that was also shared by other members. While focusing on a data driven decision approach, SS members were focused on seeking opportunities that created value through the efficient use of resources within the finance function and this approach closely matched with IFAC's best practice of management accounting, in terms of the value creation, resource productivity focus and creating opportunity concepts.

For identifying the critical activities, SS members in both firms used tools such as process mapping and cause and effect diagrams. These tools helped the team to identify the possible causes affecting the performance of finance processes. The SS members interviewed explained that the project decision making process was centred on the standard SS performance thinking $y=f(x)$ that closely fitted with IFAC's equation of resources use and value creation concept which has been identified in the framework in figure 9.1. By adopting this approach, the SS members at both firms were involved in a critical decision making role that involved identifying the most critical activities within the processes. The SS members held that only non-value adding process activities that had the highest impact on the performance finance processes were targeted and this practice matched with the underlying principles found in process management and ABCM practices.

Project measurements and performance standards

Another key task for SS members was developing appropriate project measurements and performance standards for SS projects and this matched with IFAC's performance criteria and benchmarking concepts identified in Figure 1. The choice of measurements besides reflecting the outcome of a particular project, were closely aligned with company goals. Company B also benchmarked their project performance against inter-divisional best practices, an approach that is strongly recommended by SS practitioners. However, due to the absence of comparative information project benchmarking was not possible at Company A. Instead, the SS members at Company A assessed the average baseline project performance and established a reasonable performance standard above the current average.

9.4.2.3 Analyse Phase

The SS members at both firms undertook the following analytical roles in this phase:

Identification of root causes of defects

SS members reported that the first task in analyse phase, was to determine the root causes of process defects affecting process capability (project performance). An approach directly linked with IFAC's equation of resource use and value creation concept. The process involved the use of various statistical control tools. The members possessed a working knowledge of the basic statistical tools that were essential for a data driven decision approach. The SS members believed that there were often more than one root causes of process defects, and that therefore it was important for the SS team to select the appropriate statistical tools to be able to distinguish between the general causes and main causes. This approach is similar to ABCM principles where the procedure involves the identification of various forms of wastage that may occur within a process (Glad and Becker 1994).

Determine source of process variation

According to the SS members interviewed, it was important for them to target the vital few sources of process variation that significantly impacted on project performance. Tools used by SS members to analyse process defects included Pareto charts, and the Failure Mode and Effect Analysis (FMEA) diagrams. For analysing very complex processes, the members had the option to use various statistical software packages. Most SS Members reported that prior to adopting SS methodology they in their role as accountants and company executives had rarely used statistical tools. Hence, they had limited knowledge of the use of statistical tools and often sought advice from the engineering staff when dealing with complex issues. A position reflected in IFAC's core competence concept.

Monitor activity costs and savings

SS members stressed the need to conduct process performance gap analysis that mirrors IFAC's performance criteria and benchmarking concepts. The aim was to identify and monitor the activity costs and savings of potential SS projects. By determining the gap between the current and desired state, the SS members established the process capability of specific finance function projects. For this exercise, tools and techniques such as benchmarking and FMEA diagram were widely used. For instance, at Company B, the desired state was determined through a process of inter-company benchmarking as discussed in define, and measure phases, but for Company A the desired state represented any reasonable improvement to the current state.

9.4.2.4 Improve Phase

As in figure 9.1, the fourth phase involved the improve phase. In this phase the SS members at both firms were involved in the selection of an optimal project improvement solution. The process involved an intensive brainstorming session among members who identified and evaluated possible solutions with the objective of improving customer satisfaction and increasing bottom-line results. Besides conducting brainstorming sessions, the members also used various tools such as process mapping and FMEA diagrams to identify alternative improvement plans that added value to their finance processes. The 'members' project decisions taken at this stage were facilitated by the information obtained during measure and analyse phases. The members search for an optimal solution closely links with IFAC's core competence and accountability concepts. According to a member at Company B, selection of an optimal solution was often supported with a simple cost benefit calculation. Although members from Company A claimed that they followed a similar approach, there was no documentary evidence to support this claim.

9.4.2.5 Control Phase

In the control phase, the SS members from both firms, evaluated and validated the actual savings obtained from SS projects. The SS members in both firms were responsible for meeting the targeted project goals, which had been defined by them. Their responsibility can be associated directly with IFAC's accountability concept. In Company B, the members compared the actual project performance against desired targets. In contrast, the members from Company A used a 'before SS' and 'after SS' evaluation approach to determine the performance of projects and merely sought evidence of some improvement. Finally, to sustain continuous improvements, control systems such as post implementation audits and/or a process control plan were put in place at Company A. SS practitioners for example Pyzdek (2004) and Breyfogle (2003) recommend the use of dashboard controls to monitor SS progress, but at the time of the investigation there was no evidence of such practice at Company A.

9.4.3 Summary

Table 9.2 summarises the interaction between SS team members and IFAC's best practices of management accounting (concepts), and by reference to the five stages in the DMAIC process.

Stages / Role	SS team Members	Tools and techniques	IFAC concepts
Define	<ul style="list-style-type: none"> identify and prioritise projects and validate 	<ul style="list-style-type: none"> Process management 	<ul style="list-style-type: none"> creating opportunity business process orientation value creation critical consciousness resource productivity concept equation of resource use and value creation management process interface team orientation accountability benchmarking & performance criteria
Measure	<ul style="list-style-type: none"> identify critical process activity develop measurements/set performance standards for selected projects 	<ul style="list-style-type: none"> Process management ABCM process mapping Cause and effect diagrams 	<ul style="list-style-type: none"> team orientation value creation resource productivity focus creating opportunity equation of resource use and value creation benchmarking & performance criteria
Analyse	<ul style="list-style-type: none"> identify root causes of process defects determine process variation monitor process activity costs and savings 	<ul style="list-style-type: none"> FMEA diagrams ABCM Cause and effect diagrams Pareto charts 	<ul style="list-style-type: none"> Equation of resource use and value creation benchmarking & performance criteria
Improve	<ul style="list-style-type: none"> select optimal improvement solution for selected projects 	<ul style="list-style-type: none"> Process mapping FMEA diagrams 	<ul style="list-style-type: none"> Core competence Accountability
Control	<ul style="list-style-type: none"> validate project savings and sustain continuous improvement 	<ul style="list-style-type: none"> post-implementation audits process control 	<ul style="list-style-type: none"> Accountability Continuous improvement

Table 9.2: The DMAIC-IFAC best practice of management accounting

Overall, table 9.2 shows that SS member roles in the DMAIC process involve many aspects that fall within the IFAC management accounting concepts previously discussed. Both IFAC and SS are centred on a common business process orientation approach for value generation. By positioning SS within the field of business process management the case study illustrated that the DMAIC process interfaces with best management accounting practices and management accounting tools and techniques to identify the causes of business problems and thereby deliver cost savings, increased customer satisfaction and enhanced profitability. This approach was applied widely by SS teams targeting project based process improvements in the finance and wider business activities.

9.5 Conclusion

The paper posed two research questions. The conclusions drawn on each are as follows:

IFAC's four identified roles for management accounting and DMAIC

The results have shown that the SS features applicable at all phases of the DMAIC process match closely with IFAC's four key roles for management accounting. Both IFAC and SS are centred on a common business process orientation approach for value generation. By positioning SS within the field of business process management the case study illustrated that the DMAIC process and tools interfaces with best management accounting practices to identify the causes of business problems and thereby deliver cost savings, increased customer satisfaction and enhanced profitability. This approach was widely applied by SS teams targeting project based process improvements in the finance and wider business activities. Overall, this research which reinforces the views of previous studies on the evolving role of management accounting, culminated in the development of the IFAC-DMAIC conceptual framework (figure 9.1).

At the broadest level the case study also illustrated that the role of management accounting had undergone considerable change, in parallel with the changes that were taking place in the wider business activities with the adoption of the DMAIC-IFAC management process and tools. Changes occurred mainly in the course of project prioritisation (define phase), and in project deployment (measure phase onwards). At both stages SS members focused on a set of standard criteria that link directly to IFAC's best practices of management accounting in terms of the concepts identified in Table 1. Therefore, the results of this study provide a common understanding of the potentially useful role that IFAC's best practice of management accounting could play in the DMAIC phases.

DMAIC tools recognisable as management accounting tools

Consistent with the literature, both statistical analysis tools as a means of measuring the parameters of a process and assessing variations inherent in the process, and process optimisation tools such as SIPOC, process mapping, cause and effect diagram and FMEA tools widely used by SS teams for process planning, control and decision making were well established in the DMAIC-IFAC management process adopted by Company A and Company B. Consistent with the principles of process management and/or ABCM, for SS initiatives, each failure mode is ranked for severity of the effect on performance, frequency of occurrences of its causes and detection of the failure mode based on the effectiveness of the control methods. Overall by adopting this approach and tools, SS focuses on the capacity, costs, quality and responsiveness of the process, which represent the key elements that are measured and compared to define customer needs. These elements are also the concern of management accounting.

9.6 References

Akpolat, H 2004, *Six Sigma in transactional and service environments*, Gower Publishing Ltd., England

Antony, J., & Banuelas, R 2002, 'Key ingredients for the effective implementation of six sigma program', *Measuring Business Excellence*, vol.6, no.4, pp.20-27

Antony, J., & Banuelas, R 2002, 'Critical success factors for the successful implementation of six sigma projects in organisations', *The TQM Magazine*, vol.14, no.2, pp. 92-99.

Averboukh, E 2002, 'Six sigma trends: next generation of projects', [Online]. Available from: <http://finance.isixsigma.com> (Accessed on 19 March 2006)

Basu, R 2004, 'Six Sigma to Operational Excellence: role of tools and techniques', *International Journal of Six Sigma and Competitive Advantage*, vol.1, no.1, pp. 44-64.

Brewer, P., & Bagranoff, NA 2004, 'Near Zero-defect accounting with Six sigma', *Journal of Corporate Accounting and Finance*, vol.15, no.2, pp.37-43.

Breyfogle III, FW 2003, *Implementing six sigma*, John Wiley, New York.

Breyfogle III, FW 2002, 'Golf and Six sigma', *Quality Progress*, vol.35, no.11, pp.83-86.

Bromwich, M., & Bhimani, A 1994, *Management Accounting pathways to progress*, London, Chartered Institute of management Accountants.

Carey, B 2007, 'Business process reengineering in a six sigma world', [Online]. Available from: <http://www.finance.isixsigma.com> (Accessed on 26 January 2007).

Faltin, FW., & Faltin, DM 1999, 'Six sigma, financial reporting and corporate governance: The shape of things to come', [Online]. Available from: <http://www.bettermanagement.com> (Accessed on 13 October 2005).

Feltham, GA & Xie, J1994, 'Performance measures congruity and diversity in multi-task principal/agent relations', *The Accounting Review*, vol.69, pp.429-453.

Fitzgerald, L., & Moon, P 1996, *Performance measurement in service industries: Making it work*, The Chartered Institute of Management Accountants, London.

Finney, J. (2004) 'The topic: SS adoption and cultural issues', [Online] Available from: <http://www.finance.isixsigma.com> [Accessed 27 October 2005].

Glad, E., & Becker, H 1995, *Activity based costing and management*, John Wiley and Sons, New York.

Gupta, P 2004, *SIX SIGMA Business Scorecard- Ensuring Performance for Profit*, McGraw-Hill, New York

Gygi, C., DeCarlo, N., & William, B 2005, *Six Sigma for Dummies*, Wiley Publishing Inc., Indianapolis.

Hammer, M 2002, 'Process Management and the Future of Six Sigma', *MIT Sloan Management Review*, vol.43, no.2, pp.122-132.

Harry, M., & Schroeder, R 2000, *Six Sigma: The breakthrough management strategy revolutionising the world's top corporations*, Doubleday, NY.

IFAC 1989, 1998, 'Management Accounting Concepts', *International Management Accounting Practice Statement*, no.1, First issued February 1989, Revised March 1998

IMA 2000, Statement on management accounting, Statement Number, 4NN, Practices and Techniques: Implementing process management for improving products and services, Institute of Management Accountants, Arthur Anderson LLP, Consortium for Advanced Manufacturing, International.

IMA 1998, Statement on management accounting, Statement Number, 4EE, Practices and Techniques: tools and techniques for Activity based cost management Designing an integrated cost management system for driving profit and organisational performance, Institute of Management Accountants, Arthur Anderson LLP, Consortium for Advanced Manufacturing, International.

IMA 1998, Statement on management accounting, Statement Number, 4EE, Practices and Techniques: tools and techniques for Activity based cost management Designing an integrated cost management system for driving profit and organisational performance, Institute of Management Accountants, Arthur Anderson LLP, Consortium for Advanced Manufacturing, International.

Keller, P 2001, 'Recent trends in six sigma', *Annual Quality Congress Proceedings*, Atlanta, 98-102. company, New York.

Lee Beebe, T, 'Important to understand the process before improving it', [Online] Available from: Available from: <http://www.isixsigma.com> (Accessed on 10

October 2005)

Leonard, FS., & Sasser, WE 1982, 'The incline of quality', *Harvard Business Review*, vol.60, pp. 163-171.

Leahy, T 2005, 'In Search of Perfection with Six Sigma', [online]. Business Finance. Available from: <http://www.bfmag.com/magazine/archives/article.html> [Accessed 1 May 2005].

Lenhardt, PM., & Colton, SD 2000, 'Dispelling two myths of modern cost management', *Journal of Cost Management*, September/ October, pp.21-23.

Lin, AC 1998, 'Bridging positivist and interpretivist approaches to qualitative methods', *Policy Studies Journal*, vol.26, no.1, pp.162- 177.

Linderman, K., Schroeder, RG., Zaheer, S., & Choo, AS 2003, 'Six sigma: a goal theoretic perspective', *Journal of Operations Management*, vol.21, 193-203.

Littleton, AC 1933, *Accounting Evolution to 1900*, American Institute Publishing Company, New York

Luft, JL 1997, 'Long-term change in management accounting: Perspectives from historical research', *Journal of Management Accounting Research*, vol.9, pp.163-198.

- Phadnis, S. (2003) 'Selection of Project Metrics', [Online]. Available from: <http://www.isixsigma.com/library/content> [Accessed 27 October 2003].
- Phadnis, S. (2004) 'Six Sigma deployment', [online]. Available from: <http://www.isixsigma.com/library/content> [Accessed 19 March 2006].
- Pyzdek, T 2004, 'Strategy deployment using balanced scorecard', *International Journal of Six Sigma and Competitive Advantage*, vol.1, no.1, pp.21-28.
- Scapens, R 1990, 'Researching management accounting practice: The role of case study methods', *British Accounting Review*, vol.22, pp.259-281.
- Silverman, D 2003, *Doing qualitative research: A practical handbook*, Sage Publications, London.
- Simmonds, K 1981, *The fundamentals of strategic management accounting*, ICMA Occasional paper series, London. ICMA
- Smith, D., Blakeslee, J., & Koonce, R 2002, *Strategic Six Sigma: Best practices from the executive suite*, John Wiley and Sons, New York
- Stamatis, DH 2003, *Six Sigma for financial professionals*, John Wiley and Sons, New Jersey
- Swinney, Z 2000, 'Process management right for you?' [Online]. Available from:
<http://finance.isixsigma.com> (Accessed on 19 March 2006)
- Yin, RK 1989, 1994, *Case study research: Design and Methods*, Sage Publications, London, England

10 What Makes Lean / Six Sigma Succeed

Experiential Improvement Strategy (Model) – A Case Study

Alan Harrison, FCQI, CQP, MIET, C.Eng

E-mail: alan@leanthinking.co.uk

Abstract

This paper presents pragmatic and experientially developed business improvement model that quickly and positively influences mind set, aligns people, drives right actions and behaviour, and delivers and sustains desired improvements. The model was developed and applied in an international organisation that successfully manage change in a traditional engineering environment through adapted Toyota Production System, Lean, Kaizen, Six Sigma, benchmarking...which are integral parts of their overall business improvement strategy. The main drivers for applying and developing this approach were: need to focus improvement activities on true customer, market and business improvement needs; re-align organisation from traditionally (functionally) structured to value stream organization; get all functions to define and share improvement goals (vision); break functional barriers and get all functions to work together along value stream to own and sustain new system. The key steps of the model are explained with a particular focus on how to achieve and sustain the system that drives desired way of thinking and behaviour with examples of achieved benefits.

Keywords: Rapid Improvement, Kaizen, Lean Leadership, Six Sigma, Value Stream Mapping

10.1 Introduction

10.1.1 Common causes of success and failure

During the last 20 years the author has participated in hundreds of improvement projects across different organisations, engineering, manufacturing, service, private and public...and has experienced many great successes, but also many occasions where efforts did not produce desired outcomes. He has also attended a number of national or international conferences dedicated to business improvement, met many enthusiastic and inspiring practitioners and asked them the same questions. One of the questions was: *“What, in your experience and opinion, makes or breaks improvements?”*

All practitioners gave the same answer: “People”

Based on this (unofficial) survey and years of business improvement experience, the author has developed hypotheses that the root cause of any success and failure is the same, and it is a mind-set, the way how and what we think, as presented below. Common causes of a failure can be categorized as:

- Lack of leadership – lack of individuals who have imagination to create the right vision, charisma to inspire people and energy to drive realisation of that vision
- Limiting beliefs that prevent people to listen, understand, accept and believe in the right vision
- Negative emotions that prevent individuals to have confidence to drive themselves and support others in new direction and take failures as learning opportunities
- Ineffective strategies and plans that fail to identify and realize right improvement actions

Common principles of success can be described as follows.

- Goal focus
 - Recognise your customers and your business real needs. This is the first step in creation of the right vision.
- Take massive action
 - One implemented action is better than a hundred good intentions.
- Know where you are
 - Understand your starting and end positions, track you progress during your journey.
- Be flexible
 - Keep focus on your goals, and also keep flexibility during your journey. The goal of an improvement project is to deliver improvements, not to practice Lean or Six Sigma.
- Start and operate from a physiology and psychology of excellence
 - This is about ‘winning mind-set’. Imagine and behave like you have already achieved your goals. This makes you more confident and it makes all barriers look solvable.

Another question that the author asked business improvement practitioners was: *“What percentage of success would you allocate against ‘soft’ improvement elements, where ‘soft’ stands for leadership, direction, team building, communication...and similar against ‘hard’ improvement tools?”* So, before their answers is quoted - what do you think, in your own experience, what percentage of successful improvement activity is due to ‘soft’ elements? Amazingly, all practitioners (not even almost all, but literally all) gave the same answer, which is “I would allocate 70%-80% against ‘soft’ elements” (Possible explanation could be that Pareto 80/20 rule has become common sense).

The author has interviewed business improvement practitioners in a period 1998 - 2008 during his benchmarking visits to other organisations in the UK and Europe, chairing Lean Six Sigma Club in Glasgow (approx. 25 UK organisations), and internal practice sharing. A number of interviewed individuals are approximately 280. So, if 70-80% of success (according to interviewed business improvement practitioners) depends on ‘soft’ issues, why is it that we usually spend 70-80% of improvement training and execution effort focusing on ‘hard’ issues? (this practice was also confirmed by majority of interviewed business improvement practitioners). Is this your experience as well?

10.2 The three elements of Lean / Six Sigma Success

Again, based on years of personal business improvement experience and feedback from hundreds of peers, the author suggests the following model, as presented in the figure 10.1.

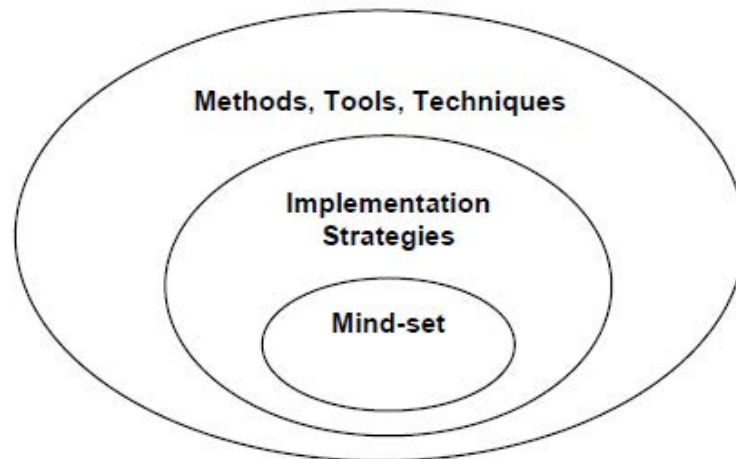

Figure 10.1: The three elements of Lean / Six Sigma success

10.2.1 Mind set

Mind set consists of set values, beliefs and attitudes. Those are widely published and recognized, for example Deming's '14 points'. The following statements and comments present example of required mind-set for successful Lean / Six Sigma implementation.

- **There is no failure, only feedback**

This is a core value of any continuous improvement mind set. It is based on the fact that when a failure happens it is already in the past and we cannot change the past. Undesired outcomes are best seen as learning points which offer opportunities to define and complete right corrective, containment and preventive actions so we do improve present and the future.

- **You get more of what you focus on**

...or...energy flows where attention goes. Desired outcomes are easier achieved when there is a consistent focus on those outcomes.

- **If what I'm doing is not working I will do anything different until I get the response I want**

During an improvement journey, leaders, facilitators, and team members need to be flexible and change roads when required to reach desired outcomes in effective, efficient and ecological way.

- **You cannot not communicate**

Communication is important part of any improvement activity. Any gaps and holes in communication tend to be filled in by rumors, which may harm desire for improvement.

Business leaders are responsible to consistently demonstrate desired mind-set and demand desired outcomes in a positive way.

- **People are victims of broken processes.**

The root causes of undesired outcomes are in the process, the system the way how work flows, not in the people. People are part of the process and they will do their best in their own model of the world. It is better to aim for perfect processes supported by average or above average people than the other way around.

- **Lean / Six Sigma practitioner is one who demonstrates Lean / Six Sigma**

The operative word is 'demonstrates' which makes the difference between Lean / Six Sigma practitioner and someone who has knowledge of Lean / Six Sigma.

10.2.2 Implementation Strategies

The next element of successful Lean / Six Sigma implementation is how change is put in place, i.e. 'a recipe' how Lean / Six Sigma is deployed. There are probably as many ways to implement Lean / Six Sigma as organisations doing it. Some important elements of any Lean / Six Sigma implementation are as follows:

- Top management vision and participation
- Ownership and drive of results by all involved
- Use of facilitators, internal or external to the organisation
- The right focus on monetary benefits when prioritizing improvements
- The speed of implementation, for example improvements spread over 2-9 months or 'blitz' improvements spread over 1-3 weeks
- The extent of focus on 'hard' and 'soft' tools
- The extent of integration of improvement within overall business strategy and operation

It is most likely that there is no 'one right universal way' to implement Lean / Six Sigma. Even the same organisation will have to keep flexibility in Lean /Six Sigma deployment to achieve desired goals.

10.2.3 Methods, tools and techniques

Those are specific Lean / Six Sigma tools, whether widely recognized or 'in-house' developed or adapted.

Successful Lean / Six Sigma implementation requires the right mind-set, effective implementation strategies and effective and efficient use of improvement tools. The author strongly believes that no failure can be caused by Lean / Six Sigma improvement methods, tools and techniques themselves, but rather by ineffective improvement strategies and/or inappropriate mind-set.

Successful improvement is not only caused by improvement tools

Too many times failures is attributed against Lean / Six Sigma methods, as their application is more visible than applied mind-set and implementation strategies.

10.3 Experiential Improvement Model – A Case Study

The following case study presents specific improvement strategies that were ‘hands-on’ developed and used by the author during his facilitation of definition, implementation and sustaining improvement of complete value stream within an engineering and manufacturing organisation. At the beginning of their improvement journey, the organisation was organised in a traditional way, as follows:

- Departmentalized, business functions acted in isolation rather than in unison
- Production system was running in batches, through push system, all the way from Sales to Manufacturing
- Formal and structured business improvement was in its infancy

The management wanted to focus improvement activities on fully understood customer, market and business improvement needs, re-align organisation from traditionally (functionally) structured to value stream organisation and get all functions to work together to create and sustain the new system.

10.3.1 Direction - Defining Improvement Needs

This step was crucial as it sets improvement direction. Successful definition of improvement needs determines how effective improvement is going to be. The author facilitated plant management team in a one day workshop. Customer and business improvement needs were categorized against Quality – Delivery – Cost/Price. *Quality-Delivery-Cost/Price categories are applicable to any organisation, regardless of industry type, size and ownership. In order to compete on the market suppliers need to satisfy minimum requirements for Quality, Delivery and Price, but just meeting the minimum will not necessarily make their product more competitive. They need to achieve a ‘competitive advantage’ - a product or service feature(s) that make customers choose specific supplier.*

Improvement team had a structured discussion, aiming to identify specific market competitive advantages. At the end ‘Delivery’ was identified as having the biggest room for improvement and highest impact on the organisation competitive position. The objective was simply defined as: *“We need to reduce overall lead time, from taking an order to delivery and cash collection.”*

Benchmarking against competitors and market needs revealed that there was a gap between current company performance and its main competitors, and that reduced lead time would secure bigger market share. Targets were set based on this benchmarking, i.e. looking into delivery (lead) time from customers point of view. Extra attention was paid to quality of information and results were presented using simple charting techniques, for example bar charts as presented in figure 10.2.

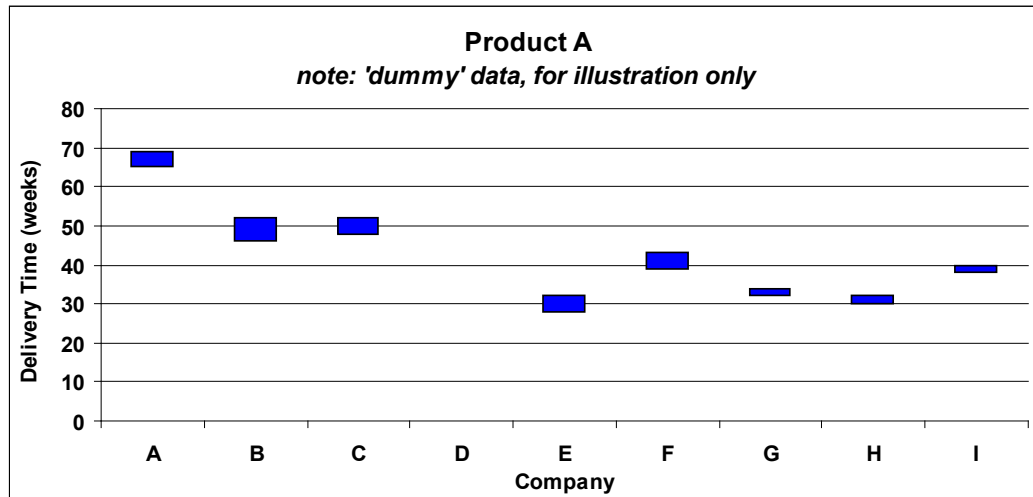

Figure 10.2: Lead Time Benchmark ('dummy' data, for illustration only)

Benchmarking exercise helped the team to faster define and agree improvement directions and goals.

10.3.2 Vision and Ownership

Each team member accepted need to reduce overall lead time, from taking an order to delivery and cash collection. The next step was to build a vision – to visualize overall flow of information and material that will deliver reduced significantly lead time. After brief discussion the proposal was a simple vision statement: “End-to-end flow running just-in-time”, meaning that no work and job would ever be stopped and waiting. Such work flow, by default, takes shortest lead time.

The goal was defined as “*End-To-End Just-In-Time 'Product A' Stream by end of ###*”. We wrote in the middle of a whiteboard our Vision Statement as: “*End-to-end JIT 'A' Stream' by and of ###*”. ‘End-To-End’ means that we wanted to always consider complete product ‘A’ stream, from tendering to delivery and cash collection. This focus and continuous view of the complete stream enabled better prioritization of improvements and prevented sub-optimisation of product ‘A’ stream. After agreeing and sharing the vision and the ultimate goal, each team member was asked the following question: “*Do you really believe in this vision?*”

All of them answered ‘Yes’ and each member of the team put their signature next to the Vision Statement on the whiteboard. In this way, each team member has demonstrated the ownership of the common goal and timescale.

10.3.3 Improvement Plan

The next step was to develop elements of our *End-to-end JIT 'A' Stream* vision. We started by brainstorming how each of us can visualize ideal flow of information and material, end-to-end, starting from tendering, through sales, engineering, supply chain, manufacturing... to product and service delivery and cash collection.

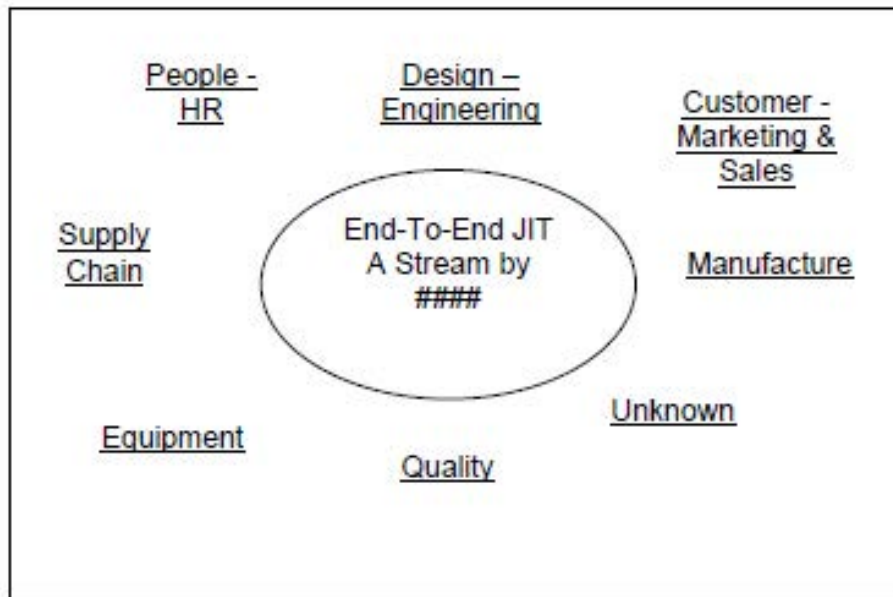

Figure 10.3: Vision Statement and Vision Elements (some elements presented as example)

As discussed, we kept capturing elements of our vision, writing them around the Vision Statement. The final outcome was similar to that depicted in figure 10.3- Vision Statement in the middle and vision elements around. The vision key elements that were initially identified were as follows:

- Key Performance Indicators
- Design
- People
- Maintenance
- Planning
- Supply Chain
- Work-In-Progress Reduction
- Quality
- Cell / production
- Machine / Equipment
- Customer
- Benchmarking
- IT
- Unknown

We deliberately added element 'Unknown' to leave room for improvement and keep our mind open to future ideas. The next step was to allocate leaders against each Vision Element. We simply asked ourselves: *"Who has required mind set, knowledge, skills, experience and position to lead a particular Vision Element?"* Names were allocated within 5 minutes, as most people volunteered to lead their function or department, for example 'People – HR' was led by HR manager, 'Maintenance' by Maintenance manager, and so on.

In total, 13 leaders were nominated. For 'Unknown' we decided to complete end-to-end Value Stream Analysis to identify and prioritise improvement opportunities in existing and new Vision Elements. Allocated leader of 'Unknown' was plant Lean Facilitator, who was fully trained and experienced in preparing and running Value Stream Analysis. All nominated leaders accepted their roles and full ownership and responsibility.

Within first 3 months a couple of leaders gave up and asked to be replaced. The follow up process, which is to be presented in the next chapter, made it very visible who was delivering agreed objectives and who struggled. A peer pressure and regular demand for results made those two leaders to ask to be replaced. No individual or the team suffered, ex-leaders continued to support the overall improvement project and new leaders.

10.3.4 Sustain

In order to have visibility of the progress the team produced a simple matrix, which was named ‘Tracker’, as presented in the figure 10.4. Progress tracker had the following elements:

A – Vision Statement

B – Vision Element, Responsible department / function, Leader’s name

C – Status at the beginning of the improvement, which is qualitative and/or quantitative statement of the situation; for example: ‘no visual management present in the cell’

– Agreed milestones, consisting of qualitative and quantitative outcome statements and target dates, for example ‘visual management will be defined and half of it implemented in the cell by 30-Jun

D – Monthly team review, which consisted of:

- colour coded field (green/yellow/red) against expected progress

- statement of achievements and

- specific actions, if required to rectify ‘yellow’/‘red’ to ‘green’ or any other planned improvement action to be completed and reported at the next monthly review

Date	"A" Product JIT end-to-end Value Stream Improvement										Progress: major concern minor concern OK			
Stream Element	Visual Mgmt	KPIs	Design	People	Mainten'ce	Planning	Supply Chain	WIP Reduction	Quality	Cell	Machine	Customer	Benchmarking	IT
Process / Area	B	Cell	Engineering	HR	Mnfg	Prod. Control	Purch'g	Prod. Control	QA	Cell	Cell	Sales	Lean	IT
Leader														
Status on 01-March Where are we today?														
Goal by 30-Jun Where do we need to be?	C													
Goal by 31-Dec Where do we need to be?														
Goal by 30-Jun Where do we need to be?														
What are we going to do to get there? Progress Reviews														
Review 24-April														
Review 22-May														
Review 19-Jun														
Review 26-July														
Review 27-Sep														
Review 26-Oct	D													
Review 22-Nov														
Review 19-Dec														
Review 31-Jan														

Figure 10.4: Progress Tracker

Reviews were conducted with the presence of all team members present or their substitutes when they were not available. Each team member had 5 minutes to present expected achievement of their Vision Element, report on actions completion, raise relevant concerns and propose how they are to overcome them, and finally, to colour code their own Vision Element monthly progress, as appropriate. Those meetings proved to be excellent way of communication, as all team members were at least once a month updated on progress of end-to-end value stream improvement.

The author's main objectives, as a facilitator of the overall improvement process, were to instil ownership of each Vision Element with its leader and more importantly to get each team member to realize and continuously act from 'end-to-end' mind-set point of view. In other words: *To act locally and think globally*- where 'locally' stands for is their own Vision Element (which is also the value stream element) and 'globally' stands for complete 'end-to-end' value stream. All actions were completed using relevant Lean Thinking and Statistical Thinking method and tools.

It is more important to get people to believe in why they need to do something rather than to train them in how to do it. People who truly believe in shared vision and are actively helped by their management will make Vision happen. In the author's experience, most Lean / Six Sigma trainings aim to teach people HOWs of Lean / Six Sigma. It makes bigger impact on a mind-set and will more likely get people to change their practice and behaviour when Lean / Six Sigma training demonstrates WHYs of Lean / Six Sigma.

10.3.5 Summary of Achieved Benefits

In general, improvement benefits can be split into the following three categories:

- Observable benefits, for example behaviour, attitude, housekeeping, morale, ...
- Operational benefits, for example utilized space reduction, lead time reduction, quality improvement...and
- Monetary benefits, for example direct labour utilization, overhead recovery increase, supply chain cost, work in progress, cash flow, cost of human resources, cost of poor quality...

The following is the summary of operational benefits achieved in improvement project presented in this paper.

Improvement Objective	Target	Achieved / Comment
Improve productivity	by 50%	100%
Reduce average lead time	by 50%	75%
Reduce work-in-progress	by 40%	33% - initial improvement
Reduce space	by 40%	73%
Reduce waste (transport...)	by 60%	67%
Develop people	-	11 people involved & trained
Improve On-Time-Delivery	> 90%	86%

10.4 Conclusion

Presented model is an experiential model - the outcome of a number of actual applications where significant improvements have been achieved, an example is presented in the previous paragraph. The main purpose of this model is to provide an improvement team and their leader with a method to:

- define and share improvement vision, derived from customers/market and business needs
- effectively and simply break down vision statement into actionable process/functional elements, including ownership, roles and responsibilities of each team member
- efficient way to define objectives, milestones and maintain regular review of the progress against each vision element

This model is very simple, logical and structured improvement system that integrates all three elements of a success:

- mind-set - where team leader and facilitator clearly articulate and continuously coach the right way of thinking, demonstrate the right behaviour and policies
- implementation strategy – ‘a recipe’ that helps an improvement team to share and make the right vision happen fast
- relevant Lean/Six Sigma method/tools – the right improvement tools are used to complete agreed tasks and deliver and sustain agreed improvement objectives

The key strengths and limitations of the model are presented in table 10.1 below.

Strengths	Limitations
Simple and universally applicable - for any improvement, across any private, public organisation and also in private life.	Good outcomes require true understanding of customer, market and business needs. The model itself will not necessarily correct wrong vision.
Based on systems thinking – the model seeks inclusion of all the elements of the system that make impact on delivery of the vision statement. This promotes cross-functional and value stream systems and thinking.	Team leader and/or facilitator must have the right mind-set from the very beginning – clear understanding of system, value stream and team work to lead. Effectiveness and efficiency of the model depends on their mind-set and leadership skills.
Driven by customer, market and business needs – full understanding of those needs is the starting point	Ineffectiveness caused by focusing on internal issues, improvement actions, neglecting the customer. The model assumes true understanding of customer needs.
Achievement focus – improvement activities are defined and driven by defined vision statement and objectives, as derived from understanding true customer, market and business needs.	As above – the model itself will not necessarily correct wrong vision statement and ultimate goal, i.e. the effectiveness of the model is not implicitly embedded.
Teamwork - supports teamwork with clear individual objectives, roles and responsibilities. Peer pressure can be used to resolve individuals that are not willing to play their roles.	Requires strong leadership to resolve individuals who are not willing to participate, peer pressure can help.
Structured progress review – regular review of progress against agreed milestones	
'Hands-on' training – experienced facilitator(s) can develop team members through 'learning by doing.'	Facilitator(s) who have good experience and knowledge of business improvement tools, e.g. Lean/Six Sigma are required to develop team members.
Milestones and metrics – clearly defined and shared from the beginning, progress regularly reviewed and status of all actions tangibly expressed in either numerical or descriptive form	Selection of wrong metrics and milestones can lead actions into wrong direction and/or discourage team

Table 10.1: Strengths and weaknesses of the model

The author would recommend 'pull system' when selecting which improvement tools to use, where those tools are defined by shared improvement vision, agreed improvement objectives and team roles & responsibilities. The author also believes that the next logical step that complements Lean/Six Sigma is adaptation of relevant and practical elements of modern psychology and linguistic practice that can effectively and efficiently help embed Lean/Six Sigma way of thinking in order to create work systems that achieve and sustain desired business improvement objectives.

10.5 References

Clark, J 2008, How To Achieve Fast Change Using Advanced Elements of Linguistic, Coaching and Psychology - Live Experiential Training Event, Glasgow, UK

Harrison, A 2008, Do It Now, Do It Right and Sustain, presentation at the 9th Annual Process Excellence Summit, London

Harrison, A 1994, Six Sigma Training and Certification by Dr Mikel J. Harry private notes

Harry, M 1994, *The Vision of Six Sigma – A Roadmap for Breakthrough*, Sigma Publishing Company, Phoenix Arizona, USA

Imai, M 1986, *Kaizen*, McGraw-Hill, New York, ISBN-10: 007554332X

Imai, M 1997, *Gemba Kaizen: A Commonsense, Low-Cost Approach to Management: A Commonsense, Low-cost Approach to Management*, McGraw-Hill Professional, ISBN-10: 0070314462

11 Enhancing the Six Sigma Problem-Solving Methodology Using the Soft Systems Methodology

Alex Douglas, Sandra Middleton

Liverpool Business School, John Moores University

98 Mount Pleasant, Liverpool

Email: a.douglas@ljmu.ac.uk; s.m.middleton@ljmu.ac.uk

Jiju Antony

Department of Design Manufacture and Engineering Management

Strathclyde Institute of Operations Management

University of Strathclyde

Glasgow, United Kingdom

Email: jiju.antony@strath.ac.uk

Abstract

This theoretical paper describes the two main approaches to problem-solving – the reductionist approach and the systemic approach. The reductionist approach, the dominant problem solving approach, works well for simple, well defined “hard” problems but fails to perform well on complex, ill-defined “soft” problems and when the parts of a more complex problem are all independently optimised. The holistic approach aims to understand problems holistically and addresses many of the weaknesses of the reductionist approach. This paper identifies evidence to categorise Six Sigma as a reductionist approach to problem-solving. Six Sigma therefore must be open to improvement opportunities particularly if they can address the weaknesses inherent in the reductionist approach. This requires a more holistic approach such as that offered by Soft Systems Methodology. The extant literature is reviewed to evaluate SSM to determine if it could broaden the DMAIC approach making it more effective and applicable to both simple and complex problem situations

Key Words: Six Sigma, Soft Systems Methodology, Problem-solving, Reductionism, Holism.

11.1 Introduction

If there is any doubt about the spectacular rise of Six Sigma one has only to witness the very large number of articles now available on that topic in academic search engines such as Business Source Premier and the year-on-year exponential increase in such articles (Goetze and Offidde 2005). But Six Sigma today represents a number of differing concepts and is not without criticism from both practitioners and academics. Six Sigma has been variously describes as:

- a) A performance measurement (Black and Revere 2006, Gygi et al 2005);
- b) A problem-solving methodology (Gygi et al 2005, McAdam et al 2005, Hilds & Sanders 2007);
- c) A quality movement developed from Total Quality Management (TQM) (McAdam et al 2005, Spencer 1994, Black and Revere 2005)

This paper is concerned with Six Sigma as a problem-solving methodology. However, it is not the only approach to problem-solving. The main aims of this paper are:

- (i) To compare and contrast the reductionist and holistic approaches to problem-solving, categorising Six Sigma as either the former or the latter;
- (ii) Evaluate the Soft Systems Methodology to determine whether it could make an appropriate contribution to the Six Sigma toolkit.

11.2 Criticisms of Six Sigma

A large amount of the extant literature on Six Sigma focuses on its successes and in particular the financial benefits that are deemed to be the return on investment made by organisations deploying the technique (See for example Hahn et al.1999, Raisinghani et al. 2005, Sörqvist, 2001). Six Sigma, however, is not without its critics and a number of criticisms have been reported and discussed (Truscott 2003, Stephens 2001, Cooper & Noonan 2003, Senapati 2004, Bendell 2004, Dahlgaard & Dahlgaard 2006, Edgeman & Bigio 2004, Antony & Coronado 2002, Bajari 2001, Schneiderman 1999, Goh 2002, Antony 2004). However, the most relevant criticisms appropriate to this paper are:

- Managing change is a major issue. Hopen (2003) discusses managing resistance to change as more complex than using the Six Sigma tool kit and is usually where Six Sigma projects fail. In order to change the process the organisation culture may first have to be changed (Chauncey & Thornton, 2006);
- Edgeman & Bigio (2004) suggest a future improvement for Six Sigma is to adopt and adapt ideas from other fields in order to advance and strengthen the Six Sigma approach. Indeed, since everything is in a state of change, Watson (2007) asks the question “Should Six Sigma change to embrace change?”

- There is much debate in the extant literature regarding the relationship between Six Sigma and Total Quality Management (see for example McAdam et al. 2005, Black & Revere, 2006). This debate is beyond the scope of this paper, however, as Senapati (2004) states TQM's greatest merit is its approach to tackling the soft issues of the problem-solving process. It is these issues that are problematic for Six Sigma.

This paper takes the view that in order to survive Six Sigma must evolve as the business environment evolves and so tackle some of the criticisms discussed above.

11.3 Problem-Solving

There are two approaches to problem-solving. The conventional problem-solving approach, used by most organisations, is based on reductionism (Nadler 2004). The other approach is based on holism. The differences are discussed below.

11.3.1 The Reductionist / Mechanistic / "Hard" Approach

The reductionist approach is a mechanistic or "hard" systems approach to problem-solving that derives from the Cartesian scientific thinking paradigm that emerged in 17th Century Europe named after the French philosopher Descartes. His approach relied on empirical evidence, logic and reason. Problems are solved scientifically using the following steps (Nadler, 2004):

- Identify a key part or assumption;
- Collect data about the part;
- Analyse the data;
- Propose a hypothesis;
- Test the hypothesis;
- Evaluate the results;
- Make a conclusion

This is the dominant problem solving approach and is based on four principles (Nadler, 2004):

- 1) Everything can be divided into its component parts;
- 2) Any of these parts can be replaced;
- 3) The solution of the partial problem can solve the entire problem;
- 4) The whole is nothing more than the sum of its parts

When these principles were applied to organisations, i.e. an entity made up of parts each of which could be independently optimised in pursuit of the same objective, they failed to perform well as a whole. The need for Systems Thinking and the interdependence of the parts was established. The reductionist approach was more effective if problems were simple, “hard” and well structured / defined. That is they have completely specified initial conditions, goals and operators. Furthermore, the hard systems approach asserts that all things can be measured and therefore can be analysed using standard quantitative tools and techniques. The reductionist approach also adopts a means-ends strategy to problem solving by attempting to reduce the gap between the goal state and the problem state (Sweller et al. 1982). Hard Systems methodologies all utilise the Means to an End approach.

Jackson (1987) identified the main problems of this approach as its inability to cope with multiple perceptions of reality and handle extreme complexity. Flood (1995) argued that “Reductionism dominates management thinking and organisational problem solving” and leads to “ineffective problem solving”. This is because it tackles only pieces of the problem without considering the consequences of any changes on the whole problem and whole organisation (Flood 1995, Nadler 2004).

11.3.2 The Holistic / Systemic / "Soft" Approach

Holism is the opposite of reductionism and is based on the idea that all the properties of a given system cannot be explained by its fundamental parts. The principle of holism was concisely captured by Aristotle when he described it as "the whole is more than the sum of the parts". Healey (2004) refers to "*Methodological Holism*: An understanding of a certain kind of complex system is best sought at the level of principles governing the behavior of the whole system, and not at the level of the structure and behavior of its component parts." He then goes on to argue that it is possible to view holism from a metaphysical perspective where the nature of some "wholes" cannot be derived from an examination from their parts. This approach works best with ill-structured / defined problems that have some aspects which are not completely specified.

The Six Sigma DMAIC methodology (Define, Measure, Analyse, Improve and Control) utilises the sub-optimisation principle; if each element of the problem is optimised independently it does not mean that the system as a whole will operate efficiently. DMAIC is similar to the Descartes methodology described above. Clearly it identifies the desired end (goal) at the start of the project and the remaining methodology is identifying the means of achieving this desired state. Statistically the desired performance goal is for a process to produce fewer than 3.4 defects (or errors) per million opportunities for defects (Gygi et al, 2005). Many of the quality tools used within Six Sigma are dependent upon reductionism (David, 2003). Where some of the characteristics of problem situations are selected and minimised some of the important elements may be lost. Six Sigma can be viewed as a reductionist / "hard" system approach. Indeed it has been called "the ultimate reductionist approach" (www.healthcareisixsigma.com) and as such may lack certain components that could improve its performance, particularly those associated with "softer" issues such as people and where standard quantitative tools are not able to measure and analyse performance issues. Clearly Six Sigma is open to improvement. The next section examines possible sources of these improvement components from within one "Soft" / Holistic approach, namely the Soft Systems Methodology.

11.4 Soft Systems Methodology

Checkland developed the Soft Systems Methodology (SSM) for use in ill-structured or "messy" problem situations and to identify acceptable improvements that could be made to these situations (Checkland and Scholes 1990, Flood and Jackson 1991). These situations occur when the root of the problem or even the nature of the problem itself is unclear or unknown. It is further argued that SSM is best employed where the interests of the parties or stakeholders are compatible but the participants have developed their value sets and beliefs along different paths but nonetheless are ready to accommodate and compromise, if possible. The methodology aims to guide actions in trying to "manage" real world problem situations. "Soft" or unstructured problems are those in which a modelling language is required which is capable of a more detailed, "richer" description of the real world than mathematics and statistics can provide. Such a language is based upon the concept of a Human Activity System (HAS) (Wilson 1990). A HAS is defined as "a collection of activities, in which people are purposefully engaged, and the relationship between the activities" (Platt and Warwick, 1995). The methodology identifies a wide range of stakeholders' views and uses tools to study the problems in that Human Activity System (HAS) as discussed in Beckford (1998). Figure 11.1 below shows the Four-Activities model of SSM, as it is presented in Checkland and Scholes (1990).

The tools of SSM provide an alternative approach to identifying the issue or issues which are causing the problem. The main tool is the “Rich Picture”, as the name suggests it is a pictorial representation of the problem (Stage 1), identifying stakeholders, issues which cause conflict and the primary tasks of the system. The picture has no particular hierarchy or structure but simply records all the elements of the system and the issues around it as they become apparent, no priority or status is accorded to any particular issue or primary task. It gives a holistic, multi-perspective view of the situation methods.

The rich picture is used to produce alternative scenarios through the deriving of a set of relevant purposeful activity models each based on a declared world-view (Stage 2). Stage 2 encourages the development of alternative systems and thus the exploration of alternative scenarios. Stage 3 is debating the situation, using the models. The outcome of the debate should be (a) the changes that are desirable and culturally feasible, and (b) finding accommodations between conflicting interests which will allow actions-to-improve to be taken (Stage 4) (Checkland and Scholes 1999).

11.5 Conclusions

Six Sigma has clearly delivered substantial savings for many organisations. However, because of its reductionist approach it may not be maximising its potential, particularly where problems are ill-structured and complex where a more holistic approach is required. The purpose of SSM is to deal with complex and messy problem situations and especially the human elements of the problem. It is recognised by most business analysts that the majority of business system developments and enhancements include just these issues and thus this weakness does appear to compromise the success of Six Sigma in solving or improving problem situations where human actions or problem identification are issues. In particular the DMAIC approach may benefit from the use of such SSM tools as the Rich Picture for a more holistic view of the problem, its stakeholders and context. This can then lead to the identification of all relevant human activities and their people issues that impact on the project selected for improvement. The engagement of the relevant people in the problem-solving process and the accommodation of any potential conflicts of interest as well as any cultural issues may reduce resistance to change and improve the success rate of six sigma projects. It is recognised that Six Sigma practitioners may find some SSM tools more beneficial than others, at least in the first instance, as they are being asked to take a less “hard” perspective than formerly. Future papers will evaluate other Systems Thinking tools to determine what contribution, if any, they can make to the Six Sigma DMAIC problem-solving methodology.

11.6 References

- Antony, J., 2004, ‘Some Pros and Cons of Six Sigma: An Academic Perspective’, *The TQM Magazine*, vol. 16, no. 4, pp. 303-306.
- Antony, J., & Coronado, R 2002, ‘Critical Success Factors for the Successful Implementation of Six Sigma Projects in Organisations’, *The TQM Magazine*, vol. 14, no. 2, pp. 92-99.
- Bajaria, HJ 2001, Six Sigma Quality: Popular Notion Versus Strategic Notion, *Proceedings of the 4th International QMOD Conference*, LinkÖpings University, Sweden, pp. 136-143.
- Beckford, J 1998, *Quality: A Critical Introduction*, Routledge, New York.

- Bendell, T 2004, 'A Review and Comparison of Six Sigma and the Lean Organisation', *proceedings of the 7th International Conference on Quality Management and Organisational Development QMOD*, Monterrey Institute of Technology, Mexico, pp. 39-56.
- Black, K., & Revere, L 2006, 'Six Sigma Arises from the Ashes of TQM with a Twist', *International Journal of Health Care Quality Assurance*, vol. 19, no.3, pp. 259-266.
- Chauncey, D., & Thornton, G 2006, 'Soft Solution to a Hard Problem', *Six Sigma Forum Magazine*, vol. 6, no.1, pp.24-28.
- Checkland, P., & Scholes, J 1990, *Soft Systems Methodology in Action*, Wiley, Chichester.
- Checkland, P., & Scholes, J 1999, *Soft Systems Methodology in Action up-dated*, Wiley, Chichester.
- Cooper, NP., & Noonan, P 2003, 'Do Teams And Six Sigma Go Together?', *Quality Progress*, June, pp. 25-28.
- Dahlgaard, JJ., & Dahlgaard-Park, Su Mi, 2006, 'Lean Production, Six Sigma Quality and Company Culture', *The TQM Magazine*, vol. 18, no. 3, pp. 263-281.
- David, S 2003, Skymarks Quotations Database, available at www.skymark.com/resources/notes.asp accessed 24.04.2006.
- Edgeman, RL., & Bigio, DI (2004), 'Six Sigma in Metaphor: Heresy or Holy Writ', *Quality Progress*, January, pp. 25-30.
- Flood, RL 1995, *Solving Problem Solving*, Wiley, New York.
- Flood, RL., & Jackson, MC 1991, *Creative Problem Solving: Total Systems Intervention*, Wiley, New York.
- Goeke, RJ., & Offodile, OF 2005, 'Forecasting Management Philosophy Life Cycles: A Comparative Study of Six Sigma and TQM', *Quality Management Journal*, vol. 12, no. 2, pp. 34-46.
- Goh, TN 2002, 'A Strategic Assessment of Six Sigma', *Quality and Reliability Engineering International*, vol.18, no.2, pp. 403-410.
- Goh, TN., & Xie, M 2004, 'Improving on the Six Sigma Paradigm', *The TQM Magazine*, vol.16, no.4, pp. 235-240.
- Gygi, C., DeCarlo, N., & Williams, B 2005, *Six Sigma For Dummies*, Wiley Publishing, Hoboken, NJ.
- Hahn, G., Hill, W., Hoerl, R., & Zinkgraf, S 1999, 'The Impact of Six Sigma – A Glimpse into the Future of Statistics', *The American Statistician*, vol. 53, no. 3., pp. 208-215.
- Healey, R 2004, *Holism and Nonseparability in Physics*, in Edward N. Zalta (Ed.), *The Stanford Encyclopedia of Philosophy* (Winter 2004 Edition), available at <http://plato.stanford.edu/archives/win2004/entries/physics-holism/> Accessed. 12.05.2006.

- Hilds, C., & Sanders, D 2007, 'Transcational Six Sigma: Is IT Really Different?', *Six Sigma Forum Magazine*, vol. 7, no.1, pp. 37-39.
- Hopen, D 2003, 'The Softer Side of Six Sigma', *Six Sigma Forum Magazine*, vol. 2, no. 2, pp.8.
- Jackson, MC 1987, 'Present Positions and Future Prospects in Management Science', *Omega*, vol. 15, no. 6, pp. 455-466.
- McAdam, R., Hazlett, S-A., & Henderson, J 2005, 'A Critical Review of Six Sigma: Exploring the Dichotomies', *The International Journal of Organisational Analysis*, vol. 13, no.2, pp. 151-174.
- Nadler, G 2004, 'Taking a Holistic Path', *Industrial Management*, vol. 46, no.6, pp.26-31.
- Platt, A., & Warwick, S 1995, 'Review of Soft Systems Methodology', *Industrial Management and Data Systems*, vol.95, no.4, pp.19-21.
- Raisinghani, MS., Ette, H., Pierce, R., Cannon, G., & Daripaly, P 2005, 'Six Sigma: Concepts, Tools, and Applications', *Industrial Management and Data Systems*, vol. 105, no.4, pp. 491-505.
- Schneiderman, AW 1999, Question: When is Six Sigma Not Six Sigma? Answer: When it's the Six Sigma metric!! Available at www.schneiderman.com accessed 12/06/2008.
- Senapati, NR 2004, 'Six Sigma: Myths and Realities', *International Journal of Quality and Reliability Management*, vol. 21, no. 6, pp. 683-690.
- Sörqvist, L 2001, 'Six Sigma the Swedish Way', *Proceedings of the 4th International Quality Management and Organisational Development (QMOD) Conference*, LinkÖpings University, Sweden, pp.144-150.
- Spencer, BA 1994, 'Models of Organisation and Total Quality Management: A Comparison and Critical Evaluation', *Academy of Management Review*, vol. 19, no.3, pp. 446-471.
- Stamatis, DH 2000, 'Who Needs Six Sigma, Anyway?', *Quality Digest*, available online at www.qualitydigest.com/may00/html/sixsigmacon.html accessed on 12/06/2008.
- Stephens, K 2001, 'What is the Future for Six Sigma', *Six Sigma Forum Magazine*, vol.1, no.1, pp.47.
- Sweller, J., Mawer, RF., & Howe, W 1982, 'Consequences of History-Cued and Means-Ends Strategies in Problem Solving', *American Journal of Psychology*, vol.95, no.3, pp. 455-483.
- Truscott, B 2003, 'Six Sigma: Love or Hate', *Quality World*, pp. 14-17.

Watson, GH 2007, 'Change Management: How Important Is It For Six Sigma', *Six Sigma Forum Magazine*, vol. 6, no.4, pp.39-40.

Wilson, B 1990, *Systems: Concepts, Methodologies and Applications*, John Wiley and Sons, New York.

www.healthcareisixsigma.com UVA Reduces Coding Errors with Six Sigma, accessed 24/07/2008.

12 The Integration of Six Sigma and Green Supply Chain Management

Xixi Fan* and Alessandro Brun

Department of Management, Economics and Industrial Engineering

Politecnico di Milano

Via G.Colombo, 40, 20133, Milan, Italy

E-Mail: xixi.fan@mail.polimi.it , alessandro.brun@polimi.it

Abstract

The application of Six Sigma has been the focus of recent study. Introducing Six Sigma into Green Supply Chain management is proposed in the paper by describing what organizations practicing Green Supply Chain Management can gain from Six Sigma and what Six Sigma practitioners can benefit on exploring Green Supply Chain Management. A concerted implementation of the practices will lead to environment-oriented quality management, overcoming the limitations of each practice when adopted in isolation. Possible approaches to integrating the two methodologies are presented for further research. Exploration of the integration further digs into the value of the two methods and suggestions are provided in terms of methods that would create a Green Six Sigma company. The paper puts forward value propositions of methodology integration, but there is lack of a comprehensive description of phenomenon to support the practice. It will be addressed in future research.

Key words: Quality Management, Six Sigma, Green Supply Chain Management

12.1 Introduction

The concept of quality evolves over time, and so does quality management. As early as the Middle Ages in Europe it was managed by informal inspection, as the manufacturing and quality inspection activities are tied together in the hand of the craftsman. In 1923, W.A.Shewhart developed a statistical chart for the control of product variables, which marked the conception of statistical quality control. From 1950s and 1960s, quality began to evolve from a manufacturing-based discipline to one with managerial perspective (Yong and Wilkinson 2002). Quality assurance shifted the focus to preventing defects, where the supplier's focus is on telling the good from the bad parts. Then total quality management came into being in Japan after World War Two and went west, becoming a widespread concept for quality management. Since 1980s, Six Sigma, as a western methodology, has started to prevail all over the world. The study on Six Sigma still keeps going on and going wide and deep.

On the other hand, environmental issues have drawn the attention of researchers. Manufacturing organizations also have recognized the importance of their supply chain partners in the management of the natural environment. Major manufacturers around the world have developed and implemented comprehensive programs to control and improve their environmental practices across the entire supply chain (Krut & Karasin 1999). Louis Vuitton has launched eco-luxury program along its supply chain for the purpose of creating ethic value to the brand and appealing to customers' requirements. The term "Green Supply Chain" is coined to describe this phenomenon.

As we bring up this two research areas, a possible integration of them is the research focus which we are going to target at. Green Supply Chain Management (GSCM) is burgeoning and it is in need of effective methodologies to secure its steady growth. The current techniques applied in GSCM are not sufficiently address some specific issues, while Six Sigma, which is a comparatively well-established method, could make contributions to generate a novel viewpoint and provide reformative tools and techniques in GSCM. The application of Six Sigma into GSCM is also extending the methodology to a broad area and exploring it benefits in a larger degree.

The purpose of this paper is to identify the research opportunities regarding Six Sigma and GSCM by describing the two approaches and main concepts and techniques that underline their implementation. The discussion will be followed by an analysis of how Six Sigma and GSCM can be integrated. Green Six Sigma bridges these two practices via evolutionary, rather than revolutionary, changes. The cases are briefly presented to demonstrate how Green Six Sigma is arising in practice. Finally, the further research focus is presented.

12.2 Six Sigma

Sigma σ is the letter used in statistical model to signify the standard deviation from the mean. Six Sigma, in mathematical and statistical terms, is six standard deviation units of process variation. From the quality management perspective, it could be seen as a quality target of 99.9997% of production conforming to specifications. If the manufacturer produces 1,000,000 units of components, at maximum 3 of them would be regarded as defects. Nevertheless, the scope of Six Sigma is far beyond the statistical meaning, and is extended to a quality program which was initiated by Motorola in 1986 when Bill Smith proposed to insert statistics into the philosophy of TQM, and propagandized by GE's overwhelming success. Since then, Six Sigma evolved from a quality metric to a comprehensive methodology to achieve unprecedented quality levels by "focusing on characteristics that are critical to customers and identifying and eliminating causes of errors or defects in process" (Evans and Lindsay 2005).

Six Sigma borrows some ideas from TQM, but also differentiates itself from TQM in several aspects which compose the essentials of Six Sigma (Basu and Wright 2005).

- Six Sigma emphasizes statistical control and measurement. Apart from the tools advocated in TQM, including control charts, histograms, check sheets, scatter plots, cause-and-effect diagrams, flowcharts, and Pareto charts (Arnheiter and Maleyeff 2005), Six Sigma also employs Design of Experiments, Failure Mode and Effects Analysis, Quality Control and Capability Analysis (Raisinghani 2005).
- It adopts structured training programs at different level (Champion, Master Black Belt, Black Belt and Green Belt).
- It is a project-based approach exploiting a set of problem-solving techniques. Projects are carried out following the DMAIC approach. DMAIC stands for Define, Measure, Analyze, Improve and Control.
- It quantifies the benefits in tangible savings and focus on improvement with financial accountability.
- It requires top management commitment and leadership, continuous education and annual saving plan.

12.3 Green Supply Chain Management

Lately, environmental sustainability in the supply chain has been the topic of several papers (Hall 2000, Bowen et al. 2001). Vachon and Klassen (2006) put forward the concept of green supply chain practices which comprise two sets of related yet independent environmental activities: environmental collaboration and environmental monitoring. Hence, an organization's green supply chain practices imply: internalizing by integrating its environmental management activities with other organizations in the supply chain or externalizing environmental management in the supply chain by employing market-based mechanisms.

Since GSCM considers environmental issues at every aspect of supply chain, Srivastava (2007) specifies the five areas covered by GSCM: product design, material sourcing and selection, manufacturing, distribution and product end-of-life management. Design for Environment as a method comes into being and is understood to be: "a systematic process by which firms design products and processes in an environmentally conscious way" (Lenox et al., 1996). In terms of material sourcing and selection, Green Purchasing arises to address relevant issues (Min and Galle 1997). Clean production, reverse logistics, waste management are all in place to settle the environmental problems with production, distribution and product end-of-life (Srivastava 2007).

Five practices are employed to address environmentally conscious business, which include reduce, reuse, remanufacture, recycle, and disposal alternatives (Sarkis 2003). Sarkis (2003) suggested that reduction could be aided by total quality management and JIT programs which aim at eliminating waste and also the redesigning of product and process will benefit the reduction of waste or toxic emission. End-of-life management entails the remaining four factors.

12.4 Potential research areas of Six Sigma and Green Supply Chain Management

12.4.1 Research gap in Six Sigma

Six Sigma is one of the methods successfully employed in Quality Management. Its contribution has been proven by the enormous savings obtained by practicing companies. Nevertheless, Six Sigma can be further explored to extend its advantages, and for the purpose of this paper prospective research could focus on the following areas.

- Six Sigma is mainly applied by companies internally, but the concept of quality in Six Sigma can be expanded outside the manufacturing. It relates to the entire customer value, encompassing manufacturing, delivery, after service. Also Six Sigma is not only devoted to quality improvement, its techniques and methodology can be extended to customer interaction, supplier involvement. How to exploit Six Sigma on other aspects of management is untouched area in academic research.
- Stamatis (2000) states that Six Sigma is “an appraisal tool that does nothing for presentation”. This argument indicates that quality needs to be integrated into design, not just to be monitored in the process of manufacturing. Six Sigma has not contributed enough to plan quality ahead of the manufacturing. How Six Sigma can impact product design is open to research to further explore its value.

12.4.2 Research gap in Green Supply Chain Management

GSCM is still in its infancy, compared to other mature fields such as quality management. A large number of potential research subjects exist in the study. Srivastava (2007) conducted a comprehensive state-of-the-art literature review on GSCM, and concluded that the complexity of environmental issues pose challenges to researchers and suggested that research is demanded in deciding how companies select products to maximize returns. For the purpose of this paper, three relevant research gaps are pinpointed and analyzed.

- First of all, there is a poor selection of effective and practical tools in GSCM. Although GSCM is equipped with a set of tools which facilitate the identification of environmental status of product and process and provide possible directions of solving the problems, it lacks in practical tools and techniques which can be applied efficiently in practice. For example, Life Cycle Assessment is a complex tool which demands professional knowledge and expertise on environmental impacts of product and processes (Rebitzer, etc. 2004). External assistance is often required when a company is devoted to environment management and tries to gain benefits from the program. Fads like LiDS-wheel and MET matrix (IHOBE 2000) are easy to utilize for those having limited environmental know-how, but they are poorly linked to the front-line practices.

- Secondly, GSCM is composed of various aspects of study, ranging from Green Design to End-of-Life Management, and disparate methods are employed in those areas (Srivastava 2007). One of the drawbacks is that the company has to acquaint itself with a variety of tools in GSCM. It is a challenge for the company to execute those techniques by training the employees first. Also, it is difficult to convince the top management who is more managerial competent with less environmental sense. Without comprehensive and profound understandings among employees and whole-hearted and effective support from the top management, the path to success of GSCM in the company is filled with obstacles. Another drawback is that there is lack of a methodology for the company to launch the environment management along the supply chain in a consistent way.
- Lastly, GSCM is advocating the benefits of bringing environmental consideration into the supply chain, without demonstrating the benefit in a concrete fashion. It is agreed on the importance of having the stakeholders behind a program, which builds up the foundation of success. The lucrative benefit is always the reason that lures the stakeholders to support the pursuit of an activity. By showing how much GSCM can save for the company, the top management can be easily taken on board, which is crucial to the triumph of GSCM.

12.4.3 Integrating Six Sigma with Green Supply Chain Management

As illustrated above, there are research gaps in both areas. In this section, the similarities and links between Quality Management and Environment Management are delineated, showing how a “Green Six Sigma” approach would make sense in bringing Six Sigma and GSCM together. Then, it is explained how integrating the two methodologies would complement each other and open a brand-new research focus, which we would call “Green Six Sigma”.

12.4.3.1 Similarities

The similarities shared by GSCM and Six Sigma can be identified on strategic business issue, waste reduction, and product and process design. These three aspects reveal how they can be integrated naturally.

Both quality and environmental issues have become strategic to a company, involving top management, employee training, culture change and integration of business processes. They have similar development and evolution process. Tank (1991) conceptualized five stages in quality program: innocence, awareness, understanding, competence, and excellence. Similar five-stage progression is proposed by Hunt and Auster (1990) for environment management, which are beginner, fire-fighter, concerned citizen, pragmatist and proactivist.

Quality Management (Tank, 1991)	Environment Management (Auster, 1990)
Innocence	Beginner
Awareness	Fire-fighter
Understanding	Concerned citizen
Competence	Pragmatist
Excellence	Proactivist

Table 12.1: Similarities of evolution process

Waste reduction is one of the primary goals in quality management, and it is also the objective shared by GSCM (Zsidisin and Siferd 2001). Waste is the cost to quality and depletion of natural resources, so the management of quality and environment is reaching the objectives by driving waste out of the system.

Design for Six Sigma and Design for Environment are all studied in current research, which indicates how quality management and environment management approach the solution in similar ways. This also implies that the design stage is crucial to both quality and environment and it provide them with proactive action to contribute on the better performance of management.

12.4.3.2 Integration

GSCM provides a broad scope where Six Sigma can be applied and explored, from material purchasing to end-of-life management, and from supplier involvement to customer engagement. Meanwhile, GSCM lacks effective tools, and the techniques in Six Sigma can be used for GSCM with modification.

Six Sigma is aiming at listening to the voice of customers. If the customers and stakeholders are asking for an environmentally sustainable products or production, Six Sigma is a suitable approach to integrate environmental considerations into supply chain management.

GSCM places its focus on proactive solution, while Six Sigma instead uses problem-solving approach to address issues. When the two of them are integrated, thinking-ahead and fire-fighting can be utilized for a variety of situations to achieve continuous improvement.

GSCM needs an efficient methodology to ease the managerial complexity, and Six Sigma can be relied on to fill the gap. First, Six Sigma is a project-centered practice, and it allows the human resource and expertise to vary among projects. This kind of flexibility, on the other hand, is also a way to simplify the organization. Its DMAIC approach allows managing and improving environmental issues in a systematic way. A hierarchy training system is suggested to organize the education of employee involved into green supply chain.

- Executive Leadership includes the members of top management. They are responsible for launching Green Six Sigma implementation.
- Champions act as mentors to Black Belts and are responsible for identifying environmental improvement project.
- Master Black Belts, devote 100% of their time to Green Supply Chain Management. They assist champions and guide Black Belts and Green Belts. Apart from statistical tasks, their time is spent on ensuring consistent application of Six Sigma to environmental issues.
- Black Belts act under Master Black Belts to apply Six Sigma methodology to specific projects. They dedicate 100% of their time to Six Sigma. Their primarily focus is on the project execution.
- Green Belts are the employees who take up Six Sigma implementation along with their other job responsibilities.

Last but not least, Six Sigma values the financial saving gained from each project which would encourage the execution of continuous environmental improvement along the supply chain. It is very important for green practice which is in need of stakeholders' full support.

12.5 Green Six Sigma arising from cases

In order to further support the argument of integrating Six Sigma with GSCM, we would like to highlight several companies practicing Six Sigma with environmental orientation. GE, as a successful pioneer in Six Sigma, has considered environment as one of the strategic issues. In order to be a responsible citizenship, GE places environment into the categories which enable them to make contributions for society in ways that are aligned to the business strategy. Six Sigma approach has been influencing the managerial fashion of the company. Its methodology has penetrated the organization and is supposed to be employed to solve environmental issues to some extent.

In 2007, Ford integrated Six Sigma into the company's core processes. The Six Sigma teams are located in almost every business unit in the company. As environment becomes an increasingly important element in the company development strategy, Six Sigma teams contribute to the improvement of environmental sustainability.

Federchimica is the association of chemical companies in Italy, which incorporates 1350 associated firms. Presently it is planning to launch a project with Politecnico di Milano, with the goal of implementing Six Sigma to reduce the CO₂ emission. This case provides us with the solid evidence that there is a need from industries to apply Six Sigma into the improvement of environmental performance.

Although some companies have not advocated that Six Sigma is used to address environmental issues, the cultural and organizational changes and even the implementing methodologies resulting from Six Sigma would contribute to environmental advancement.

12.6 Conclusion

In the conclusion, the strengths and limitations of integrating Six Sigma and GSCM are discussed, and also the possible study directions are pointed out for future research.

12.6.1 Strengths and limitations of Green Six Sigma

The integration of Six Sigma and GSCM suggests applying the techniques effectively developed in Six Sigma into the management of supply chain sustainability. It could be the way to extend the strength of Six Sigma to the area where the green issues have not been effectively addressed in the supply chain management. Apparently, such integration would overcome some pitfalls in GSCM and renovate the techniques by considering the approach adopted by Six Sigma. On the other hand, it will further exploit the potentiality of Six Sigma. Six Sigma was born to improve quality performance. As it is put into the context of GSCM, the scope of its application is expanded. It creates the framework for those implementing Six Sigma and moving to green practice.

The limitation of Green Six Sigma would be due to the fact that Six Sigma is not a simple methodology, which requires not only the profound understanding of some statistic tools and also the change of company's culture. This could be an issue for those which are not familiar with the method when they are trying to launch Green Six Sigma practices. For instance, Federchimica is planning to first train 100 engineers in its associated companies. The concept of Six Sigma is brand-new to them and it is not sure whether applying this methodology to improve environmental performance will be a positive result.

12.6.2 Further research

The management school of Politecnico di Milano has started a Six Sigma Circle of Italian companies, which builds cases base for us to conduct further study. As Green Six Sigma starts to roll out, manufacturing area would be the point of departure. The suggestions for training and education, how to implement the DMAIC approach, and how to measure the green saving would be the preliminary research questions to be focused on.

Then the attention would be extended to design and purchasing. Even though Green Design and Green Purchasing have already attracted the interests of researcher, academia and practitioners, the interaction between the two areas is still untouched so far. In particular, the application of Six Sigma to them is where our future research focus is. How to apply Six Sigma and to improve the management over Green Design and Green Purchasing would be the general research question. We will address the techniques for Green Six Sigma in product design and purchasing, the workflow between product design and purchasing with environmental consideration, and the identification of project opportunities on these two.

To go further into the techniques development, QFD has been adjusted by taking into account environmental issues (Sakao 2007), and other tools still have the potential be redeveloped in order to fit environmental objectives. Energy, material, packaging and weight could be the aspects where the tools of statistic process control are altered around. Five principles for Green Six Sigma in design and purchasing are reduce, reuse, remanufacture, recycle, and disposal alternatives.

Green Six Sigma has its roots in both GSCM and Six Sigma. It brings forth a new research field to consider environment as a quality issue to manage and improve it along the supply chain. Six Sigma establishes a firm foundation of management methodology, while GSCM regards environment as the focus of research. Green Six Sigma would capitalize on the strength of both of them.

12.7 References

- Arnheiter, ED., & Maleyeff, J 2005, 'The Integration of Lean Management and Six Sigma', *The TQM Magazine*, vol.17, no.1, pp.5-18.
- Basu, R., & Wright, JN 2005, *Quality Beyond Six Sigma*, Butterworth Heinemann.
- Evans, JR., & Lindsay, WM 2005, *The Management and Control of Quality*, 6th edition, Thomson South-Western, pp.479.
- Hunt, CB., & Auster, ER 1990, 'Proactive Environmental Management: Avoiding the Toxic Trap', *Sloan Management Review*, vol.31, no.2, pp.7-18.
- IHOBE 2000, *Handbook for Eco-design Implementation*, Edited by the Basque Country Government.
- Krut, R., & Karasin, L 1999, *Supply Chain Environmental Management: lessons from leaders in the electronics industry*, United States-Asia Environmental Partnership.
- Lenox, M., Jordan, B., & Ehrenfeld, J 1996, 'Diffusion of Design for Environment: a survey of current practice', *Proceedings of the IEEE International Symposium on Electronics and the Environment*, pp. 25–30.
- Min, H., & Galle, WP 1997, 'Green Purchasing Strategies: Trends and Implications', *International Journal of Purchasing and Materials Management*, August.
- Raisinghani, MS 2005, 'Six Sigma: concepts, tools and applications', *Industrial Management and Data System*, vol.105, no.4, pp.491-505.

Rebitzer, G. etc. 2004, 'Life Cycle Assessment Part1: Framework, goal and scope definition, inventory analysis', *Environment International*, vol. 30, pp.701-720.

Sakao, T 2007, 'A QFD-centred Design Methodology for Environmentally Conscious product design', *International Journal of Production Research*, vol.45, no.18-19, pp. 4143-4162.

Srivastava, SK 2007, 'Green Supply-Chain Management: A state-of-the-art literature review', *International Journal of Management Reviews*, vol.9, no. 1, pp.53-80.

Stamatis, DH 2000, 'Who needs Six Sigma anyway?', *Quality Digest e-Store*, available at:www.qualitydigest.com/may00/html/sixsigmacon.html (accessed 30 January 2004).

Tank, AG 1991, 'Global Perspectives on Total Quality', *The Conference Board*, New York, NY.

Yong, J., & Wilkinson, A 2002, 'The Long and Winding road: The evolution of quality management', *Total Quality Management*, vol.13, no.1, pp. 101-121.

Zsidisin, GA., & Siferd, SP 2001, 'Environmental Purchasing: a framework for theory development', *European Journal of Purchasing and Supply Management*, vol.7, pp.61-73.