

2016

# Risk Consideration in Electricity Generation Unit Commitment under Supply and Demand Uncertainty

Narges Kazemzadeh  
*Iowa State University*

Follow this and additional works at: <https://lib.dr.iastate.edu/etd>

 Part of the [Industrial Engineering Commons](#), and the [Operational Research Commons](#)

## Recommended Citation

Kazemzadeh, Narges, "Risk Consideration in Electricity Generation Unit Commitment under Supply and Demand Uncertainty" (2016). *Graduate Theses and Dissertations*. 15944.  
<https://lib.dr.iastate.edu/etd/15944>

This Dissertation is brought to you for free and open access by the Iowa State University Capstones, Theses and Dissertations at Iowa State University Digital Repository. It has been accepted for inclusion in Graduate Theses and Dissertations by an authorized administrator of Iowa State University Digital Repository. For more information, please contact [digirep@iastate.edu](mailto:digirep@iastate.edu).

**Risk consideration in electricity generation unit  
commitment under supply and demand uncertainty**

by

**Narges Kazemzadeh**

A dissertation submitted to the graduate faculty  
in partial fulfillment of the requirements for the degree of  
**DOCTOR OF PHILOSOPHY**

Major: Industrial Engineering

Sarah M. Ryan, Major Professor

Jing Dong

Sigurdur Olafsson

Jo Min

Lizhi Wang

Iowa State University

Ames, Iowa

2016

*To my husband,*

*Mahdi,*

*And to our daughter,*

*Nika.*

## TABLE OF CONTENTS

<b>ACKNOWLEDGEMENTS</b>	<b>vii</b>
<b>ABSTRACT</b>	<b>viii</b>
<b>1. OVERVIEW</b>	<b>1</b>
1.1 Introduction . . . . .	1
1.2 Problem Statement . . . . .	2
1.3 Organization of the Dissertation . . . . .	3
<b>2. ROBUST OPTIMIZATION VS. STOCHASTIC PROGRAMMING CONSIDERING RISK FOR UNIT COMMITMENT WITH UNCERTAIN VARIABLE RENEWABLE GENERATION</b>	<b>6</b>
2.1 Introduction . . . . .	6
2.2 Mathematical Models . . . . .	10
2.2.1 Sets, Parameters, and Decision Variables . . . . .	10
2.2.2 Constraints . . . . .	13
2.2.3 Stochastic Programming Unit Commitment Model Including CVaR (SUC-CVaR) . . . . .	16
2.2.4 Robust Unit Commitment Model (RUC) . . . . .	18
2.3 Scenarios vs. Uncertainty Sets . . . . .	19
2.4 Numerical Experiments . . . . .	22
2.4.1 Implementation details . . . . .	23
2.4.2 Results . . . . .	24
2.5 Conclusions . . . . .	32

<b>3. IMPROVING SOLUTION METHODS FOR ROBUST UNIT COMMITMENT</b>	<b>33</b>
3.1 Introduction . . . . .	33
3.2 The Existing Method . . . . .	35
3.2.1 Outer approximation to evaluate $R(y_1)$ . . . . .	37
3.2.2 Cutting plane method to solve the master problem . . . . .	40
3.3 Branch-and-Cut Method for Solving the Robust Optimization Problem . . . . .	41
3.4 Details of the Formulation . . . . .	46
3.5 Computational Results . . . . .	49
3.6 Conclusions . . . . .	51
<b>4. AN APPROXIMATION FOR CVAR OF ELECTRIC POWER PRODUCTION COST CONSIDERING GENERATING UNIT FAILURES</b>	<b>52</b>
4.1 Introduction . . . . .	52
4.2 Problem Statement . . . . .	56
4.3 Numerical Experiment . . . . .	60
4.4 Conclusions . . . . .	66
<b>5. GENERAL CONCLUSION</b>	<b>68</b>
<b>6. BIBLIOGRAPHY</b>	<b>71</b>

## LIST OF TABLES

Table 2.1	Mean and 95%-confidence intervals (CI) of dispatch, production, penalty, unit commitment and total costs. Unit commitment cost is identical for all scenarios, therefore, a “-” is inserted. . . . .	28
Table 2.2	Mean, 95% lower confidence limit (LCL) and 95% upper confidence limit (UCL) of violations (MWh) . . . . .	30
Table 3.1	Comparison of the proposed branch-and-cut method with the existing cutting plane approach of [8] on instances with different settings. The columns show CPU time in seconds, number of iterations and % gap for the cutting plane approach, and CPU time in seconds and % gap for the branch-and-cut. A “-” means the instance solved to optimality. . . . .	50
Table 4.1	Generating unit data for unconstrained committed set of generators of IEEE RTS-96 test system . . . . .	62
Table 4.2	Sequence of load levels over a 24-hour cycle for IEEE RTS-96 test system . . . . .	63
Table 4.3	Comparison of the CVaR approximation with simulation . . . . .	64
Table 4.4	Generating unit data for constrained committed set of generators of IEEE RTS-96 test system . . . . .	65
Table 4.5	Comparison of the CVaR of the cost for the constrained and unconstrained set of the generators . . . . .	66

## LIST OF FIGURES

2.1	Stepwise startup cost . . . . .	14
2.2	Modified IEEE-RTS-96 . . . . .	23
2.3	Probabilistic scenarios and worst cases in each uncertainty set . . . . .	24
2.4	Distributions of unit commitment cost plus production cost . . . . .	25
2.5	Distributions of total cost . . . . .	26
2.6	Pareto chart of expected shortage vs. unit commitment cost plus expected production cost. . . . .	26
2.7	Pareto chart of penalty cost vs. unit commitment cost from dispatching unit commitment schedules found by different for- mulations and settings in the worst case of $\mathcal{U}_2(\alpha = 0.1)$ . . . . .	29
2.8	Comparison of different penalties for SUC-CVaR ( $\gamma = 0.05$ ), RUC-U1 ( $\Delta = 0.2 N_d $ ) and RUC-U2 ( $\alpha = 0.5$ ) . . . . .	31

## ACKNOWLEDGEMENTS

First and foremost, I would like to take this opportunity to express the deepest thanks to my major professor, Dr. Sarah M. Ryan for her guidance, patience, continuous support of my research and allowing me flexibility to explore ideas that were interesting to me.

I would additionally like to thank my committee members, Dr. Jing Dong, Dr. Jo Min, Dr. Sigurdur Olafsson and Dr. Lizhi Wang for their helpful guidance and feedback.

I also extend my utmost gratitude to my family. Thanks to my parents for encouraging me to pursue graduate education and being my biggest source of inspiration. I cannot thank them enough for supporting me throughout my life. Thanks to my husband, Mahdi, for his continued love, patience and support throughout the graduate school experience, and our daughter, Nika, for all of the joys she has provided since she entered this world.

Finally, I thank God for letting me through all the difficulties. You are the one who provide me with the strength to finish my degree.



## ABSTRACT

Unit commitment (UC) seeks the most cost effective generator commitment schedule for an electric power system to meet net load while satisfying the operational constraints on transmission system and generation resources. This problem is challenging because of the high level of uncertainty in net load which results from load uncertainty and renewable generation uncertainty. This dissertation addresses topics in modeling and computational aspects of considering risk in UC problems.

We investigate and compare the performance of stochastic programming and robust optimization as the most widely studied approaches for unit commitment under net load uncertainty. We explicitly account for risk, via conditional value at risk (CVaR), in the stochastic programming objective function and by employing a CVaR-based uncertainty set in the robust optimization formulation. The numerical results indicate that the stochastic program with CVaR evaluated in a low probability tail is able to achieve better cost-risk trade-offs than the robust formulation. The CVaR-based uncertainty set similarly outperforms an uncertainty set based only on ranges.

Being able to solve UC problem in short amount of time on a daily basis is one of the challenges power system operators face. Therefore, we also adopt a branch-and-cut approach to improve the solution algorithm for robust optimization formulation of the UC problem.

Finally, we present an asymptotic approximation for the CVaR of cost in a power system accounting for generating unit outages. This approximation provides a fast computation of the risk emanating from a set of committed generators due to their imperfect reliability.

## CHAPTER 1. OVERVIEW

### 1.1 Introduction

In recent years, with an ongoing increase in power generation, the power industry plays an important role in modern society. Therefore, a significant amount of attention has been paid to developing a secure, reliable and economic power supply. Unit commitment (UC) is one of the important tasks in electrical power system operations. It is an optimization problem, concerned with slow-responding thermal generating units, to determine the operation schedule of these generating units to meet forecast net load at minimum cost under different constraints and environments. However, there are challenges appearing in the UC problem due to the high level of uncertainty associated with supply and demand of electricity power. In this study, we investigate approaches to address the consideration of risk associated with these sources of uncertainty in the UC problem.

Because of global warming and other environmental issues caused by fossil fuels, there is an increasing interest in using renewable energy resources such as wind or solar. The United States targets to supply 20% of its electricity generation capacity using wind energy by 2030 [1]. Although several regions of the US and world (including Iowa) already well exceed this goal, the most critical challenges to meeting this goal come from increases in variability and uncertainty in net load. Net load is defined as the difference between the load and the output of renewable generation. Uncertainty in net load results from both load uncertainty and renewable generation uncertainty. Another source of

uncertainty associated with UC includes unexpected generator and transmission line outages which may cause difficulties for the scheduled generators to meet the net load.

This dissertation addresses several topics in modeling and computational aspects of considering risk in UC problems.

## 1.2 Problem Statement

Unit commitment, as an important task in electric power system operations, seeks the most cost-effective generator commitment decisions of the system to meet load while satisfying operational constraints on the transmission system and generation resources. This problem is challenging because of the high level of uncertainty in net load which results from load uncertainty and renewable generation uncertainty.

One of the potential solutions to deal with the uncertainty in UC is to increase fixed operating reserves [41]. Reserve is a level of generation resources which is scheduled to respond to generation shortages and prevent load disconnection. Imposing reserve constraints on the UC problem, however, incurs extra operational cost, and does not explicitly model the uncertainty. In contrast, one can employ techniques for optimization under uncertainty. Stochastic unit commitment (SUC) and robust unit commitment (RUC) have been introduced as promising tools to deal with the uncertainty associated with net load forecast. The idea of SUC is to utilize a scenario-based uncertainty representation in the UC formulation. Compared to simply using reserve constraints, stochastic optimization models have certain advantages, such as cost savings and reliability improvement [54, 53]. In contrast to stochastic programming models, RUC models incorporate uncertainty only in terms of the ranges of the uncertain quantities, regardless of the information concerning their underlying probability distributions. Instead of minimizing the total expected cost as seen usually in SUC, RUC minimizes the worst case cost regarding all pos-

sible outcomes of the uncertain parameters within these specified ranges. This type of model certainly produces more conservative solutions; however, it can avoid incorporating a large number of scenarios. Another possibility is to utilize conditional value at risk (CVaR) or other risk measures in combination with these methods. CVaR is a risk measure popular for its coherency properties and computational advantages. Considering the probability density function of loss and  $\gamma$  as a parameter indicating the right tail probability of that function,  $\text{CVaR}_\gamma$  is defined as the expected value in the worst  $100\gamma\%$  of loss [51].

Other uncertainties associated with UC problem include unexpected generator and transmission line outages. Unexpected outages of power grid elements, such as transmission lines and generators, can result in dramatic electricity shortages. Since reliability is important in power grid operations, handling these unexpected outages has become an interesting research area in recent years.

### 1.3 Organization of the Dissertation

The dissertation is organized in a three-paper format, but all the references are combined at the end. It addresses topics of risk consideration in the unit commitment problem under supply and demand uncertainty. These topics include various approaches to considering risk in the unit commitment problem and methodologies to solve the resulting optimization or estimation problems.

In Chapter 2, we study the unit commitment problem with two commonly used approaches; stochastic programming and robust optimization. Our stochastic programming formulation minimizes the start-up and shut-down cost as well as the CVaR of production cost and penalty cost. In the literature, stochastic programs often optimize expected value of cost in the objective function. In contrast, we utilize a risk measure in the objective function to address the risk associated with the cost. One of the challenges in the robust optimization approach is constructing a proper uncertainty set. We consider two approaches to

develop the uncertainty sets. The first approach is to assume that the net load for each time period at each node falls between a lower bound and an upper bound, which can be set to equal certain percentiles of the random load output based on historical data [8, 81]. The second approach is to construct uncertainty sets using historical realizations of the random variables by applying the connection between convex sets and a specific class of risk measures [7]. The goal of this chapter is to study stochastic programming and robust optimization as the most widely used approaches in the unit commitment problem under net load uncertainty in order to compare the solutions and evaluate the effectiveness of these approaches. Numerical results show that the stochastic programming formulation incorporating CVaR can achieve the most efficient combinations of cost and risk. Between the two uncertainty set formulations for robust optimization, the data-driven method results in better cost-risk trade-offs than the uncertainty set based on ranges.

Unit commitment is a problem that must be solved frequently by a power utility or system operator to determine an economic schedule of which units will be used to meet the forecast demand and operating constraints over a short time horizon. Hence, it is crucial to be able to solve the problem in a reasonable amount of time. The UC problem is a mixed-integer programming problem that uses binary variables to represent the commitment of generating units. Due to the use of a large number of binary variables beside many other constraints, RUC is difficult to solve when the size of the problem becomes large.

In Chapter 3, we adopt a branch-and-cut approach to improve the Benders decomposition algorithm for the robust optimization formulation of the UC problem. The drawback of the existing algorithm is that it must solve a mixed-integer programming (MIP) problem in each iteration while this problem becomes larger as cuts are added during the course of the algorithm. As solving a MIP is computationally hard, this approach typically does not converge

even for small sized problems and thus, cannot be a good option for system operators to deal with the real-world instances. The adopted branch-and-cut scheme overcomes this drawback by exploring only a single branch-and-bound tree and dynamically adding linear inequalities to eliminate infeasible solutions and refine the feasible region within that branch-and-bound procedure. Computational results show that the proposed approach makes a remarkable improvement in computation time for the considered instances.

The only source of uncertainty considered in Chapters 2 and 3 is net load uncertainty. However, the reliability of system components is another important concern in power grid operations. Because unexpected outages of power grid elements, such as transmission lines and generators, can result in dramatic electricity shortages, equipment malfunction or failure should also be considered in the UC problem. Most studies addressing this issue enumerate a given set of components as candidates for possible failures [68] or consider all possible component failure scenarios [72]. Enumeration of a large set of failure scenarios requires a lot of computational effort. Therefore, it is worth investigating approaches that do not require enumeration of all possible failure scenarios.

In Chapter 4, we present an asymptotic approximation for the CVaR of cost in the UC problem when generating unit outages occur. Most of the approaches for determining the cost have required enumeration of a large set of failure scenarios which is computationally inefficient. In this study, we apply a different approach to estimate the CVaR of electric power production cost over a specified time horizon. Considering simplifying assumptions, we apply a renewal reward process, an asymptotic central limit theorem, and the definition of CVaR for a normal distribution to achieve this approximation. The results from this approximation are compared with simulation in a large test case.

## CHAPTER 2. ROBUST OPTIMIZATION VS. STOCHASTIC PROGRAMMING CONSIDERING RISK FOR UNIT COMMITMENT WITH UNCERTAIN VARIABLE RENEWABLE GENERATION

### 2.1 Introduction

Unit commitment (UC), one of the most important tasks in electric power system operations, is an optimization problem to make the most cost-effective thermal generator commitment decisions of the system to meet forecast net load while satisfying the operational constraints on transmission system and generation resources [75]. As electricity generation from renewable resources increases, unit commitment faces challenges due to the high level of uncertainty in variable renewable resources such as wind power.

A common remedy to manage the variability and uncertainty in UC is to increase operating reserves [41]. The impact of different levels of reserves is analyzed by [38, 37]. Imposing reserve constraints on the UC problem, however, increases the total operating cost, and does not explicitly capture the uncertainty.

Two approaches for optimizing under uncertainty that have received substantial theoretical development – stochastic programming and robust optimization – have been applied in this context. Although several hybrid methods have also been devised for unit commitment, in this paper we focus on the capability of methods based purely on either probabilistic scenarios or uncertainty sets to control both the cost and the risk associated with day-ahead scheduling in the

presence of uncertain variable renewable generation. We include a risk measure in the stochastic programming formulation and compare the results for two different formulations of the uncertainty set for robust optimization. Numerical results based on out-of-sample simulation suggest that the robust formulation with a “data-driven” uncertainty set provides an efficient cost/risk tradeoff if higher levels of risk are acceptable but the stochastic programming formulation minimizing expected cost in the very low probability upper tail dominates if risk is less tolerable.

Literature reviews of stochastic optimization based unit commitment have been recently done by Zheng et. al [84] and Tahanan et. al. [62]. Stochastic unit commitment (SUC), which has been widely studied [76, 9, 54, 66], formulates the problem as a two-stage optimization problem using probabilistic scenarios. In the first stage, unit commitment decisions choose the binary status of generators to minimize start-up and shut-down costs as well as the expected cost of the second stage decisions. The second stage decisions on the dispatch of each generator committed at the first stage are then made for each scenario [63]. In order to cope with the computational difficulties caused by a large number of scenarios, scenario reduction techniques are used frequently [27, 20]. Benders decomposition [67] and progressive hedging [19, 15] are two methods to improve the performance of solving the SUC with a two-stage structure.

Robust unit commitment (RUC) has also been studied extensively [8, 30, 31, 32, 83, 34, 33]. The unit commitment solutions of the RUC are immunized against all possible realizations of uncertainty. It provides a first stage commitment decision and a second stage dispatch decision while minimizing the dispatch cost under the worst-case realization [8]. Typically, the RUC is also presented in a two-stage formulation; however, there are also multi-stage formulations in the literature [34]. Other variations of RUC are also presented in the literature [5]. Since RUC has a two-stage structure, it can be solved using Benders decomposition approaches [8].



Alternative stochastic optimization formulations and hybrid approaches have also been studied. The Interval UC [61, 73, 44], like RUC, is a scenario based approach that provides a solution by minimizing the cost of central net load forecast while keeping the lower and upper bounds feasible. It also guarantees the feasibility of transitions from lower to upper bound, and vice versa. Among the hybrid approaches, a unified stochastic and robust UC formulation has been extended in [81] to produce less conservative schedules rather than the RUC. Dvorkin et al. [18, 44] proposes a hybrid UC formulation that combines the SUC and interval UC formulations with the goal of achieving a solution that balances the operating cost and robustness.

The concern of scenarios involving extremely rare events which lead to very costly solutions justifies using risk measures in stochastic UC models. In the literature, a common approach considering risk is imposing chance constraints which is equivalent to bounding the Value at Risk (VaR) of the loss. Chance-constrained UC models are used to find commitment schedules that are able to satisfy the power demand of the system with a user-defined reliability level [35, 36, 43, 46]. Wang et al. [70], however, proposed a UC model that includes both the two-stage stochastic program and the chance-constrained stochastic program features. Conditional Value at Risk (CVaR) [51, 50] is a superior measure for risk when compared to chance constraints. Chance-constrained models require extra binary variables, while CVaR can be formulated by continuous variables which make it more computationally tractable. Huang et.al [28] present a two-stage stochastic UC model using CVaR in the constraints. Their model, however, requires a pre-defined maximum tolerable loss for CVaR. To overcome this issue, using CVaR in the objective function is suggested. Bukhsh et. al. applied CVaR to evaluate the risk associated with the mis-estimation of renewable energy [12]. Asensio and Contreras also optimize a weighted combination of expected cost and CVaR of the cost in order to underline the balance between risk and expected costs [6].

There is an ongoing debate in the UC literature to criticize or advocate different approaches of modeling the UC problem. Which approach provides the best schedules is an interesting question. Recently, an interest on comparison of different approaches has emerged. As an example, van Ackooij compares four stochastic methods in unit commitment including probabilistically constrained programming, robust optimization and two-stage stochastic and robust programming focusing on computational aspects as well as flexibility and robustness [65]. A comparison of the computational efficiency of the available UC formulations is made in [45]. Wu et al. compared applications of scenario-based and interval optimization approaches to stochastic security-constrained unit commitment [77]. They found that SUC produces less conservative schedules than the IUC but requires more computing resources. However, Cheung et al. demonstrated that decomposition and parallel computation allow realistically sized SUC instances to be solved in a reasonable amount of time [15].

The contributions of this chapter are summarized as follows. We present a stochastic programming formulation of UC in which we utilize CVaR of the second-stage costs. We refer to this problem as SUC-CVaR. Second, for the robust unit commitment, referred to as RUC, we investigate two formulations of the uncertainty set over which the net load may vary. One formulation of the uncertainty set is defined by a lower bound and upper bound with a budget of uncertainty [8]. The second set is constructed as a combination of historical scenarios using a data driven approach [7] that is related to CVaR. The performance of these methods is assessed in out-of-sample simulation. Because the results of all approaches depend strongly on the risk parameter used, we also provide insights on approaches for practitioners who want to choose appropriate methods for their systems. A branch and cut algorithm is adopted to improve the computational efficiency of Benders decomposition for RUC.

This chapter is organized as follows. In Section 2.2, we introduce the mathematical model along with the definitions of sets, parameters and variables. We

explain scenarios and uncertainty sets in Section 2.3. Numerical experiments and simulation are presented in Section 2.4 in which we make some comparisons with the different formulations and uncertainty sets. Finally, we conclude this paper in Section 2.5.

## 2.2 Mathematical Models

We consider the unit commitment problem for a multi-bus power system based on the formulation presented in [13]. Two different approaches are applied to model the uncertainty of net load, which is load less available variable renewable generation. The first approach is two-stage stochastic programming considering risk. In this approach, the unit commitment decision is made in the first stage before the uncertain parameter values are realized, and the economic dispatch amount is then determined in the second stage for each scenario. In other words, in the first stage, we decide which units must be on in each period of time, and in second stage, the dispatch decisions on power flows are made based to the net load values. The objective function is to minimize first stage costs plus the CVaR of the second stage costs. The second approach is robust optimization. We applied the structure introduced in [8] for the robust optimization model. The objective function has two parts, reflecting the two-stage nature of the decision. The first part is the commitment cost and the second part is the worst case second-stage dispatch cost.

### 2.2.1 Sets, Parameters, and Decision Variables

**Sets:**

$\mathcal{B}$ : Set of buses

$\mathcal{L} \subset \mathcal{B} \times \mathcal{B}$ : Set of transmission lines

$\mathcal{L}_O(b)$ : Set of lines from bus  $b$

$\mathcal{L}_I(b)$ : Set of lines to bus  $b$

$\mathcal{G}$ : Set of thermal generators

$\mathcal{G}(b) \subset \mathcal{G}$ : Set of generators at bus  $b \in \mathcal{B}$

$K$ : Set of indices of the time periods.

$\mathcal{I}_j$ : Set of time intervals of stairwise startup function of thermal unit  $j$

$\mathcal{S}$ : Set of scenarios

**Parameters:**

$d_s(b, k)$ : Net load at bus  $b \in \mathcal{B}$  in period  $k \in K$  for scenario  $s \in \mathcal{S}$  (MW)

$\pi_s$ : Probability of scenario  $s$

$RE(\ell)$ : Reactance of line  $\ell \in \mathcal{L}$  (ohm)

$TL(\ell)$ : Thermal limit (capacity bound) for line  $\ell \in \mathcal{L}$  (MW)

$\underline{P}_j$ : Minimum power output of unit  $j \in \mathcal{G}$  for scenario (MW)

$\overline{P}_j$ : Maximum power output of unit  $j \in \mathcal{G}$  for scenario (MW)

$RD_j$ : Ramp-down limit of unit  $j$  (MW/h)

$RU_j$ : Ramp-up limit of unit  $j$  (MW/h)

$SD_j$ : Shut-down ramp limit of unit  $j$  (MW/h)

$SU_j$ : Start-up ramp limit of unit  $j$  (MW/h)

$DT_j$ : Minimum down-time of unit  $j$  (h)

$UT_j$ : Minimum up-time of unit  $j$  (h)

$v_j(0)$ : Unit  $j$ 's on/off status at time 0 (initial condition) (0/1)

$\hat{v}_j(0)$ : Unit  $j$ 's down-time/up-time status at time 0 (0/1)

$p_{js}(0)$ : Power output of unit  $j$  in period 0 (initial condition) for scenario  $s \in \mathcal{S}$  (MW)

$a_j^1, \dots, a_j^n$ : The slopes of the  $j$ th segment of piecewise linear total production cost function

$b_j^1, \dots, b_j^n$ : The intercept of the  $j$ th segment of piecewise linear total production cost function

$h_j^1, \dots, h_j^{n-1}$ : Breakpoints of the  $j$ th segment of piecewise linear total production cost function

$\Lambda_1, \Lambda_2$ : Penalty weights for non-zero slack variables (\$/MWh)

$\varrho_j(i)$ : Start-up cost of unit  $j$  if getting on in time interval  $i$

$a_j$ : Fixed cost of unit commitment (\$)

$B(\ell)$ : Inverse of (non-zero) reactance on line  $\ell \in \mathcal{L}$  (mho)

If  $RE(\ell) \leq 0$ , then  $B(\ell) = 0$ ; otherwise  $B(\ell) = 1/RE(\ell)$  (mho)

$ITO_j$ : Number of time periods unit  $j$  must be online initially

$ITO_j = \min(|K|, \max(0, \text{round}((UT_j - \hat{v}_j(0))/\tau)))$  (number of time periods)

$ITF_j$ : Number of time periods unit  $j$  must be offline initially

$ITF_j = \min(|K|, \max(0, \text{round}((DT_j + \hat{v}_j(0))/\tau)))$  (number of time periods)

$\gamma$ : Tail probability parameter of CVaR

$\Delta$ : Budget of uncertainty in uncertainty set  $\mathcal{U}_1$

$\alpha$ : Parameter of uncertainty set  $\mathcal{U}_2$

### Decision Variables:

$v_j(k)$ : Binary variable: equals 1 if unit  $j$  is online in period  $k$  and 0 otherwise (0/1)

$p_{js}(k)$ : Power output of unit  $j$  in period  $k$  for scenario  $s \in \mathcal{S}$  (MW)

$\bar{p}_{js}(k)$ : Maximum available power output of unit  $j$  in period  $k$  for scenario  $s$  (MW)

$\theta_{bs}(k)$ : Phase angle for bus  $b$  during time period  $k$  for scenario  $s$  (radians)

$w_{\ell s}(k)$ : Line power for line  $\ell \in \mathcal{L}$  in time period  $k$  for scenario  $s \in \mathcal{S}$  (MW)

$c_{js}^P(k)$ : Total production cost of unit  $j$  in period  $k$  for scenario  $s$  (\$)

$c_j^u(k)$ : Start-up cost of unit  $j$  in period  $k$  (\$)

$c_j^d(k)$ : Shut-down cost of unit  $j$  in period  $k$  (\$)

$\xi_s$ : Production cost and penalty cost for scenario  $s$  (\$)

$\alpha_{bs}^+(k), \alpha_{bs}^-(k)$ : Power balance slack variables at bus  $b$  in period  $k$  for scenario  $s$  (MW)

$\beta_s^+(k), \beta_s^-(k)$ : Reserve requirement slack variables in period  $k$  for scenario  $s$  (MW)

### 2.2.2 Constraints

We use the formulation of [13]. The constraints include UC constraints and non-UC constraints. The UC constraints; i.e., those with only UC variables, include minimum up-time and down-time constraints as well as start-up constraints:

- **Minimum up-time constraints:**

$$\sum_{k=1}^{ITO_j} [1 - v_j(k)] = 0, \quad \forall j \in \mathcal{G} \quad (2.1)$$

$$\sum_{n=k}^{k+UT_j-1} v_j(n) \geq UT_j[v_j(k) - v_j(k-1)],$$

$$\forall j \in \mathcal{G}, \forall k = ITO_j + 1, \dots, |K| - UT_j + 1 \quad (2.2)$$

$$\sum_{n=k}^{|K|} \{v_j(n) - [v_j(k) - v_j(k-1)]\} \geq 0,$$

$$\forall j \in \mathcal{G}, \forall k = |K| - UT_j + 2, \dots, |K| \quad (2.3)$$

- **Minimum down-time constraints:**

$$\sum_{k=1}^{IFT_j} v_j(k) = 0, \quad \forall j \in \mathcal{G} \quad (2.4)$$

$$\sum_{n=k}^{k+DT_j-1} [1 - v_j(n)] \geq DT_j[v_j(k-1) - v_j(k)],$$

$$\forall j \in \mathcal{G}, \forall k = IFT_j + 1, \dots, |K| - DT_j + 1 \quad (2.5)$$

$$\sum_{n=k}^{|K|} \{1 - v_j(n) - [v_j(k) - v_j(k-1)]\} \geq 0,$$

$$\forall j \in \mathcal{G}, \forall k = |K| - DT_j + 2, \dots, |K| \quad (2.6)$$

- **Start-up costs:**

$$c_j^u(k) \geq \varrho_j(i) \left( v_j(k) - \sum_{m=1}^{\min(k-1, i)} v_j(k-m) \right),$$

$$\forall j \in \mathcal{G}, k \in K, i \in \mathcal{I}_j \quad (2.7)$$

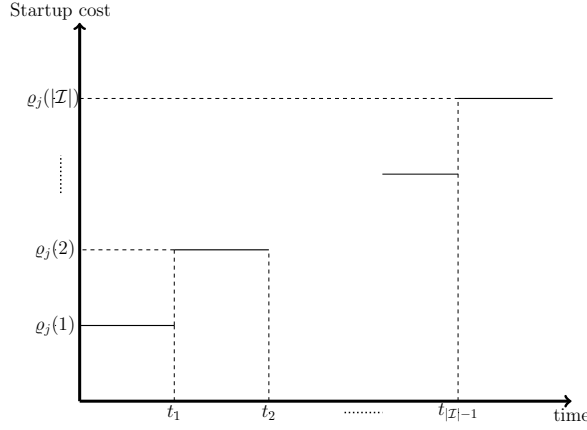

Figure 2.1: Stepwise startup cost

Figure 2.1 displays a plot of the stepwise startup cost function. If unit  $j$  has been on in any of the previous  $t_1$  time periods, the startup cost would be  $\varrho_j(1)$ . Otherwise, if the unit has been on in interval  $[t_1 + 1, t_2]$ , the startup cost would be  $\varrho_j(2)$ , and so on. If the unit has been off within previous  $t_{|\mathcal{I}|-1}$  time intervals, the startup cost would be  $\varrho_j(|\mathcal{I}|)$ . These time intervals are defined as startup lags.

Non-UC constraints are as follows:

- **Line power:**

$$w_{\ell s}(k) = B(\ell) (\theta_{BF(\ell),s}(k) - \theta_{BT(\ell),s}(k)),$$

$$\forall \ell \in \mathcal{L}, k \in K, s \in \mathcal{S} \quad (2.8)$$

$$\theta_{1s}(k) = 0, \quad \forall k \in K, s \in \mathcal{S} \quad (2.9)$$

- **Power balance:**

$$\sum_{j \in \mathcal{G}(b)} p_{js}(k) + \sum_{\ell \in \mathcal{L}_I(b)} w_{\ell s}(k) - \sum_{\ell \in \mathcal{L}_O(b)} w_{\ell s}(k)$$

$$+ \alpha_{bs}^+(k) - \alpha_{bs}^-(k) = d_s(b, k),$$

$$\forall b \in \mathcal{B}, k \in K, s \in \mathcal{S} \quad (2.10)$$

- **Reserve requirement constraints:**

$$\sum_{j \in \mathcal{G}} \bar{p}_{js}(k) = \sum_{b \in \mathcal{B}} d_s(b, k) + R(k) + \beta_s^+(k) - \beta_s^-(k) \quad \forall k \in K, s \in \mathcal{S} \quad (2.11)$$

- **Generation limits:**

$$\underline{P}_j v_j(k) \leq p_{js}(k) \leq \bar{p}_{js}(k), \quad \forall j \in \mathcal{G}, k \in K, s \in \mathcal{S} \quad (2.12)$$

$$0 \leq \bar{p}_{js}(k) \leq \bar{P}_j v_j(k), \quad \forall j \in \mathcal{G}, k \in K, s \in \mathcal{S} \quad (2.13)$$

- **Ramp-up, start-up and shut-down ramp rate:**

$$\begin{aligned} \bar{p}_{js}(k) &\leq p_{js}(k-1) + RU_j v_j(k-1) \\ &\quad + SU_j [v_j(k) - v_j(k-1)] \\ &\quad + \bar{P}_j [1 - v_j(k)], \\ &\quad \forall j \in \mathcal{G}, k \in K, s \in \mathcal{S} \end{aligned} \quad (2.14)$$

$$\begin{aligned} \bar{p}_{js}(k) &\leq p_{js}(k+1) + RD_j v_j(k+1) \\ &\quad + SD_j [v_j(k) - v_j(k+1)] \\ &\quad + \bar{P}_j v_j(k+1), \\ &\quad \forall j \in \mathcal{G}, k = 1, \dots, |K| - 1, s \in \mathcal{S} \end{aligned} \quad (2.15)$$

- **Ramp-down limits on the power output:**

$$\begin{aligned} p_{js}(k-1) - p_{js}(k) &\leq RD_j v_j(k) \\ &\quad + SD_j [v_j(k-1) - v_j(k)] \\ &\quad + \bar{P}_j [1 - v_j(k-1)], \\ &\quad \forall j \in \mathcal{G}, k \in K, s \in \mathcal{S} \end{aligned} \quad (2.16)$$



- **Total production cost:** For  $j \in \mathcal{G}$  and  $s \in \mathcal{S}$

$$c_{js}^P(k) = \begin{cases} a_j^1 p_{js}(k) + b_j^1, & 0 \leq p_{js}(k) \leq h_j^1, \\ a_j^2 p_{js}(k) + b_j^2, & h_j^1 \leq p_{js}(k) \leq h_j^2, \\ \dots & \\ a_j^n p_{js}(k) + b_j^n, & p_{js}(k) \geq h_j^{n-1} \end{cases} \quad (2.17)$$

where  $a_j^1, a_j^2, \dots, a_j^n$  are the slopes of the piecewise linear production cost,  $b_j^1, b_j^2, \dots, b_j^n$  are its intercepts and  $h_j^1, h_j^2, \dots, h_j^{n-1}$  are break points.

- **Variable bounds:**

$$v_j(k) \in \{0, 1\}, \quad \forall j \in \mathcal{G}, \forall k \in K \quad (2.18)$$

$$0 \leq p_{js}(k) \leq \bar{P}_j, \quad \forall j \in \mathcal{G}, k \in K, s \in \mathcal{S} \quad (2.19)$$

$$0 \leq \bar{p}_{js}(k) \leq \bar{P}_j, \quad \forall j \in \mathcal{G}, k \in K, s \in \mathcal{S} \quad (2.20)$$

$$\alpha_s^+(k), \alpha_s^-(k), \beta_s^+(k), \beta_s^-(k) \geq 0, \quad \forall k \in K, s \in \mathcal{S} \quad (2.21)$$

### 2.2.3 Stochastic Programming Unit Commitment Model Including CVaR (SUC-CVaR)

In stochastic programming, we use CVaR as a tractable measure to model the risk associated with the imbalances of net load. In contrast to chance-constrained models requiring additional binary variables, CVaR only involves linear constraints and continuous variables, making it computationally attractive. We include the CVaR of dispatch costs in the objective function to manage the risk associated with production cost, shortage and excess of net load. Considering the probability density function of cost and  $\gamma$  as a parameter indicating the right tail probability of that function,  $\text{CVaR}_\gamma$  is defined as the expected value in the worst  $100\gamma\%$  of the cost distribution. A stochastic programming model including CVaR in the objective function can be formulated as follows:

$$\begin{aligned}
\min \quad & \sum_{k \in K} \sum_{j \in \mathcal{G}} \{c_j^u(k) + c_j^d(k) + a_j v_j(k)\} + \text{CVaR} \{\xi_s, s \in S\} \\
s.t. \quad & \xi_s = \left\{ \sum_{k \in K} \sum_{j \in \mathcal{G}} \pi_s c_{js}^P(k) + \right. \\
& \Lambda_1 \left( \sum_{b \in \mathcal{B}} \sum_{k \in K} \alpha_{bs}^+(k) + \sum_{k \in K} \beta_s^+(k) \right) + \\
& \left. \Lambda_2 \left( \sum_{b \in \mathcal{B}} \sum_{k \in K} \alpha_{bs}^-(k) + \sum_{k \in K} \beta_s^-(k) \right) \right\}, \quad \forall s \in S, \\
& \text{UC and Non-UC Constraints}, \quad \forall s \in S.
\end{aligned}$$

where  $S$  is the set of net load scenarios and  $\pi_s, \forall s \in S$ , is the probability of scenario  $s$ . The CVaR term can be easily reformulated as a linear expression by introducing additional variables and constraints [51]. By applying the definition of CVaR for a discrete distribution, the above formulation can be linearized as follows:

$$\begin{aligned}
\min \quad & \sum_{k \in K} \sum_{j \in \mathcal{G}} \{c_j^u(k) + c_j^d(k) + a_j v_j(k)\} + \\
& \left\{ \eta + \frac{1}{\gamma} \sum_{s \in S} \pi_s r_s \right\} \\
s.t. \quad & \xi_s = \left\{ \sum_{k \in K} \sum_{j \in \mathcal{G}} \pi_s c_{js}^P(k) + \right. \\
& \Lambda_1 \left( \sum_{b \in \mathcal{B}} \sum_{k \in K} \alpha_{bs}^+(k) + \sum_{k \in K} \beta_s^+(k) \right) + \\
& \left. \Lambda_2 \left( \sum_{b \in \mathcal{B}} \sum_{k \in K} \alpha_{bs}^-(k) + \sum_{k \in K} \beta_s^-(k) \right) \right\}, \quad \forall s \in S, \\
& r_s \geq 0, \quad \forall s \in S, \\
& r_s \geq \xi_s - \eta, \quad \forall s \in S, \\
& \text{UC and Non-UC Constraints}, \quad \forall s \in S.
\end{aligned}$$

### 2.2.4 Robust Unit Commitment Model (RUC)

The RUC formulation incorporates uncertainty only in terms of ranges of the uncertain parameters. The following formulation is based on the model presented in [8].

$$\begin{aligned}
\min \quad & \sum_{k \in K} \sum_{j \in \mathcal{G}} \{c_j^u(k) + c_j^d(k) + a_j v_j(k)\} + \\
& \max_{d \in \mathcal{U}} \left\{ \sum_{k \in K} \sum_{j \in \mathcal{G}} c_j^P(k) + \right. \\
& \Lambda_1 \left( \sum_{b \in \mathcal{B}} \sum_{k \in K} \alpha_b^+(k) + \sum_{k \in K} \beta^+(k) \right) + \\
& \left. \Lambda_2 \left( \sum_{b \in \mathcal{B}} \sum_{k \in K} \alpha_b^-(k) + \sum_{k \in K} \beta^-(k) \right) \right\} \\
s.t. \quad & \text{UC and Non-UC Constraints} \quad \forall d \in \mathcal{U}
\end{aligned}$$

where  $\mathcal{U}$  is the uncertainty set of the net loads. The only uncertain parameter in this formulation is the net load  $d(b, k)$  which consists of the net loads of each bus  $b$  at each time period  $k$ . For this study we consider two distinct definitions for uncertainty set. We will explain how we describe them using scenarios in Section 2.3. Because the variables and constraints in this formulation no longer depend on scenarios, we omitted index  $s$  from both the variables and the constraints.

The above formulation can be recast in the following equivalent form:

$$\begin{aligned}
\min_{y_1} \quad & \sum_{k \in K} \sum_{j \in \mathcal{G}} \{c_j^u(k) + c_j^d(k) + a_j v_j(k)\} \\
& + \max_{d \in \mathcal{U}} \min_{y_2 \in \Omega(y_1, d)} \left\{ \sum_{k \in K} \sum_{j \in \mathcal{G}} c_j^P(k) + \right. \\
& \Lambda_1 \left( \sum_{b \in \mathcal{B}} \sum_{k \in K} \alpha_b^+(k) + \sum_{k \in K} \beta^+(k) \right) + \\
& \left. \Lambda_2 \left( \sum_{b \in \mathcal{B}} \sum_{k \in K} \alpha_b^-(k) + \sum_{k \in K} \beta^-(k) \right) \right\} \tag{2.22}
\end{aligned}$$

*s.t.* UC Constraints

where

$y_1$  = UC (first stage) variables

$$= \{v_j(k), c_j^u(k), c_j^d(k) \forall j \in \mathcal{G}, \forall k \in K\}$$

$y_2$  = Non-UC (second stage) variables

$$= \left\{ p_j(k), \bar{p}_j(k), \theta_j(k), w_j(k), c_j^P(k), \right. \\ \left. \alpha_b(k), \alpha_b^+(k), \alpha_b^-(k), \beta(k), \right. \\ \left. \beta^+(k), \beta^-(k), \forall j \in \mathcal{G}, k \in K \right\}$$

$$\Omega(y_1, d) = \{y_2 | \text{non-UC Constraints, given } y, d\}$$

### 2.3 Scenarios vs. Uncertainty Sets

In the stochastic programming approach, the uncertain parameter is captured by a number of probabilistic scenarios, whereas in the robust optimization approach, the range of values of the uncertain parameter is defined by a domain. To make a reasonable comparison, it is necessary to define uncertainty sets consistent with the scenarios used for the stochastic programming model. For RUC, constructing a proper uncertainty set plays an important role in determining the conservativeness of the model [24]. The uncertainty set is often defined by a lower bound and an upper bound on the uncertain parameter based on the mean value and volatility of the distribution. Jiang et al. [32] introduced a two-dimensional uncertainty set to describe the uncertain problem parameters. Lorca and Sun [33] proposed dynamic uncertainty sets. Dai et al. [16] applied a multi-band uncertainty set that helps to avoid overly conservative solutions.

Distributionally robust optimization (DRO) is a moderately data-driven approach in which the true distribution of a random variable is unknown and assumed to fall within a confidence set. In this method, the uncertain quantity is represented as random variable over a family of distributions characterized

by its descriptive statistics. The advantage of this method is being based on the historical data and its solutions are robust to distributional assumptions. However, it is less conservative and also requires more information to derive descriptive statistics. An example of a DRO model for UC considering uncertain wind power generation can be found in [78]. Gourtani et. al. applied a distributionally robust modeling framework for the unit commitment problem with supply uncertainty with  $n - 1$  security criteria [23]. Zhang et. al. formulate a chance constrained optimal power flow problem to procure minimum cost energy, generator reserves, and load reserves given uncertainty in renewable energy production, load consumption, and load reserve capacities and solve it with DRO, which ensures that chance constraints are satisfied for any distribution in a confidence set [80]. Zhao et. al constructed the confidence sets utilizing the  $L_1$  norm and  $L_\infty$  norm in a data-driven environment [82].

In this study, we consider two approaches to develop the uncertainty sets. The first approach is to assume the net load for each time period at each node falls between a lower and an upper bound, which can be set by certain percentiles of the random load output based on historical data [8, 81]. Note that a scenario specifies the net load for each hour and each bus in the scheduling horizon. A parameter called the budget of uncertainty is defined to control the deviation of all loads from their nominal values. According to [8] the uncertainty set can be described as follows:

$$\mathcal{U}_1 := \left\{ d_b^k : \sum_{b \in N_d} \frac{|d_b^k - \bar{d}_b^k|}{\hat{d}_b^k} \leq \Delta^k, d_b^k \in [\bar{d}_b^k - \hat{d}_b^k, \bar{d}_b^k + \hat{d}_b^k], \right. \\ \left. \forall b \in N_d, \forall k \in K \right\}$$

where  $N_d$  is the set of buses that have uncertain load,  $\bar{d}_b^k$  is the nominal value of load and  $\hat{d}_b^k$  is the maximum possible deviation of load of bus  $b$  at time  $k$  from the nominal value. The parameter  $\Delta^k$  is the budget of uncertainty, taking values between 0 and  $|N_d|$ . When  $\Delta^k = 0$ , the robust formulation corresponds to the deterministic case. As  $\Delta^k$  increases, the uncertainty set enlarges, which

results in more conservative UC solutions. The maximum amount of deviation that can be considered for the net load in each period is  $|N_d|$ .

Our second approach is to construct uncertainty sets using historical realizations of the random variables by applying a connection between convex sets and a specific class of risk measures [7]. It is proved that a constraint with a coherent risk measure can be equivalently written as a constraint with a corresponding convex uncertainty set [7]. In other words, we can formulate the optimization problem with uncertain data as a robust optimization problem with a convex uncertainty set related to a coherent risk measure. This risk measure expresses the decision maker's risk preference. We apply the link between CVaR as a coherent risk measure and polyhedral uncertainty sets to define an uncertainty set based on scenarios. Enforcing a constraint in which  $\text{CVaR}_\alpha$  of a term is less than or equal to zero roughly means that the expected value of that term, in the 100  $\alpha\%$  worst cases, is no less than zero. Here  $\alpha = r/N$  where  $r$  and  $N$  are described in the following.

Given  $N$  data points; i.e.,  $s_1, s_2, \dots, s_N$ , the uncertainty set corresponding to  $\text{CVaR}_\alpha$  is

$$\mathcal{U}_2 := \text{conv} \left( \left\{ \frac{1}{\alpha} \sum_{i \in I} \pi_i s_i + \left(1 - \frac{1}{\alpha} \sum_{i \in I} \pi_i\right) s_j : \right. \right. \\ \left. \left. I \subseteq \{1, \dots, N\}, j \in \{1, \dots, N\} \setminus I, \sum_{i \in I} \pi_i \leq \alpha \right\} \right),$$

where  $\text{conv}(\cdot)$  denotes the convex hull.

Assuming the probability distribution of sample points  $s_i$  as  $\pi_i = 1/N$ , each of which represents one observation of demand  $\{d(b, k)\}$ , and considering  $\alpha = r/N$  for some  $r \in \mathbb{Z}^+$ , this has the interpretation of the convex hull of all  $r$ -point averages the demand observations. Let

$$\mathcal{F} := \left\{ \frac{1}{\alpha} \sum_{i \in I} \pi_i s_i + \left(1 - \frac{1}{\alpha} \sum_{i \in I} \pi_i\right) s_j : \right. \\ \left. I \subseteq \{1, \dots, N\}, j \in \{1, \dots, N\} \setminus I, \sum_{i \in I} \pi_i \leq \alpha \right\}.$$

be the set of all possible points for a certain  $\alpha$  value. Because  $\mathcal{F}$  has finitely many elements, we can write it as  $\mathcal{F} = \{f_1, \dots, f_m\}$  for some finite  $m$ . To define the uncertainty set, we introduce a decision variable  $\mu_i$  corresponding to each  $f_i, i = 1, \dots, m$ . Since each scenario has dimension  $|\mathcal{B}| \times |K|$ , the elements of the uncertainty set are represented as  $f_i^{b,k}$ . The convex hull term in the definition of  $\mathcal{U}_2$  can be formulated as the following:

$$\mathcal{U}_2 := \left\{ (\mu, d) \in \mathbb{R}^m \times \mathbb{R}^{|\mathcal{B}| \times |K|} : \sum_{i=1}^m \mu_i f_i^{b,k} = d^{b,k}, \forall b, k, \right. \\ \left. \sum_{i=1}^m \mu_i = 1, \mu_i \geq 0, i = 1, \dots, m \right\}.$$

Here, the parameter  $\alpha$  takes values between 0 and 1. As  $\alpha$  decreases, the uncertainty set enlarges, so that the resulting robust solutions are more conservative and the system is protected against a higher degree of uncertainty.

## 2.4 Numerical Experiments

To test the approaches, we adopted the modified 24-bus IEEE RTS-96 system [74] with 32 generators and 38 transmission lines using data from [4]. The power system network is displayed in Figure 2.2. The data set includes hourly demand data for one year. Three wind farms are added to the grid as in [44] with wind scenarios extracted from the NREL wind data sets [3]. The penalty cost coefficients were arbitrarily set with values of  $\Lambda_1 = 20$  \$/MWh for deficits and  $\Lambda_2 = 1$  \$/MWh for excess. These relatively modest values allow shortages to occur in an exaggerated way which allows comparison of risks. They are revisited in a sensitivity study at the end of this section.

The wind data set contains 365 scenarios, assumed as equally likely. We used the fast forward selection algorithm [27] to reduce the number of scenarios to 10 [44]. The reduced set of scenarios included one assigned a probability of 0.59, three with probabilities of 0.09, 0.11 and 0.12, respectively, and the remainder with probabilities below 0.05 including two with probability 1/365.

They are categorized as high-, medium- and low-probability, respectively, and the corresponding net load scenarios, aggregated over the buses, are plotted as 24-hour time series in Fig. 2.3. The problems are solved using these 10 scenarios, and out-of-sample testing of the solutions is done by Monte Carlo simulation with the other 355 scenarios. The plot also shows the bus-aggregated worst cases identified in each of the RUC optimizations, as described below.

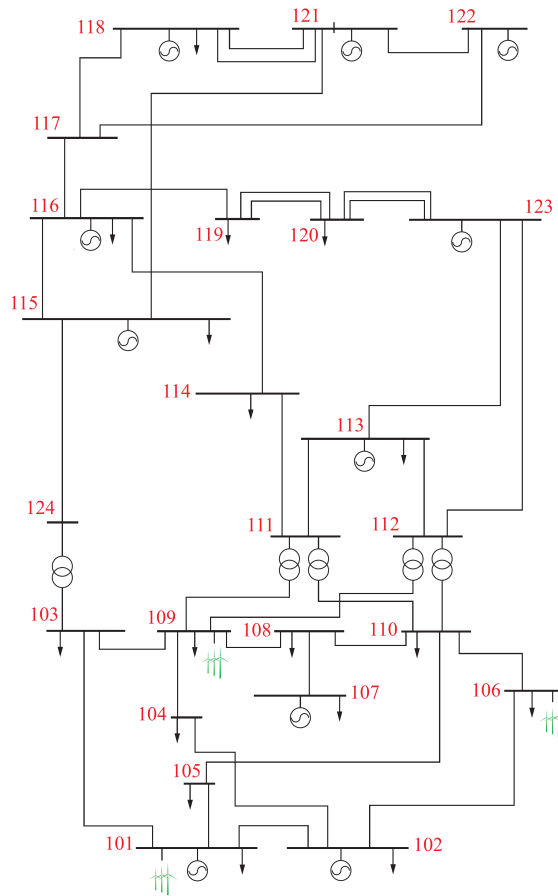

Figure 2.2: Modified IEEE-RTS-96

#### 2.4.1 Implementation details

We implemented all algorithms in Python 2.7 and employed CPLEX Python API 12.5 as the integer programming solver. A Benders decomposition based



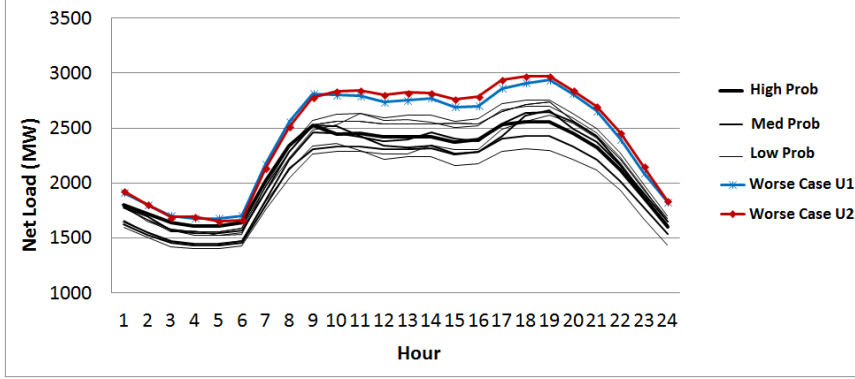

Figure 2.3: Probabilistic scenarios and worst cases in each uncertainty set

algorithm proposed in [8] was applied to solve the RUC. We adopted a branch and cut modification [42] for this Benders decomposition which makes it orders of magnitude faster.

#### 2.4.2 Results

The results of solving the problem using different approaches were evaluated according to the costs of optimally dispatching the committed units in the out-of-sample simulation. Total costs include dispatch and unit commitment cost:

$$\text{Total Cost} = \text{Dispatch Cost} + \text{Unit Commitment Cost},$$

where

$$\text{Dispatch Cost} = \text{Production Cost} + \text{Penalty Cost}.$$

The production cost is computed from Equation (7) as:

$$\text{Production Cost} = \sum_{j \in \mathcal{G}} \sum_{k \in K} c_j^P(k).$$

We also compute the penalties of deficit and excess of demand requirements as

$$\text{Penalty Cost} = \Lambda_1 \sum_{k \in K} \sum_{b \in \mathcal{B}} \alpha_b^+(k) + \Lambda_2 \sum_{k \in K} \sum_{b \in \mathcal{B}} \alpha_b^-(k).$$

The unit commitment cost includes the start-up, shut-down cost and no-load costs:

$$\text{Unit Commitment Cost} = \sum_{k \in K} \sum_{j \in \mathcal{G}} \{c_j^u(k) + c_j^d(k) + a_j v_j(k)\}.$$

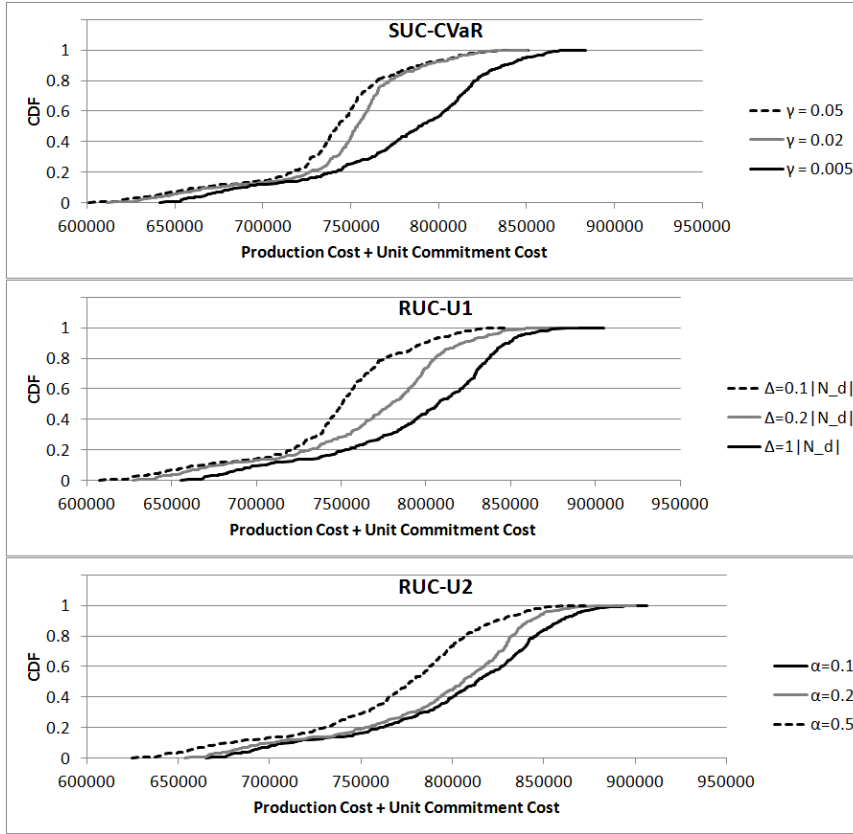

Figure 2.4: Distributions of unit commitment cost plus production cost

Figs. 2.4 and 2.5 show the comparison of distributions of the unit commitment cost plus the production cost, and the total cost, respectively. The plots suggest that SUC-CVaR results in slightly higher total cost compared to both RUC models. SUC-CVaR results in more violation and consequently more penalty cost in comparison with RUC; however, it has lower unit commitment cost.

Details of the costs including their means and confidence interval widths are summarized in Table 2.1. We comment on the results of this table by fo-

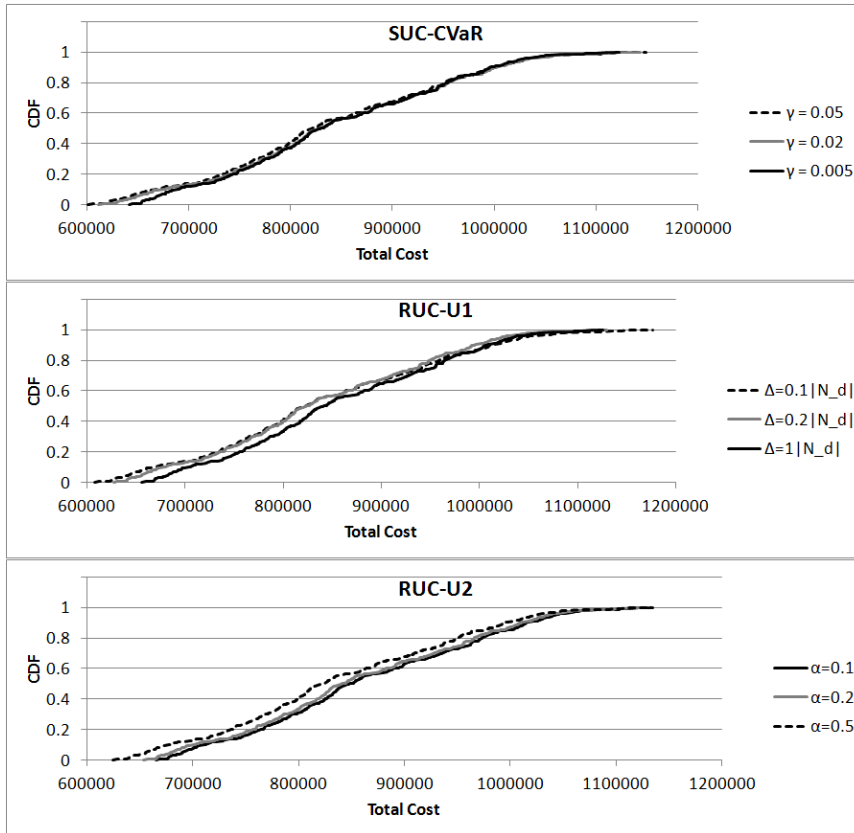

Figure 2.5: Distributions of total cost

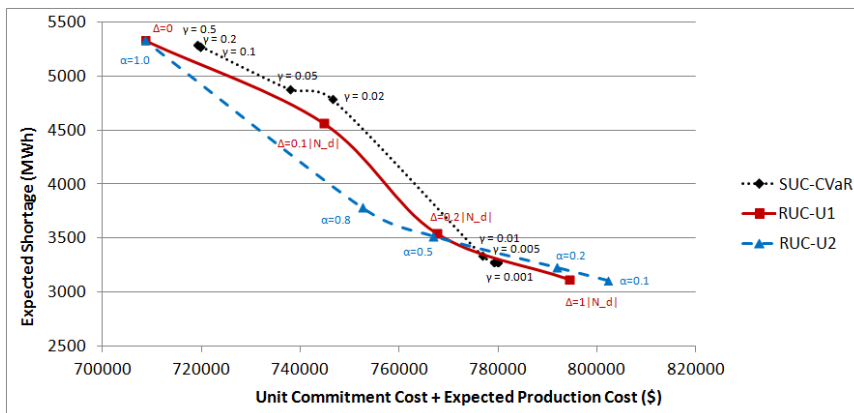

Figure 2.6: Pareto chart of expected shortage vs. unit commitment cost plus expected production cost.

cusing on settings for each approach with almost equal expected total cost; i.e., SUC-CVaR with  $\gamma = 0.05$ , RUC- $\mathcal{U}_1$  with  $\Delta = 0.2|N_d|$  and RUC- $\mathcal{U}_2$  with  $\alpha = 0.5$ . The unit commitment cost of SUC-CVaR is significantly lower than in both RUC formulations. In fact, two generators that were never committed by SUC were kept operating continuously by both RUC models. However, SUC-CVaR's expected penalty cost is about 30% higher than those of the RUC models. SUC-CVaR has higher expected production cost than RUC- $\mathcal{U}_2$  with 95% confidence, but its production cost confidence interval overlaps with that of RUC- $\mathcal{U}_1$ . Overall, the cost comparison indicates that the SUC-CVaR emphasizing the 5% tail is less conservative than the RUC formulations. To compare uncertainty sets  $\mathcal{U}_1$  and  $\mathcal{U}_2$ , one can see that although the unit commitment cost of RUC- $\mathcal{U}_2$  with  $\alpha = 0.5$  is higher than the unit commitment cost of RUC- $\mathcal{U}_1$  with  $\Delta = 0.2|N_d|$ , RUC- $\mathcal{U}_2$  results in less violation and, therefore, it is more reliable. This conclusion is reinforced by Table 2.2, which contains mean and confidence intervals of the violation of constraints (3).

The level of conservatism can be adjusted in all three methods by adjusting the extent of the uncertainty sets considered in the RUC formulations or the tail probability in the SUC-CVaR formulation. Fig. 2.6 presents a Pareto chart to illustrate the tradeoff between cost and reliability. It indicates that, if a decision-maker emphasizes cost by setting  $\Delta$  small, or  $\alpha$  or  $\gamma$  large, then the data-driven RUC- $\mathcal{U}_2$  achieves the most efficient combinations of expected cost and expected shortage. When these parameters are adjusted for higher conservatism, RUC- $\mathcal{U}_1$  dominates. But at the most stringent risk-minimizing parameter settings, the CVaR-adjusted SUC formulation may achieve a better cost-reliability tradeoff than either RUC formulation. Because the confidence intervals on the expected cost and shortage values overlap, these findings should be verified in more extensive numerical tests using the particular system parameters and penalty values chosen by the system operator.

Table 2.1: Mean and 95%-confidence intervals (CI) of dispatch, production, penalty, unit commitment and total costs. Unit commitment cost is identical for all scenarios, therefore, a “-” is inserted.

		Costs					
		Dispatch	Production	Penalty	UC	Total	
SUC-CVaR	$\gamma = 0.005$	Mean	675628	609762	65866	169404	845032
		CI	(663843, 687412)	(604175, 615349)	(59108, 72624)	-	(833247, 856816)
	$\gamma = 0.02$	Mean	712531	616109	96421	130263	842794
		CI	(700060, 725002)	(611555, 620664)	(87890, 104953)	-	(830323, 855265)
	$\gamma = 0.05$	Mean	706469	607411	99058	130408	836877
		CI	(693805, 719132)	(602697, 612124)	(90610,107505)	-	(824213, 849540)
RUC- $\mathcal{U}_1$	$\Delta = 1 N_d $	Mean	673855	611263	62592	183098	856953
		CI	(662205, 685505)	(605738, 616788)	(55820, 69363)	-	(845303, 868603)
	$\Delta = 0.2 N_d $	Mean	669423	597680	71743	169756	839179
		CI	(657349, 681498)	(592235, 603126)	(64523, 78963)	-	(827104, 851253)
	$\Delta = 0.1 N_d $	Mean	677878	581422	96456	163259	841137
		CI	(664714, 691042)	(576535, 586308)	(87673, 105239)	-	(827973, 854301)
RUC- $\mathcal{U}_2$	$\alpha = 0.1$	Mean	682919	620506	62414	181557	864476
		CI	(671255, 694584)	(614919, 626092)	(55764, 69064)	-	(852812, 876140)
	$\alpha = 0.2$	Mean	673395	608360	65035	183444	856839
		CI	(661632, 685158)	(602924, 613796)	(58010, 72060)	-	(845076, 868603)
	$\alpha = 0.5$	Mean	666965	595437	71528	171259	838224
		CI	(654845, 679086)	(589940, 600935)	(64374, 78682)	-	(826104, 850345)

Because the RUC models are designed to protect against the worst case, it is instructive to compare their worst case performances. As a byproduct of the unit commitment optimization, we obtain the net load sequence that embodies the worst case. These worst case bus-aggregated load sequences are shown in Fig. 2.3; note that the aggregation causes them to appear to fall outside the envelope of scenarios used to construct the uncertainty sets. We evaluated the commitment decisions of each method and each risk parameter setting by dispatching them against the worst-case net loads identified in the largest uncertainty sets according to both formulations. Fig. 2.7 shows a Pareto chart of the penalty cost vs. the unit commitment plus production cost for the worst case of  $\mathcal{U}_2(\alpha = 0.1)$ ; the same chart for the worst case of  $\mathcal{U}_1(\Delta = |N_d|)$  appears similar. The most efficient trade-offs between cost and mismatch penalty are achieved by SUC-CVaR.

In another experiment, we assess the sensitivity of the models using intermediate values of the risk parameters with respect to penalty coefficients (i.e.,  $\Lambda_1$  and  $\Lambda_2$ ). Figure 2.8 shows that as the penalty coefficients rise, the RUC models respond with higher total cost whereas SUC-CVaR does not react as much.

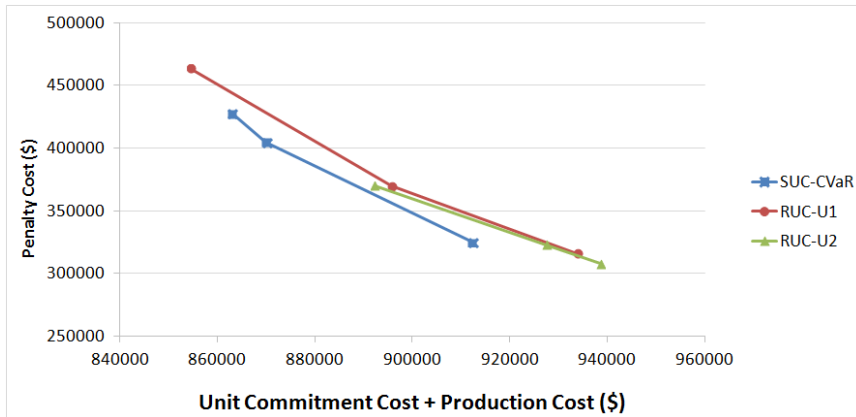

Figure 2.7: Pareto chart of penalty cost vs. unit commitment cost from dispatching unit commitment schedules found by different formulations and settings in the worst case of  $\mathcal{U}_2(\alpha = 0.1)$

Table 2.2: Mean, 95% lower confidence limit (LCL) and 95% upper confidence limit (UCL) of violations (MWh)

			Violations		
			Total	Shortage	Excess
SUC-CVaR	$\gamma = 0.005$	Mean	3280.23	3280.23	0.00
		LCL	2945.42	2945.42	-
		UCL	3615.03	3615.03	-
	$\gamma = 0.02$	Mean	4787.28	4787.28	0.00
		LCL	4367.38	4367.38	-
		UCL	5207.18	5207.18	-
	$\gamma = 0.05$	Mean	4877.35	4877.35	0.00
		LCL	4468.10	4468.10	-
		UCL	5286.60	5286.60	-
RUC- $\mathcal{U}_1$	$\Delta = 1 N_d $	Mean	3116.64	3116.64	0.00
		LCL	2780.71	2780.71	-
		UCL	3452.57	3452.57	-
	$\Delta = 0.2 N_d $	Mean	3548.32	3548.32	0.00
		LCL	3194.80	3194.80	-
		UCL	3901.83	3901.83	-
	$\Delta = 0.1 N_d $	Mean	4566.04	4566.04	0.00
		LCL	4167.97	4167.97	-
		UCL	4964.11	4964.11	-
RUC- $\mathcal{U}_2$	$\alpha = 0.1$	Mean	3108.63	3108.61	0.03
		LCL	2778.54	2778.51	-0.02
		UCL	3438.72	3438.70	0.08
	$\alpha = 0.2$	Mean	3227.89	3227.88	0.02
		LCL	2880.84	2880.82	-0.02
		UCL	3574.95	3574.94	0.05
	$\alpha = 0.5$	Mean	3520.90	3520.90	0.00
		LCL	3173.50	3173.50	-
		UCL	3868.30	3868.30	-

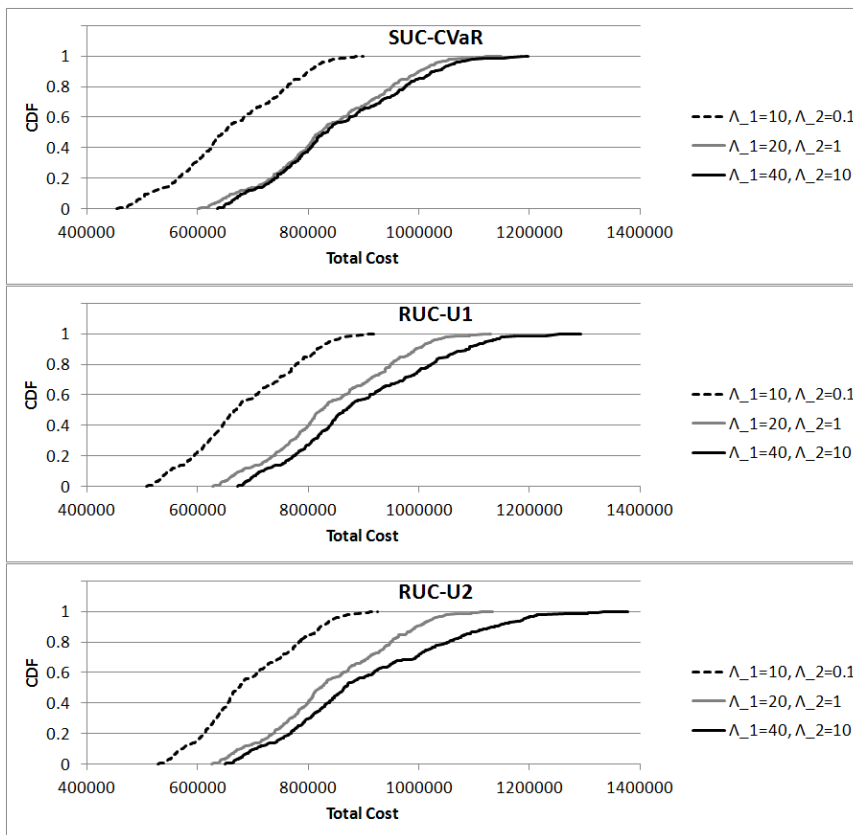

Figure 2.8: Comparison of different penalties for SUC-CVaR ( $\gamma = 0.05$ ), RUC-U1 ( $\Delta = 0.2|N_d|$ ) and RUC-U2 ( $\alpha = 0.5$ )



## 2.5 Conclusions

Robust optimization and stochastic programming have been extensively discussed and studied as alternatives to optimize unit commitment schedules under uncertainty. A popular impression has arisen that the robust approach, with its focus on the worst case, is better able to control risk while stochastic programming emphasizes expected values. However, the stochastic programming formulation can easily accommodate a risk measure. Moreover, the results of both methods depend strongly on the model for the uncertain parameters – either the uncertainty set or the probabilistic scenarios employed in the optimization. To compare both approaches on the same information basis, we constructed uncertainty sets by two methods based on the same reduced set of scenarios used in the stochastic programming formulation. The schedules found by each approach for various risk parameter values were evaluated in an out-of-sample simulation.

The numerical results indicate that the cost-risk trade-off achieved by any approach is strongly influenced by the value of its respective risk parameter. By incorporating risk in the stochastic programming formulation in terms of CVaR with a sufficiently low tail probability, the stochastic programming formulation can achieve the most efficient combinations of cost and risk. Notably, it provides schedules that perform best should the worst case (determined according to either uncertainty set) occur. Between the two uncertainty set formulations for robust optimization, the data-driven method that incorporates probabilities of scenarios as well as their ranges of values achieves better cost-risk trade-offs than the one based on ranges alone.

## CHAPTER 3. IMPROVING SOLUTION METHODS FOR ROBUST UNIT COMMITMENT

### 3.1 Introduction

Unit commitment (UC) is a problem that must be solved frequently by a power utility or system operator to determine an economic schedule of which units will be used to meet the forecast demand and operating constraints over a short time horizon. For example, the California Independent System Operator considers a one-hour time period between 10:00 a.m. and 11:00 a.m. on the day before the targeted day to receive and evaluate bids from market participants, solve the UC problem, and publish the results [2]. Hence, it is crucial to be able to solve the problem by the end of the period.

The UC problem is a mixed-integer programming problem that uses binary variables to represent the commitment of generating units. Due to the use of a large number of binary variables beside many constraints, UC is in the class of NP-hard problems and is difficult to solve when the size of the problem becomes large [64].

The robust unit commitment (RUC) model is one of the most studied approaches to address uncertainties associated with renewable resources. In the literature, RUC is mostly formulated as a two-stage programming problem in which the first stage determines the commitment decisions and the second stage makes dispatch decisions after the uncertainty is resolved. The RUC problem is a multi-stage mixed-integer program and is normally difficult to solve. Therefore, improving solution methods for this problem is of importance.

The process of solving RUC is a version of Benders decomposition [8]. Benders decomposition may cause a major computational bottleneck as the master problem is solved repeatedly. The master problem is an integer program that becomes more difficult as more inequalities are added in the course of the algorithm. A number of studies have been dedicated to alleviating this problem. Rei et al. propose a local branching approach to be used within Benders decomposition to improve the lower and upper bounds at each iteration [49]. Saharidis et al. introduce a new way to generate multiple cuts by solving an auxiliary problem based on the solution of the master problem. They show that this methodology significantly decreases the number of iterations and the computational time [57]. Saharidis and Ierapetritou presented a maximum feasible subsystem cut generation approach where at each iteration of the Benders algorithm, an extra cut is generated to restrict the value of the objective function of the master problem. This strategy focuses on the particular case where more feasibility than optimality Benders cuts are produced. The proposed algorithm was shown to significantly reduce the computational time [58].

In this study, we apply a branch-and-cut algorithm presented in [42] for integer programs based on Benders decomposition. Branch-and-cut, one of the main solution methodologies for mixed integer programming, is a combination of branch-and-bound and cutting plane approaches. In the branch-and-cut algorithm, a linear relaxation is solved at each node of the branch-and-bound tree. Valid cuts are added to eliminate integer solutions that violate the relaxed constraints. After adding inequalities, if the solutions remain fractional, branching is performed.

We implement this method on a UC formulation based on [13]. An alternative formulation to the deterministic UC which is widely recognized to be more efficient is presented by [40]. However, the implementation of this method would be the same on the alternative formulation and it could be explored to show improvement.

This chapter is organized as follows. In Section 3.2 we explain the solution method for the robust optimization formulation which is adopted from Bertsimas et al. [8]. In Section 3.3 we propose a branch-and-cut algorithm to improve the solution methods for this robust unit commitment problem. We also provide the details of the subproblems and inequalities used to solve the RUC in Section 3.4. Computational results are summarized in Section 3.5. Finally, we conclude this Chapter in Section 3.6.

### 3.2 The Existing Method

In this section, a variant of Benders decomposition [8] is applied for the proposed robust optimization unit commitment problem. We first present the RUC formulation. We write  $y_1$  for the UC variables that are independent of uncertainty; i.e., the unit commitment, start-up and shut-down cost variables. Also, we write  $y_2$  for the dispatch variables (recall that the dispatch variables may depend on the values of uncertain parameters, e.g. power output, phase angle, production cost). The uncertain parameters (in our problem, the hourly net load) can vary on a set denoted as  $D$ . The RUC is then summarized as

$$\min_{y_1, y_2} \left( c^T y_1 + \max_{d \in D} b^T y_2(d) \right) \quad (3.1a)$$

$$s.t. \quad \mathbf{F}y_1 \leq \mathbf{f}, \quad (3.1b)$$

$$\mathbf{H}y_2(d) \leq \mathbf{h}, \quad d \in D \quad (3.1c)$$

$$\mathbf{A}y_1 + \mathbf{B}y_2(d) \leq \mathbf{g}, \quad d \in D \quad (3.1d)$$

$$\mathbf{E}y_2(d) = d, \quad d \in D \quad (3.1e)$$

$$y_1 \in \mathbb{R}^{n_1} \times \{0, 1\}^{p_1}, \quad (3.1f)$$

$$y_2(d) \in \mathbb{R}^{n_2}, \quad d \in D. \quad (3.1g)$$

In Problem (3.1), the objective function (3.1a) minimizes a combination of unit commitment costs, such as start-up and shut-down costs, and the worst case of the dispatch costs, such as production and shortage costs. Constraint (3.1b)

only defines feasibility of the unit commitment variables. Constraint (3.1c) involves both the unit commitment decisions and dispatch variables, such as ramp-up and ramp-down constraints. In constraint (3.1d), we only constraint dispatch variables, such as power balance equations. Note that dispatch variables depend on the uncertain parameter  $d$ . Finally, we have restrictions on decision variables: unit commitment variables are mixed-integer where  $n_1$  is the number of continuous variables and  $p_1$  is the number of binary decisions, and dispatch variables are  $n_2$  continuous variables. We can associate these constraints to those of our formulation in Chapter 2: Constraint (3.7b) contains constraints (2.8), (2.9), (2.17), (2.19), (2.20), (2.21), Constraint (3.7c) contains (2.12), (2.13), (2.14), (2.15), (2.16), and Constraint (3.7d) contains (2.10), (2.11).

In this formulation, the second term of the objective function represents the worst case of the dispatch cost. By including this second term, we ensure that the unit commitment problem remains feasible, thus robust, under any realization of uncertainty.

Note that the dispatch constraints depend on both the unit commitment variable  $y_1$  and the uncertain parameter  $d$ . Hence, we write  $\Omega(y_1, d)$  as a feasible set defined by the dispatch constraints. We let

$\Omega(y_1, d) = \{y_2 : (3.1c), (3.1d), (3.1e) \text{ and } (3.1g) \text{ are satisfied for fixed } y_1 \text{ and } d\}$ .

Problem (3.1) can be equivalently reformulated as

$$\begin{aligned} \min_{y_1} \quad & c^T y_1 + \max_{d \in D} \min_{y_2 \in \Omega(y_1, d)} b^T y_2 \\ \text{s.t.} \quad & \text{Constraints (3.1b), (3.1f)}. \end{aligned} \tag{3.2}$$

One may observe that  $\min_{y_2 \in \Omega(y_1, d)} b^T y_2$  is actually the dispatch problem for a fixed unit commitment decision  $y_1$  and uncertain parameter  $d$ . Now, by maximizing the optimal cost of the dispatch problem over all possible  $d \in D$ , the worst case dispatch decision is obtained.

To solve Problem (3.2), we reformulate it as follows:

$$\begin{aligned} \min_{y_1, \gamma} \quad & c^T y_1 + \gamma \\ \text{s.t.} \quad & (3.1b), (3.1f) \\ & \gamma \geq S(y_1, d), \quad \forall d \in D, \end{aligned} \quad (3.3)$$

where

$$S(y_1, d) = \min_{y_2 \in \Omega(y_1, d)} b^T y_2. \quad (3.4)$$

We write  $R(y_1)$  as the worst case of the dispatch problem:

$$R(y_1) = \max_{d \in D} S(y_1, d). \quad (3.5)$$

Note that in our problem formulation, since  $R(y_1)$  represents the worst case dispatch cost, we write  $\gamma \geq 0$  without loss of optimality. This problem can be then reformulated as

$$\begin{aligned} \min_{y_1, \gamma} \quad & c^T y_1 + \gamma \\ \text{s.t.} \quad & (3.1b), (3.1f) \\ & \gamma \geq R(y_1), \\ & \gamma \geq 0. \end{aligned} \quad (3.6)$$

Problem (3.6) is solved using a Benders decomposition approach. In the following two sections, we present how to solve subproblem (3.5) and master problem (3.6).

### 3.2.1 Outer approximation to evaluate $R(y_1)$

For given  $\hat{y}_1$  and  $\hat{d}$

$$S(\hat{y}_1, \hat{d}) = \min_{y_2} \mathbf{b}^T y_2 \quad (3.7a)$$

$$\text{s.t.} \quad \mathbf{H}y_2 \leq \mathbf{h}, \quad (3.7b)$$

$$\mathbf{B}y_2 \leq -\mathbf{A}\hat{y}_1 + \mathbf{g}, \quad (3.7c)$$

$$\mathbf{E}y_2 = \hat{d}, \quad (3.7d)$$

Let  $\phi$ ,  $\lambda$  and  $\eta$  be the dual variables associated with constraints (3.7b), (3.7c) and (3.7d), respectively. Then, if we take the dual of Problem (3.7) and substitute it in Problem (3.5), we obtain

$$\begin{aligned} R(y_1) &= \max_{\lambda, \phi, \eta, d} \lambda^T (\mathbf{A}y_1 - \mathbf{g}) - \phi^T \mathbf{h} + \eta^T d \\ \text{s.t.} \quad & -\eta^T \mathbf{B} - \phi^T \mathbf{H} + \eta^T \mathbf{E} = \mathbf{b}^T \\ & \phi \geq 0, \lambda \geq 0, d \in D. \end{aligned} \quad (3.8)$$

The term  $\eta^T d$  in the objective function is a bilinear term, hence the problem is a nonlinear (nonconvex) programming problem. We first reformulate Problem (3.8) as

$$\begin{aligned} R(y_1) &= \max_{\lambda, \phi, \eta, d, \beta} \lambda^T (\mathbf{A}y_1 - \mathbf{g}) - \phi^T \mathbf{h} + \beta \\ \text{s.t.} \quad & -\eta^T \mathbf{B} - \phi^T \mathbf{H} + \eta^T \mathbf{E} = \mathbf{b}^T, \\ & \beta \leq \eta^T d, \\ & \phi \geq 0, \lambda \geq 0, d \in D. \end{aligned} \quad (3.9)$$

For a given  $\hat{y}_1$ , in order to approach  $R(\hat{y}_1)$ , using a first-order Taylor's series expansion, first define

$$L_j(\eta, d; \hat{\eta}_j, \hat{d}_j) = \hat{\eta}_j^T \hat{d}_j + (\eta - \hat{\eta}_j)^T \hat{d}_j + (d - \hat{d}_j)^T \hat{\eta}_j,$$

as a linear approximation of  $\eta^T d$  at a given point  $(\hat{\eta}_j, \hat{d}_j)$ . In an iterative approach,  $\beta \leq \eta d$  is approximated with a number of linearization  $\beta \leq L_i(\eta, d; \hat{\eta}_i, \hat{d}_i)$  for some points  $(\hat{\eta}_i, \hat{d}_i)$ ,  $i = 1, \dots, j$  generated in a systematic approach that is explained in this Section. Then one obtains an upper bound for  $R(\hat{y}_1)$  by

$$\begin{aligned} U(\hat{\eta}_j, \hat{d}_j) &= \max_{\lambda, \phi, \eta, d, \beta} \lambda^T (\mathbf{A}\hat{y}_1 - \mathbf{g}) - \phi^T \mathbf{h} + \beta \\ \text{s.t.} \quad & -\eta^T \mathbf{B} - \phi^T \mathbf{H} + \eta^T \mathbf{E} = \mathbf{b}^T \\ & \beta \leq L_i(\eta, d; \hat{\eta}_i, \hat{d}_i) \quad i = 1, \dots, j, \\ & \phi \geq 0, \lambda \geq 0. \end{aligned} \quad (3.10)$$

Also, for a given  $\hat{d} \in D$ , a lower bound can be achieved by

$$\begin{aligned} S(\hat{y}_1, \hat{d}) &= \max_{\lambda, \phi, \eta} \lambda^T (\mathbf{A}y_1 - \mathbf{g}) - \phi^T \mathbf{h} + \eta^T \hat{d} \\ \text{s.t.} \quad & -\eta^T \mathbf{B} - \phi^T \mathbf{H} + \eta^T \mathbf{E} = \mathbf{b}^T \\ & \phi \geq 0, \lambda \geq 0. \end{aligned}$$

Note that this is a LP because  $\hat{d}$  is no longer a decision variable. The solution of this problem is feasible for (3.8), hence yields a lower bound.

The steps to evaluate  $R(\hat{y}_1)$  for a given  $\hat{y}_1$  are then summarized in Algorithm 1.

- 1 **Algorithm:** Evaluate  $R(\hat{y}_1)$
- 2 Let  $j := 1$ ,  $U^{OA} = +\infty$ , and  $L^{OA} = -\infty$ . Choose a feasible  $\hat{d}_j \in D$  and a small tolerance  $\delta > 0$ .
- 3 **while**  $U^{OA} - L^{OA} > \delta$  **do**
- 4     Evaluate  $S(\hat{y}_1, \hat{d}_j)$ . Let  $(\hat{\phi}_j, \hat{\lambda}_j, \hat{\eta}_j)$  be the optimal solution.
- 5      $L^{OA} = \max\{L^{OA}, S(\hat{y}_1, \hat{d}_j)\}$ .
- 6     Define the linearization  $L_j(\eta, d; \hat{\eta}_j, \hat{d}_j)$  and update  $U(\hat{\eta}_j, \hat{d}_j)$  with it.
- 7     Evaluate  $U(\hat{\eta}_j, \hat{d}_j)$ .
- 8     Denote  $(\hat{\phi}_{j+1}, \hat{\lambda}_{j+1}, \hat{\eta}_{j+1}, \hat{\beta}_{j+1}, \hat{d}_{j+1})$  the solution.
- 9     Update  $U^{OA} = U(\hat{\eta}_j, \hat{d}_j)$ .
- 10     $j := j + 1$ .
- 11 Return  $(\hat{\phi}_j, \hat{\lambda}_j, \hat{\eta}_j, \hat{d}_j)$  as the solution and  $S(\hat{y}_1, \hat{d}_j)$  as the value.

**Algorithm 1:** Outer approximation approach to evaluate  $R(\hat{y}_1)$

Algorithm 1, called the outer approximation algorithm, is a well-known method in nonlinear and mixed-integer nonlinear programming ([17], [21], [25]). Using a Taylor's series expansion to outer approximate the nonlinear functions, a relaxed linear set is obtained for the original nonlinear feasible set. This linear set is then refined by adding further linearizations at other points generated during the course of the algorithm. Because we run this algorithm until the lower and upper bounds meet within a small tolerance  $\delta$ , the method converges to an optimal solution. However, since  $R(y_1)$  is nonconcave, only a local optimum is guaranteed. The reason why it is called an *approximation* is because



the actual nonlinear term  $\eta^T d$  is replaced with linear approximations. Note that in our case, since the problem is a maximization, optimizing the objective function over the *relaxed* linear set will yield an upper bound.

### 3.2.2 Cutting plane method to solve the master problem

Given the value of  $R(y_1)$  and a solution  $(\hat{\phi}, \hat{\lambda}, \hat{\eta}, \hat{d})$  to (3.8), the master problem of the Benders decomposition approach can be expressed as

$$\min_{y_1, \gamma} c^T y_1 + \gamma \quad (3.11a)$$

$$s.t. \quad (3.1b), (3.1f), \quad (3.11b)$$

$$\gamma \geq \hat{\lambda}_l^T (A y_1 - g) - \hat{\phi}_l^T H + \hat{\eta}_l^T \hat{d}_l \quad l = 1, \dots, i, \quad (3.11c)$$

$$\gamma \geq 0. \quad (3.11d)$$

where  $i$  is the number of iterations completed so far, and  $(\hat{\lambda}_l, \hat{\phi}_l, \hat{\eta}_l, \hat{d}_l), l = 1, \dots, i$  are the solutions of the outer approximation. Algorithm 2 summarizes steps to solve the master problem (3.3).

Constraint (3.11c) is valid as Bertsimas et al. [8] proved in their Theorem 1. Here we briefly give the proof. Given the value of  $R(y_1)$  in Problem (3.8), one has

$$\gamma \geq R(y_1) \geq \lambda^T (A y_1 - g) - \phi^T \mathbf{h} + \eta^T d$$

for all  $(\lambda, \phi, \eta, d)$  feasible to the constraints of (3.8). This implies that the inequality

$$\gamma \geq R(y_1) \geq \hat{\lambda}_l^T (A y_1 - g) - \hat{\phi}_l^T H + \hat{\eta}_l^T \hat{d}_l$$

where  $(\hat{\lambda}_l, \hat{\phi}_l, \hat{\eta}_l, \hat{d}_l)$  is a *specific* feasible solution to the constraints of (3.8). Therefore, the inequality is valid.

We should note that the master problem (3.11) is a mixed-integer linear program because  $y_1$  contains unit commitment binary variables. In Algorithm 2, we must solve this problem repeatedly, and a new branch and bound tree is constructed in each iteration. In our computational experiment over 10 instances,

- 1 **Algorithm:** Cutting plane method
- 2 Set the counter  $i = 0$ , the lower bound  $L^{BD} = -\infty$  and the upper bound  $U^{BD} = +\infty$ .
- 3 Set the convergence tolerance level  $\epsilon > 0$ .
- 4 **while**  $U^{BD} - L^{BD} > \epsilon$  **do**
- 5      $i := i + 1$ .
- 6     Solve the master problem (3.11).
- 7     Let  $(\hat{y}_1^i, \hat{\alpha}^i)$  be the optimal value.
- 8     Update the lower bound  $L^{BD} = c^T \hat{y}_1^i + \hat{\alpha}^i$ .
- 9     Evaluate  $R(\hat{y}_1^i)$  using Algorithm 1. Let  $(\phi^i, \lambda^i, \eta^i, d^i)$  be a local optimal solution.
- 10    Update the upper bound  $U^{BD} = c^T \hat{y}_1^i + R(\hat{y}_1^i)$ .

**Algorithm 2:** Cutting plane approach to solve the master problem (3.11)

the algorithm made 12 iterations on average. Note also that in each iteration a constraint (cutting plane) is added to the master problem. None of the instances were solved to within  $\epsilon$  optimality gap in 3-hour time limit on Linux machines with 8 Intel Xeon CPU E5440 2.83 GHz CPUs and 31 GB memory, using CPLEX 12.5 Python API as the MIP solver (details listed in Table 3.1). The major reason is that solving the master problem in each iteration takes too much time. In the next section, we show a remedy to overcome this drawback.

### 3.3 Branch-and-Cut Method for Solving the Robust Optimization Problem

The method presented in [8] to solve robust optimization problems has some computational weaknesses. It follows an iterative approach in which each iteration involves solving a mixed-integer program (MIP) and afterwards, having solved some subproblems, an inequality is added to the formulation. Therefore, the formulation becomes progressively larger and hence more time-consuming to solve.

Rather than solving a MIP in each iteration, we can solve the initial master problem in a single branch-and-bound tree and in each node with an integer feasible solution solve the underlying subproblems and add inequalities dynamically to the initial formulation. By employing this approach we would need to explore only one branch-and-bound tree. Hence, the method is likely to be more efficient [42]. More extensive explanation follows.

We first briefly explain the standard branch-and-bound approach to solve a mixed-integer linear program. We then show how we modify the standard approach to solve the RUC. Suppose that we want to solve the following mixed-integer linear program:

$$\begin{aligned} \min_x \quad & c^T x \\ \text{s.t.} \quad & Ax \geq b, \\ & x \in \mathbb{R}_+^{n-p} \times \mathbb{Z}_+^p \end{aligned} \tag{MIP}$$

where  $n$  is the number of variables and  $p > 0$  is the number of integer variables. The branch-and-bound method to solve (MIP) is presented in Algorithm 3. Define the feasible region of the LP relaxation problem as

$$X = \{x \in \mathbb{R}_+^n : Ax \geq b\}.$$

The LP relaxation of (MIP) is then expressed as

$$\begin{aligned} \min_x \quad & c^T x \\ \text{s.t.} \quad & x \in X. \end{aligned} \tag{Rel(X)}$$

We modify Algorithm 3 in such a way that we can solve (3.11). Algorithm 4 lists the steps of our proposed Branch-and-Cut method. As we defined the LP relaxation in (Rel(X)) for (MIP), we can introduce the LP relaxation of (3.11) by relaxing the integrality requirement of the unit commitment decisions  $y_1$ .

The main difference of the branch-and-cut Algorithm 4 from the standard branch-and-bound Algorithm 3 arises when the solution of the relaxation satisfies the integrality requirement; i.e., line 15. In that case, rather than updating

```

1 Algorithm: Branch-and-bound
2 Initialize the set of nodes:  $N = \{X\}$ .
3 Set the lower bound  $LB = -\infty$  and the upper bound  $UB = +\infty$ .
4 Let  $N = \{X\}$  be the set of nodes.
5 while  $N \neq \emptyset$  do
6     Select a node  $t$  from  $N$ .
7     Evaluate  $\text{Rel}(X_t)$ .
8     if infeasible then
9         |  $N = N \setminus \{t\}$ .
10    else
11        Let  $\hat{x}_t$  and  $\hat{z}_t$  denote the optimal solution and optimal value,
12        respectively.
13        if  $\hat{z}_t \geq UB$  then
14            | Prune the node:  $N = N \setminus \{t\}$ .
15        else if  $\hat{x}_t \in \mathbb{R}_+^{n-p} \times \mathbb{Z}_+^p$  then
16            |  $UB = \min\{UB, \hat{z}_t\}$ .
17            |  $N = N \setminus \{t\}$ .
18        else
19            Select a fractional variable  $x^r$  to branch.
20             $S_1 := X_t \cup \{x \in \mathbb{R}_+^n : x^r \leq \lfloor \hat{x}_t^r \rfloor\}$ .
21             $S_2 := X_t \cup \{x \in \mathbb{R}_+^n : x^r \geq \lceil \hat{x}_t^r \rceil\}$ .
22             $N = N \cup \{S_1, S_2\}$ .

```

**Algorithm 3:** Branch-and-bound approach to solve (MIP)

```

1 Algorithm: Branch-and-cut
2 Initialize the set of nodes:  $N = \{\}$ .
3 Set the lower bound  $LB = -\infty$  and the upper bound  $UB = +\infty$ .
4 Let  $N = \{X\}$  be the set of nodes.
5  $i = 0$ .
6 while  $N \neq \emptyset$  do
7   Select a node  $t$  from  $N$ .
8   Evaluate  $\text{Rel}(X_t)$ .
9   if infeasible then
10     $N = N \setminus \{t\}$ .
11  else
12    Let  $(\hat{y}_1^t, \hat{\gamma}^t)$  and  $\hat{z}_t$  denote the optimal solution and optimal value,
    respectively.
13    if  $\hat{z}_t \geq UB$  then
14      Prune the node:  $N = N \setminus \{t\}$ .
15    else if  $\hat{y}_1^t \in \mathbb{R}_+^{n-p} \times \{0, 1\}^p$  then
16       $i := i + 1$ .
17      Evaluate  $R(\hat{y}_1^t)$  using the Algorithm 1.
18      Let  $(\hat{\phi}_i, \hat{\lambda}_i, \hat{\eta}_i, \hat{d}_i)$  be the optimal solution.
19      if  $\hat{\gamma}^t \geq R(\hat{y}_1^t)$  then
20         $UB = \min\{UB, \hat{z}_t\}$ .
21         $N = N \setminus \{t\}$ .
22      else
23        For all  $t' \in N$ , update the  $\text{Rel}(X_{t'})$  with adding cuts
         $\gamma \geq \hat{\lambda}_i^T (Ay_1 - g) - \hat{\phi}_i^T H + \hat{\eta}_i^T \hat{d}_i$ .
24        Go to Line 8.
25      else
26        Select a fractional variable  $x^r$  to branch.
27         $S_1 := X_t \cup \{x \in \mathbb{R}_+^n : x^r \leq \lfloor \hat{x}_t^r \rfloor\}$ .
28         $S_2 := X_t \cup \{x \in \mathbb{R}_+^n : x^r \geq \lceil \hat{x}_t^r \rceil\}$ .
29         $N = N \cup \{S_1, S_2\}$ .

```

**Algorithm 4:** Branch-and-cut approach to solve robust SCUC problem

the upper bound and pruning the node, we should first check whether this solution also satisfies constraint  $\gamma \geq R(\hat{y}_1)$ . If so, the solution is accepted as a feasible solution; hence, the upper bound is updated. Otherwise, we will add an inequality (3.11c), and then solve the LP relaxation of the same node again with going back to Line 8. The rest of the algorithm is the same as the standard branch-and-bound method.

The branch-and-bound tree for Algorithm 4 has a finite number of nodes, because the formulation has only binary variables. Moreover, since the extra steps taken to process each node are the regular Benders decomposition, and the convergence of Benders decomposition is proved, the process of each node is done in finite number of iterations. Hence, this branch-and-cut algorithm converges finitely.

In our computational experiments, we implemented Algorithm 4 using the CPLEX Python API as the underlying optimization solver. The implementation consists of three main parts as follows:

- **Solving master problem (3.11).** The master problem formulation (3.11), which is a MIP problem, is defined for CPLEX using the standard approach, i.e. introducing variables, objective function and constraints to CPLEX. To solve the master problem, CPLEX then uses its own branch-and-bound approach, explained in Algorithm 3.
- **Solving subproblem (3.9).** To solve the subproblem, we implemented the outer approximation Algorithm 1. To do so, we defined the linear programming problems (3.10) (to evaluate  $U(\hat{\eta}_j, \hat{d}_j)$ ) and (3.2.1) (to evaluate  $S(\hat{y}_1, \hat{d})$ ) for CPLEX. Then, as explained in Algorithm 1, using a Python code we solve these two problems iteratively until convergence.
- **Adding cuts to the problem.** Using the solutions of Subproblem (3.9), we decide whether a cut is required to be added to the master problem or

not (Step 19 of Algorithm 4). This part was done using a `LazyConstraintCallback` through CPLEX `cutcallback`. The `LazyConstraintCallback` automatically runs a code provided by us once an integer feasible solution is obtained in a node (Step 15 of Algorithm 4). This code calls Algorithm 1, and then we check whether  $\hat{\gamma}^t \geq R(\hat{y}_1^t)$ . If not, we derive the cut and add it to the formulation.

### 3.4 Details of the Formulation

In this section, we expand the abstract formulations of  $S(y_1, d)$  and  $R(y_1)$  as well as the details of the inequality (3.11c). The notations have been previously introduced in Section 2.2.

$$\begin{aligned}
S(y_1, d) = & \max_{\lambda, \phi, \eta} \sum_{k \in K} \sum_{j \in \mathcal{G}} \lambda_{jk}^1 P_j v_j(k) + \sum_{k \in K} \sum_{j \in \mathcal{G}} \lambda_{jk}^2 \bar{P}_j v_j(k) + \sum_{j \in \mathcal{G}} \lambda_{j1}^3 (SU_j - \bar{P}_j) v_j(1) \\
& + \sum_{k \in K \setminus \{1\}} \sum_{j \in \mathcal{G}} \lambda_{jk}^3 [(RU_j - SU_j) v_j(k-1) + (SU_j - \bar{P}_j) v_j(k)] \\
& + \sum_{k=1}^{|K|-1} \sum_{j \in \mathcal{G}} \lambda_{jk}^4 [SD_j v_j(k) + (\bar{P}_j - SD_j) v_j(k+1)] + \sum_{j \in \mathcal{G}} \lambda_{j1}^5 (RD_j - SD_j) v_j(1) \\
& + \sum_{k=2}^{|K|} \sum_{j \in \mathcal{G}} \lambda_{jk}^5 [(RD_j - SD_j) v_j(k) + (SD_j - \bar{P}_j) v_j(k-1)] - \sum_{k \in K} \sum_{j \in \mathcal{G}} \lambda_{jk}^6 a_j v_j(k) \\
& + \sum_{k \in K} \eta_k^2 \left( \sum_{b \in B} d(b, k) \right) + \sum_{b \in B} \sum_{k \in K} \eta_{bk} (d(b, k)) \\
& \text{s.t. } (\phi, \lambda, \eta) \in \Gamma(d)
\end{aligned}$$

where

$$\begin{aligned}
 & \sum_{j \in \mathcal{G}(b)} (1 - \rho_j(k)) \eta_{bk} + \lambda_{jk}^1 - \phi_{jk}^6 + \lambda_{j,k+1}^3 + \lambda_{jk}^5 - \lambda_{j,k+1}^5 \\
 & -b_j \lambda_{jk}^6 - \phi_{jk}^7 \leq 0, \quad \forall j, k = 2, \dots, |K| - 1 \\
 & \sum_{j \in \mathcal{G}(b)} (1 - \rho_j(k)) \eta_{bk} + \lambda_{jk}^1 - \phi_{jk}^6 + \lambda_{j,k+1}^3 + \lambda_{jk}^5 - \lambda_{j,k+1}^5 \\
 & -b_j \lambda_{jk}^6 - \phi_{jk}^7 \leq 0, \quad \forall j, k = 1 \\
 & \sum_{j \in \mathcal{G}(b)} (1 - \rho_j(k)) \eta_{bk} + \lambda_{jk}^1 - \phi_{jk}^6 + \lambda_{jk}^5 \\
 & -b_j \lambda_{jk}^6 - \phi_{jk}^7 \leq 0, \quad \forall j, k = |K| \\
 & \eta_k^2 + \phi_{jk}^6 - \lambda_{jk}^2 - \lambda_{jk}^3 - \lambda_{jk}^4 - \phi_{jk}^8 \leq 0, \quad \forall j, k = 1, \dots, |K| - 1 \\
 & \eta_k^2 + \phi_{jk}^6 - \lambda_{jk}^2 - \lambda_{jk}^3 - \phi_{jk}^8 \leq 0, \quad \forall j, k = |K| \\
 \Gamma(d) = & \left\{ (\phi, \lambda, \eta) : \sum_{\ell: BF(\ell)=1} B(\ell) \phi_{\ell k}^1 + \sum_{\ell: BT(\ell)=1} B(\ell) \phi_{\ell k}^1 + \phi_k^2 + \phi_{1k}^{11} + \phi_{1k}^{12} = 0, \quad \forall k \right. \\
 & \sum_{\ell: BF(\ell)=b} B(\ell) \phi_{\ell k}^1 + \sum_{\ell: BT(\ell)=b} B(\ell) \phi_{\ell k}^1 + \phi_{bk}^{11} + \phi_{bk}^{12} = 0, \quad \forall k, \forall b \geq 2 \\
 & \phi_{\ell k}^1 - \eta_{\ell: BF(\ell), k} - \eta_{BT(\ell), k} + \phi_{\ell k}^9 - \phi_{\ell k}^{10} = 0, \quad \forall \ell, k \\
 & \lambda_{jk}^6 \leq 1, \quad \forall j, k \\
 & \eta_{bk} + \phi_{bk}^3 = 0, \quad \forall b, k \\
 & \phi_k^4 + \eta_k^2 = 0, \quad \forall k \\
 & -\phi_{bk}^3 \leq \Lambda_1, \quad \forall b, k \\
 & \phi_{bk}^3 \leq \Lambda_2, \quad \forall b, k \\
 & -\phi_{bk}^4 \leq \Lambda_1, \quad \forall k \\
 & \left. \phi_k^4 \leq \Lambda_2, \quad \forall k \right\},
 \end{aligned}$$



and  $\lambda^1, \lambda^2, \lambda^3, \lambda^4, \lambda^5, \lambda^6, \eta, \eta^2, \phi^7, \phi^8, \phi^8, \phi^9, \phi^{10}, \phi^{11}$  and  $\phi^{12}$  are the dual variables associated with the constraints of the dispatch problem.

By this result,  $R(y_1)$  can be written as

$$\begin{aligned}
R(y_1) = & \max_{\lambda, \phi, \eta, d} \sum_{k \in K} \sum_{j \in \mathcal{G}} \lambda_{jk}^1 P_j v_j(k) + \sum_{k \in K} \sum_{j \in \mathcal{G}} \lambda_{jk}^2 \bar{P}_j v_j(k) + \sum_{j \in \mathcal{G}} \lambda_{j1}^3 (SU_j - \bar{P}_j) v_j(1) \\
& + \sum_{k \in K \setminus \{1\}} \sum_{j \in \mathcal{G}} \lambda_{jk}^3 [(RU_j - SU_j) v_j(k-1) + (SU_j - \bar{P}_j) v_j(k)] \\
& + \sum_{k=1}^{|K|-1} \sum_{j \in \mathcal{G}} \lambda_{jk}^4 [SD_j v_j(k) + (\bar{P}_j - SD_j) v_j(k+1)] + \sum_{j \in \mathcal{G}} \lambda_{j1}^5 (RD_j - SD_j) v_j(1) \\
& + \sum_{k=2}^{|K|} \sum_{j \in \mathcal{G}} \lambda_{jk}^5 [(RD_j - SD_j) v_j(k) + (SD_j - \bar{P}_j) v_j(k-1)] - \sum_{k \in K} \sum_{j \in \mathcal{G}} \lambda_{jk}^6 a_j v_j(k) \\
& + \sum_{k \in K} \eta_k^2 (\sum_{b \in B} d(b, k)) + \sum_{b \in B} \sum_{k \in K} \eta_{bk} (d(b, k)) \\
& s.t. \quad (\phi, \lambda, \eta) \in \Gamma(d) \qquad \qquad \qquad \forall d \in D.
\end{aligned}$$

The expanded inequality (3.11c) in our formulation is the following:

$$\begin{aligned}
& \gamma - \sum_{k \in K} \sum_{j \in \mathcal{G}} \hat{\lambda}_{jk}^1 P_j v_j(k) + \sum_{k \in K} \sum_{j \in \mathcal{G}} \hat{\lambda}_{jk}^2 \bar{P}_j v_j(k) + \sum_{j \in \mathcal{G}} \hat{\lambda}_{j1}^3 (SU_j - \bar{P}_j) v_j(1) \\
& + \sum_{k \in K \setminus \{1\}} \sum_{j \in \mathcal{G}} \hat{\lambda}_{jk}^3 [(RU_j - SU_j) v_j(k-1) + (SU_j - \bar{P}_j) v_j(k)] \\
& + \sum_{k=1}^{|K|-1} \sum_{j \in \mathcal{G}} \hat{\lambda}_{jk}^4 [SD_j v_j(k) + (\bar{P}_j - SD_j) v_j(k+1)] + \sum_{j \in \mathcal{G}} \hat{\lambda}_{j1}^5 (RD_j - SD_j) v_j(1) \\
& + \sum_{k=2}^{|K|} \sum_{j \in \mathcal{G}} \hat{\lambda}_{jk}^5 [(RD_j - SD_j) v_j(k) + (SD_j - \bar{P}_j) v_j(k-1)] - \sum_{k \in K} \sum_{j \in \mathcal{G}} \hat{\lambda}_{jk}^6 a_j v_j(k) \\
& \geq
\end{aligned}$$

$$\begin{aligned}
& + \sum_{k \in K} \sum_{j \in \mathcal{G}} \hat{\lambda}_{j1}^3 [(SU_j - RU_j)v_j(0) - \bar{P}_j - P_j(0)] - \sum_{k=2}^{|K|} \sum_{j \in \mathcal{G}} \hat{\lambda}_{jk}^3 \bar{P}_j \\
& + \sum_{j \in \mathcal{G}} \hat{\lambda}_{j1}^5 [(\bar{P}_j - SD_j)v_j(0) - \bar{P}_j + P_j(0)] - \sum_{k=2}^{|K|} \sum_{j \in \mathcal{G}} \hat{\lambda}_{jk}^5 \bar{P}_j \\
& + \sum_{k \in K} \sum_{b \in \mathcal{B}} (\hat{\eta}_{bk} + \hat{\eta}_{k}^2) \hat{D}(b, k) - \sum_{k \in K} \sum_{j \in \mathcal{G}} (\hat{\phi}_{jk}^7 + \hat{\phi}_{jk}^8) \bar{P}_j \\
& - \sum_{l \in \mathcal{L}} \sum_{j \in \mathcal{G}} TL(l) (\hat{\phi}_{lk}^9 + \hat{\phi}_{lk}^{10}) - \sum_{k \in K} \sum_{b \in \mathcal{B}} \pi (\hat{\phi}_{bk}^{11} + \hat{\phi}_{bk}^{12}),
\end{aligned}$$

where  $\hat{\lambda}^1, \hat{\lambda}^2, \hat{\lambda}^3, \hat{\lambda}^4, \hat{\lambda}^5, \hat{\lambda}^6, \hat{\eta}, \hat{\eta}^2, \hat{\phi}^7, \hat{\phi}^8, \hat{\phi}^9, \hat{\phi}^{10}, \hat{\phi}^{11}, \hat{\phi}^{12}$  and  $\hat{D}$  are the output of solving  $R(y_1)$ .

### 3.5 Computational Results

We tested the efficiency of the branch-and-cut algorithm with the same test instances solved in Chapter 2. This is the IEEE RTS-96 data set [74] which is modified to a test case with 24 buses and 32 generators, and 38 transmission lines. In addition, 3 wind farms are accommodated to the data set. The repository of this data set is located at [4]. Two types of uncertainty sets were constructed as described in Chapter 2.

We implemented both algorithms in Python 2.7 and employed CPLEX 12.5 as the integer programming solver. All tests were done on Linux machines with 8 Intel Xeon CPU E5440 2.83 GHz CPUs and 31 GB memory, using CPLEX 12.5 Python API as the MIP solver. For the time limit, we allowed 3 hours for both of the methods.

In order to verify the correctness of the implementation, we compared the solution of the cutting plane method with our proposed branch-and-cut method. However, the cutting plane method was not able to solve our original test instances. Therefore, we chose to do the verifications on a test instance with 4 buses, and 5 generators with 10 scenarios so that the cutting plane converged to the optimal solution within time limit. For different parameter settings, the

solutions of the cutting plane method matched with those of our branch-and-cut method.

Table 3.1 summarizes computational results of the Benders decomposition based algorithm proposed in [8] and the adopted branch-and-cut approach for this Benders decomposition. In this table  $\Lambda_1$  and  $\Lambda_2$ , as explained in Section 2.2, are the penalty weights for non-zero slack and surplus variables, respectively. We computed the gaps for cutting plane approach by

$$\text{Gap}\% = \frac{UBD - LBD}{UBD} \times 100.$$

Table 3.1: Comparison of the proposed branch-and-cut method with the existing cutting plane approach of [8] on instances with different settings. The columns show CPU time in seconds, number of iterations and % gap for the cutting plane approach, and CPU time in seconds and % gap for the branch-and-cut. A "-" means the instance solved to optimality.

	$\Lambda_1$	$\Lambda_2$	Cutting plane [8]			Branch-and-cut		
			T(s)	Iter.	G(%)	T(s)	G(%)	
RUC- $\mathcal{U}_1$	$\Delta = 0.1 N_d $	20	1	10800	17	4.65	1044.2	-
	$\Delta = 0.2 N_d $	20	1.0	10800	12	5.14	1118.7	-
	$\Delta = 1.0 N_d $	20	1.0	10800	16	2.06	498.8	-
	$\Delta = 0.2 N_d $	10	0.1	10800	9	7.24	2059.0	-
	$\Delta = 0.2 N_d $	40	10	10800	4	14.29	2168.3	-
RUC- $\mathcal{U}_1$	$\alpha = 0.1$	20	1	10800	7	5.31	404.1	-
	$\alpha = 0.2$	20	1.0	10800	10	3.31	411.0	-
	$\alpha = 0.5$	20	1.0	10800	14	4.10	637.5	-
	$\alpha = 0.5$	10	0.1	10800	11	7.13	1591.7	-
	$\alpha = 0.5$	40	10	10800	12	8.43	2950.4	-

Results show that the cutting plane was not able to solve any of the instances to optimality within the 3 hour time limit whereas the branch-and-cut method solved all the instances in much less time than allowed. The proposed method found the optimal solution for all but one of 10 instances in less than 40 minutes. We also observed that decrements of the gap in the cutting plane approach slow down as the algorithm progresses. This implies that one should expect a much longer time to close the gap with cutting plane approach.

### 3.6 Conclusions

In this chapter, we adopted a branch-and-cut approach to solve the Benders decomposition algorithm for a robust optimization formulation of the unit commitment problem. Being able to solve this problem in short amount of time in a daily basis is one of the challenges of system operators.

The drawback of the existing algorithm is that it requires solving a mixed-integer programming (MIP) problem in each iteration while this problem becomes larger during the course of the algorithm. As solving a MIP is computationally hard, this approach typically does not converge even for small sized instances, hence cannot be a good option for solving real-world problems.

The adopted branch-and-cut scheme overcomes this drawback by solving only one branch-and-bound tree and dynamically adding linear inequalities to eliminate infeasible solutions and refine the feasible region within that branch-and-bound procedure. The proposed approach dramatically improves the solution time for the instance that we considered. As a future step, we intend to conduct testing on other instances including those with larger numbers of buses and generators. In this way, we will ensure the method is robust and reliable.

Another possible test plan of the method is to compare the results of the idea presented in Algorithm 4 with that proposed by Bertsimas et al. [8] on the more efficient integer mixed-integer formulation presented in [39].

## CHAPTER 4. AN APPROXIMATION FOR CVAR OF ELECTRIC POWER PRODUCTION COST CONSIDERING GENERATING UNIT FAILURES

### 4.1 Introduction

Reliability is a primary concern in power grid operations. Unexpected outages of power grid elements, such as transmission lines and generators, can result in dramatic electricity shortage. Uncertain outages of equipments, like other uncertain parameters in power grid operations, were traditionally managed by considering operating reserve requirements [68]. Alternate approaches that allow the explicit modeling of the sources of uncertainty include stochastic programming [55] and robust optimization [5, 60, 72]. Distributionally robust optimization (DRO) is a moderately data-driven approach in which the true distribution of a random variable is unknown and assumed to lie within a confidence set. An example of applying the DRO framework for the unit commitment problem with supply uncertainty considering random outages can be found in [23].

Uncertain failures may include extremely rare events which lead to very costly decisions. This concern can be addressed by considering and evaluating the risk associated with the solutions. Imposing risk measures is a common way to incorporate risk-averse preferences in the decisions. Several different risk measures have been used in the literature. Considering expected value and variance of the total profit or a certain quantity associated with a set of UC decisions is a basic idea of managing risk. However, the most widely used

risk measure is Loss of Load Probability (LOLP) which can be formulated in terms of chance constraints. These constraints enforce a requirement that the probability that the total dispatch subject to random outages is greater than or equal to the random net load/demand at that time period. To ensure system reliability, constraints restricting this risk measure for all time periods based on a specified confidence level are added to the problem. Some examples of using chance constraints assuming the presence of random outages are [70, 71] in which uncertain wind power and demand are considered, and [10, 14] which consider probabilistic reserve criterion. Chance constraints restricting LOLP are equivalent to restricting the Value at Risk (VaR) of the random loss of load associated with a specified upper tail probability. However, VaR is not a coherent risk measure as it does not satisfy the subadditivity property for general probability distributions. Instead, another risk measure, Conditional Value at Risk (CVaR), is more favored, because it is coherent and computationally tractable [50, 51]. An example of using CVaR to formulate an optimization model with random outages is [47] in which wind and demand uncertainty are assumed.

Considering uncertain outages of power grid elements involves a large number of scenarios, for each of which a binary variable needs to be introduced, with 0 and 1 representing if a scenario will be selected or not. Some studies consider all possible component failure scenarios such as [5, 55, 60, 72]. However, enumeration of a large set of failure scenarios requires significant computational effort. Hence, most papers addressing this issue enumerate a given set of components as candidates for possible failures [10, 26, 68]. Besides a large number of binary variables indicating random outages, models considering chance constraints also contain additional binary variables to formulate this risk measure. This makes these models computationally difficult even with a limited number of scenarios. Therefore, in addition to methods considering a set of possible outages (e.g., [10]), other approximation methods using exponential functions

(e.g., [14]) or Sample Average Approximation (e.g., [70, 71]) have been also used for chance-constrained models.

Different solution algorithms such as Benders decomposition [68] and primal and dual decomposition [72] have been used for models considering uncertain outages of power grid components. Some other solution algorithms including meta heuristic algorithms have been also used to mitigate the computational difficulty of such problems. For example, a genetic algorithm is proposed to find a feasible status of units in order to reduce the risk of unavailability of the committed units and simultaneously satisfy several constraints such as ramp rate, minimum up and down time [29]. Another genetic algorithm framework is presented in [48] for a model with different sources of uncertainties such as load, wind and solar generation and generator outages. An evolutionary algorithms is used in [22] to solve power generating unit commitment problems with probabilistic unit outages. Finally, a particle swarm optimization is developed to locate the optimum generation combination for a UC model considering generator outages, where the reliability requirement is incorporated into the spinning reserve constraint [69].

Because considering random outages in power systems operations involves enumeration of a large set of possible failure scenarios and, therefore, requires additional computational effort, much research has been done to find more efficient formulations and solution procedures. However, it is crucial to be able to analyze the reliability of power systems in a reasonable time period. Hence, it is worth investigating approximation approaches that do not require enumeration of all or a set of possible failure scenarios.

The aim of this chapter is to present an efficient and time-saving approach for evaluating the risk associated with the power system. Among different risk measures, CVaR is attractive because it is coherent and also provides information about the related VaR and LOLP because of the CVaR is defined upon VaR [50, 51]. However, it is difficult to compute CVaR by solving a stochas-

tic program along with the huge number of scenarios that would be added to address contingencies. Generally, it takes more scenarios to estimate CVaR, because it deals with the tail of the distribution. An alternative approach is to apply a renewal reward process to asymptotically approximate CVaR as was done to approximate cost variance [56].

In this study, we estimate the CVaR of electric power production cost over a specified time. Assuming a given set of committed units, under simplifying assumptions, we apply a renewal reward process, an asymptotic central limit theorem and the definition of CVaR for the normal distribution to achieve this approximation. In probability theory, a renewal process is a counting process for which the times between successive events are independent and identically distributed with an arbitrary distribution [52]. Let  $N(t), t \geq 0$ , be a counting process and let  $X_n$  denote the time between the  $(n - 1)$ st and the  $n$ th event of this process,  $n \geq 1$ . If the sequence of nonnegative random variables  $X_1, X_2, \dots$  is independent and identically distributed, then the counting process  $N(t), t \geq 0$ , is a renewal process. If we denote a random reward earned at the time of the  $n$ th renewal by  $R_n$ , then the total reward earned by time  $t$  is represented by

$$R(t) = \sum_{n=1}^{N(t)} R_n.$$

Assume that  $\Gamma(t)$  represents the total reward up to time  $t$  experienced by a renewal process with interrenewal time  $T$  and reward per renewal  $Z$ . Smith [59] showed that the cumulative reward is asymptotically normal and Brown and Solomon [11] showed that the variance of  $\Gamma(t)$  is given by



$$\text{Var}[\Gamma(t)] = at + b + o(1)$$

where

$$a = \tau_2 \theta_1^2 / \tau_1^3 - 2\eta_{11} \theta_1 / \tau_1^2 + \theta_2 / \tau_1,$$

and

$$\tau_1 = E(T), \tau_2 = E(T^2), \theta_1 = E(Z), \theta_2 = E(Z^2), \eta_{11} = E(ZT).$$

This justifies the use of normal formulations to compute the CVaR of the cost in this study.

Many applications of renewal theory involve costs which can be simply seen as a negative reward. In the next section, we explain the application of this theory in asymptotically approximating of the variance of the cost of electric power system with random failure and repair times for the generating units.

## 4.2 Problem Statement

Security of a power system refers to its ability to survive contingencies, while avoiding any undesirable disruption of service. The concept of N-1 security assessment has been developed to quantify security. It is a standard enforced by the North American Electric Reliability Corporation (NERC). In this study, we consider the system to be in a N-1 secure state. In other words, the system is able to operate with one component failure. The N-1 security standard reflects the low probability that unscheduled outages of more than one component would occur at the same time.

Assume that  $N$  generating units have been committed for a specified time horizon. Unit  $i$  has capacity  $c_i$  (in MW) and variable operating cost  $d_i$  (in \$/MW h), with  $d_1 \leq d_2 \leq \dots \leq d_N$ . The load on the system at any time is satisfied by the least expensive set of units available, and, in case insufficient capacity is available to satisfy the load, the cost of any unmet demand is given

by  $d_{N+1} > d_N$ . Let  $A_i(s)$  be the operating state of unit  $i$  at time  $s$ , so that  $A_i(s) = 1$  if unit  $i$  is available and 0 otherwise. Assume that the operating state of each unit follows a stationary continuous Markov chain with a failure rate  $\lambda_i$  and repair rate  $\mu_i$  per hour. The ratio  $p_i = \lambda_i/(\lambda_i + \mu_i)$  represents the proportion of time during which unit  $i$  is not available.

In relation to the previous chapters, we are simplifying here by ignoring ramping, minimum up and down-time, and transmission constraints. Therefore, this approximation considers only failures of generating units. One major and one minor simplifying assumption are also considered for the approximation. First, at most one generating unit is unavailable at any point in time which is consistent with the N-1 security criterion; Second, the times when failures occur and units are returned to service coincide with the beginning of a load cycle. By the first assumption, the state of the system,  $[A_1(s), A_2(s), \dots, A_N(s)]$  at time  $s$ , can be described as a renewal process. We suppose all units are available at time 0, and after a random time,  $X$ , one unit fails. On basis of the first assumption, no other failure occurs during this failure time,  $Y$ . The time  $T = X + Y$  then represents the time when the failed unit is restored to service and follows a renewal process. Denote the total production cost during  $T$  by  $Z = U + V$  where  $U$  is the cost during  $X$  and  $V$  is the cost during  $Y$ . The second assumption simplifies the estimation of the costs  $U$  and  $V$ .

According to the second assumption, the time to failure,  $X$ , consists of a number,  $K$ , of load cycles plus a remainder,  $R$ . Assuming  $\Delta$  as the length of each load cycle, we have:  $X = K\Delta + R$ . Similarly, for a random unit  $J = j$ , the unit down time can be written as  $Y = K_j\Delta + R_j$ , where  $K_j$  and  $R_j$  have distributions similar to  $K$  and  $R$ , respectively.

Ryan [56] developed formulas to compute the slope,  $a$ , of the asymptotic variance. The intercept,  $b$ , is a function of moments up to the third order, and will not be used. The expected production cost,  $E[\Gamma(t)]$ , is approximated as  $(\theta_1/\tau_1)t$ . We will use this  $\mu$  as the expected value in future computations.

Variables  $X$  and  $Y$  are independent and follow exponential distributions with rate  $\Lambda = \sum_j \lambda_j$  and  $M$ , respectively, where  $M = \mu_j$  with probability  $\lambda_j/\Lambda$ . Considering  $J$  as the index of the unit that fails, we have  $J = j$  with probability  $\lambda_j/\Lambda$ . Thus, the quantities  $\tau_1$  and  $\tau_2$  can be computed as follows.

$$\tau_1 = E(T) = E(X) + E(Y),$$

where

$$E(X) = 1/\Lambda,$$

and

$$E(Y) = E_J[E(Y|J)] = \sum_j \frac{\lambda_j}{\mu_j \Lambda}.$$

$$\tau_2 = E(T^2) = E[(X + Y)^2] = E(X^2) + 2E(X)E(Y) + E(Y^2),$$

where

$$E(X^2) = 2/\Lambda,$$

and

$$E(Y^2) = E_J[E(Y^2|J)] = \sum_j \frac{2\lambda_j}{\mu_j^2 \Lambda}.$$

To evaluate the parameters involving  $Z = U + V$  note that  $U$  depends on  $X$ , whereas  $V$  depends on  $Y$ . According to the second assumption, the time to failure,  $X$ , can be written as  $X = K\Delta + R$  where  $K$  has a geometric distribution with parameter  $1 - e^{-\Lambda\Delta}$ , and  $R$  is distributed according to the truncated exponential density function

$$f(r) = \Lambda e^{-\Lambda r} / (1 - e^{-\Lambda\Delta}), \quad \text{for } 0 < r < \Delta.$$

Given  $J = j$ , the time to repair,  $Y$ , can be also written as  $Y = K_j\Delta + R_j$ , where  $K_j$  and  $R_j$  have distributions similar to  $K$  and  $R$ , respectively, with  $\Lambda$  replaced by  $\mu_j$ .

Parameters  $\theta_1$ ,  $\theta_2$  and  $\eta_{11}$  which involve moments of  $Z$  can be computed as listed below. We refer to [56] for more details on these formulations.

$$\theta_1 = E(Z) = E(U) + E(V).$$

$$\theta_2 = E(Z^2) = Var(Z) + [E(Z)]^2,$$

where

$$Var(Z) = Var(U) + Var(V)$$

and

$$Var(U) = E + X[Var(U|X)] + Var_X[E(U|X)]$$

$$Var(V) = E_J[Var(V|J)] + Var_J[E(V|J)].$$

The conditional values are computed as

$$E_J [Var(V|J)] = \sum_j \frac{\lambda_j}{\Lambda} \left( Var(K_J) \left[ \int_0^{\Delta} v_j(t) dt \right]^2 + Var \left[ \int_0^{R_j} v(t) dt \right] \right)$$

$$Var_J [E(V|J)] = \sum_j \frac{\lambda_j}{\Lambda} [E(V|J = j)]^2 - \left[ \sum_j \frac{\lambda_j}{\Lambda} E(V|J = j) \right]^2 ,$$

$$E [V|J = j] = E[K_j] \int_0^{\Delta} v_j(t) dt + E \left[ \int_0^{R_j} v_j(t) dt \right] .$$

Finally,

$$\eta_{11} = E(ZT) = E(UX) + E(V)E(X) + E(U)E(Y) + E(VY).$$

Here,  $u(s)$  is the production cost at time  $s$  with all units available,  $v_j(s)$  is the cost at time  $s$  with unit  $j$  unavailable, and  $\Lambda$  is the parameter of the

distributions of  $K_j$  and  $R_j$ . The expectations involving integrals with random upper limits ( $R$  or  $R_j$ ) are approximated numerically.

According to the Central Limit Theorem (CLT), the sum of a large number of rewards approximately follows a normal distribution. Therefore, the accumulative generation costs over long period of time would approximately follow a normal distribution. This intuition is formalized in a central limit theorem presented in [59].

The CVaR formulations defined for a normal distribution can be used to approximate CVaR. Assuming a random variable  $G$  follows a normal distribution,  $G \sim \text{Normal}(\mu, \sigma^2)$ , its CVaR is given by the following formula [79]:

$$\text{CVaR}^{(\alpha)}(G) = \mu + k(\alpha)\sigma$$

where

$$k(\alpha) = \frac{\exp(-(\Phi^{-1}(\alpha))^2/2)}{\alpha}$$

where  $\Phi(z)$  is the standard normal distribution function.

In summary, we employ an asymptotic approximation that results from a CLT for cumulative rewards. We also consider simplifying assumptions to use a renewal reward model to approximate the expected value and variance of the cost. Therefore, the above relations can be used as an approximation of CVaR of the total production cost with respect to generating unit failures.

### 4.3 Numerical Experiment

The proposed asymptotic approximation has been tested by the modified IEEE RTS-96 system [74] with 96 generators using data from [4]. The data set includes hourly demand data for one year. We considered the average of

load scenarios for each hour in a day over the whole year, and set the sum of loads over all buses as the total load for each hour. The production cost is considered as the average of stepwise production costs for each generators, and the cost of unmet demand is considered as 100 \$/MWh. There are 19 wind farms accommodated to the grid as in [44] with wind scenarios extracted from the NREL wind data sets [3]. We selected 19 renewable generation data randomly from this data set and computed net load for each hour as the difference between load and the output of renewable generation.

We tested a subset of generators which are committed based on the solution from optimization problem without constraints on ramping, minimum up and down-time, and transmission lines. This set consists of 47 generators out of 96 generators. Tables 4.1 and 4.2 contains generating unit data and sequence of load levels for this example respectively.

In order to evaluate the quality of the proposed asymptotic approximation, we compared the approximated results with the results from simulation. Our approach is to simulate outages and dispatch over all hours in the horizon and compute cumulative costs over the horizon and calculate CVaR of the cost directly from simulated costs. Algorithm 5 shows the pseudocode for the simulation of CVaR of the cost. In implementing the simulation, we consider  $bigreps = 1000$  and  $reps = 100$ .

In the pseudocode presented in Algorithm 5, when we simulated the *FailedUnits* array, we calculated the cost of satisfying the required loads in each hour given the failed units of the associated hour. Note that when an entry in the *FailedUnits* array is 0, it implies that all units are available. We insert 0 for the time that the next failure time is generated, because we assumed that in each period at most one unit could fail. Hence, until the next failure time there will be no failed units. Once we have the cost for all *reps* inner loops, we can calculate the VaR and CVaR for 95th percentile of each outer loop with given relations for VaR and CVaR.

Table 4.1: Generating unit data for unconstrained committed set of generators of IEEE RTS-96 test system

Unit $i$	Capacity $c_i$ (MW)	Forced outage rate $p_i$	$MTTF$ $1/\lambda_i$ (h)	$MTTR$ $1/\mu_i$ (h)	Cost $d_i$ (\$/MWh)
1	400	0.12	1100	150	7.33
2	400	0.12	1100	150	7.34
3	197	0.05	950	50	17.71
4	197	0.05	950	50	17.72
5	197	0.05	950	50	17.73
6	197	0.05	950	50	17.81
7	197	0.05	950	50	17.82
8	197	0.05	950	50	17.83
9	197	0.05	950	50	17.91
10	197	0.05	950	50	17.92
11	100	0.04	1200	50	18.38
12	100	0.04	1200	50	18.39
13	100	0.04	1200	50	18.47
14	100	0.04	1200	50	18.48
15	76	0.02	1960	40	19.34
16	76	0.02	1960	40	19.35
17	76	0.02	1960	40	19.45
18	76	0.02	1960	40	19.46
19	155	0.04	960	40	24.53
20	155	0.04	960	40	24.54
21	155	0.04	960	40	24.61
22	155	0.04	960	40	24.62
23	155	0.04	960	40	24.63
24	155	0.04	960	40	24.64
25	155	0.04	960	40	24.71
26	155	0.04	960	40	24.72
27	20	0.1	450	50	29.27
28	20	0.1	450	50	29.28
29	20	0.1	450	50	29.29
30	20	0.1	450	50	29.30
31	50	0.01	1980	20	29.38
32	20	0.1	450	50	29.38
33	20	0.1	450	50	29.47
34	50	0.01	1980	20	29.48
35	20	0.1	450	50	29.48
36	20	0.1	450	50	29.49
37	20	0.1	450	50	29.50
38	50	0.01	1980	20	29.54
39	50	0.01	1980	20	29.55
40	50	0.01	1980	20	29.56
41	12	0.02	2940	60	30.16
42	12	0.02	2940	60	30.16
43	12	0.02	2940	60	30.17
44	12	0.02	2940	60	30.24
45	12	0.02	2940	60	30.36
46	12	0.02	2940	60	30.36
47	12	0.02	2940	60	30.37

Table 4.2: Sequence of load levels over a 24-hour cycle for IEEE RTS-96 test system

Hour	Load (MW)	Hour	Load (MW)	Hour	Load (MW)
1	5228	9	7258	17	7671
2	4863	10	7422	18	7876
3	4618	11	7466	19	7873
4	4538	12	7443	20	7557
5	4524	13	7424	21	7158
6	4620	14	7380	22	6560
7	5601	15	7191	23	5796
8	6496	16	7250	24	5019

```

1 Algorithm: Run Simulation
2 Let bigreps and reps be the number of iterations.
3 Let T be the simulation time.
4 for i = 1 to bigreps do
5   for k = 1 to reps do
6     Let clock = 0.
7     Let FailedUnits = [0, 0, ..., 0]T.
8     while clock ≤ T do
9       Generate a random variate from an exponential distribution
10      with parameter  $\Lambda = \sum_j \lambda_j$  and call it f as the next failure
11      time.
12      Pick the failing unit  $\tilde{j}$  with probability  $\lambda_j/\Lambda, j = 1, \dots, M$ .
13      Update FailedUnits(l) = 0 for l = clock + 1, ..., clock + f.
14      clock := clock + f.
15      Generate a random variate from an exponential distribution
16      with parameter  $\mu_{\tilde{j}}$  and call it r as the next repair time.
17      Update FailedUnits(l) =  $\tilde{j}$  for l = clock + 1, ..., clock + r.
18      clock := clock + r.
19     Calculate cost of iteration j given FailedUnits.
20   Sort costs over the reps data and find  $\mathbf{VaR}_i$  = 95th percentile over
21   the reps data values.
22   Compute the  $\mathbf{CVaR}_i$  as the mean of the costs that exceeds  $\mathbf{VaR}_i$ 
23   over the reps data values.

```

**Algorithm 5:** Pseudocode for the simulation



The formula for the asymptotic approximation and simulation were implemented in Matlab. In Table 4.3, the value of the CVaR of the cost obtained from the proposed asymptotic approximation for different time horizons is compared with its value found by simulation. The gap for CVaR of the cost is computed by

$$\text{Gap\%} = \frac{\text{Approximated CVaR} - \text{Simulated CVaR}}{\text{Simulated CVaR}} \times 100.$$

The gap between the approximated CVaR and the simulated CVaR decreases as the time horizon increases. The respective CPU-times are also shown in Table 4.3. The approximation runs much faster compared to the simulation. This approximation can provide a tool to approximate the risk associated with the existing commitment in long term.

In order to investigate impact of ignoring unit commitment and ramping constraints, we consider a different set of generators which is obtained from UC optimization model considering these constraints. This set consists of 49 generators out of 96 which are commuted to satisfy the load in the constrained UC problem. Tables 4.1 contains generating unit data for constrained set of generators.

Table 4.3: Comparison of the CVaR approximation with simulation (CI stands for 95% confidence interval half-width for the simulated CVaR)

	24 Hours	168 Hours	672 Hour	2016 Hours
Mean from approximation	$6.12 \times 10^6$	$4.35 \times 10^7$	$1.74 \times 10^8$	$5.22 \times 10^8$
Variance from approximation	$5.49 \times 10^{12}$	$3.84 \times 10^{13}$	$1.54 \times 10^{14}$	$4.61 \times 10^{14}$
CVaR from approximation	$1.83 \times 10^7$	$7.55 \times 10^7$	$2.38 \times 10^8$	$6.33 \times 10^8$
CVaR from simulation	$6.59 \times 10^6$	$4.72 \times 10^7$	$1.87 \times 10^8$	$5.48 \times 10^8$
CI for the simulated CVaR	$4.05 \times 10^3$	$4.45 \times 10^4$	$1.15 \times 10^5$	$1.80 \times 10^5$
Gap ( %)	178.28	60.20	27.60	15.44
Simulation CPU Time (s)	39.96	119.16	419.50	1337.67
Approximation CPU Time (s)	0.06	0.06	0.06	0.06

Table 4.4: Generating unit data for constrained committed set of generators of IEEE RTS-96 test system

Unit $i$	Capacity $c_i$ (MW)	Forced outage rate $p_i$	$MTTF$ $1/\lambda_i$ (h)	$MTTR$ $1/\mu_i$ (h)	Cost $d_i$ (\$/MWh)
1	400	0.12	1100	150	7.33
2	400	0.12	1100	150	7.34
3	197	0.05	950	50	17.71
4	197	0.05	950	50	17.72
5	197	0.05	950	50	17.73
6	197	0.05	950	50	17.81
7	197	0.05	950	50	17.82
8	197	0.05	950	50	17.83
9	197	0.05	950	50	17.91
10	197	0.05	950	50	17.92
11	100	0.04	1200	50	18.38
12	100	0.04	1200	50	18.39
13	100	0.04	1200	50	18.48
14	76	0.02	1960	40	19.34
15	76	0.02	1960	40	19.35
16	76	0.02	1960	40	19.36
17	76	0.02	1960	40	19.45
18	76	0.02	1960	40	19.46
19	155	0.04	960	40	24.53
20	155	0.04	960	40	24.54
21	155	0.04	960	40	24.61
22	155	0.04	960	40	24.62
23	155	0.04	960	40	24.63
24	155	0.04	960	40	24.64
25	155	0.04	960	40	24.71
26	155	0.04	960	40	24.72
27	20	0.1	450	50	29.27
28	20	0.1	450	50	29.28
29	20	0.1	450	50	29.29
30	20	0.1	450	50	29.30
31	50	0.01	1980	20	29.38
32	20	0.1	450	50	29.38
33	20	0.1	450	50	29.39
34	50	0.01	1980	20	29.45
35	50	0.01	1980	20	29.46
36	20	0.1	450	50	29.47
37	50	0.01	1980	20	29.48
38	20	0.1	450	50	29.48
39	20	0.1	450	50	29.49
40	20	0.1	450	50	29.50
41	50	0.01	1980	20	29.54
42	50	0.01	1980	20	29.55
43	50	0.01	1980	20	29.56
44	12	0.02	2940	60	30.15
45	12	0.02	2940	60	30.16
46	12	0.02	2940	60	30.24
47	12	0.02	2940	60	30.36
48	12	0.02	2940	60	30.36
49	12	0.02	2940	60	30.37

Table 4.5: Comparison of the approximation of CVaR (5%) of the cost for the constrained and unconstrained set of the generators

	24 Hours	168 Hours	672 Hour	2016 Hours
Unconstrained generators set	$1.83 \times 10^7$	$7.55 \times 10^7$	$2.38 \times 10^8$	$6.33 \times 10^8$
Constrained generators set	$1.15 \times 10^7$	$5.71 \times 10^7$	$2.00 \times 10^8$	$5.64 \times 10^8$
Gap (%)	37.23	24.38	15.95	10.85

Table 4.5 compares the approximated CVaR of the cost for the sets form unconstrained and constrained UC problem. The gap is computed by

$$\text{Gap\%} = \frac{\text{Unconstr. approximated CVaR} - \text{Constr. approximated CVaR}}{\text{Unconstr. approximated CVaR}} \times 100.$$

The gap shows the impact of considering ramping and UC constraints on the CVaR of the cost. As the time horizon increases, the gap between the CVaR of the cost for the unconstrained set and constrained set decreases. It means that for longer horizon, unit commitment cost has less impact on the CVaR of the cost.

#### 4.4 Conclusions

This work presents an asymptotic approximation for CVaR of the production cost of a committed set of generators when outages occur. Generation cost in long term is shown to asymptotically follow a normal distribution [11]. In this study, we use this fact and also employ simplifying assumptions to use a renewal reward model to approximate the cost variance. Therefore, the formulation of CVaR for a normal distribution presented by [79] can be used as an approximation of CVaR of the total production cost when outages occur.

This approximation provides a fast computation of risk involved in the cost of a set of committed generators in the power system considering random outages. This method specifically, can be used as a tool to approximate the risk associated with the existing commitment in long term. Numerical exper-

iments and the comparison with simulation results shows the precision of the asymptotic approximation. We also show that as the time horizon increases, the impact of ignoring unit commitment and ramping constraints on approximation of the CVaR of the cost is less.

## CHAPTER 5. GENERAL CONCLUSION

The dissertation is a combination of three papers that address the consideration of risk in the unit commitment problem under supply and demand uncertainty. The topics include approaches to consider risk in unit commitment problem and methodologies to solve them.

Chapter 2 studies and compares two formulations based on two different approaches to deal with net load uncertainty in unit commitment problem; two-stage stochastic programming and robust optimization. A two-stage stochastic unit commitment problem is formulated with an objective function that includes CVaR of the dispatch costs. The robust optimization approach is considered with two different definition of uncertainty set. The first one, which is frequently used in the literature, is defined by a lower bound and an upper bound with a parameter controlling the deviation. We also applied another uncertainty set which is defined as a combination of historical scenarios.

The goal of this chapter is to study stochastic programming and robust optimization as the most widely used approaches in the unit commitment problem under net load uncertainty in order to compare the solutions and evaluate the effectiveness of these approaches. Numerical results show that stochastic programming formulation incorporating CVaR can achieve the most efficient combinations of cost and risk. Between the two uncertainty set formulations for robust optimization, the data-driven method results in better cost-risk trade-offs than the uncertainty set based on ranges.

In chapter 3, we enhanced the existing algorithm to solve robust optimization formulation by implementing a branch-and-cut algorithm. The drawback of the existing algorithm is that it requires the solution of a mixed-integer programming (MIP) problem in each iteration while this problem becomes larger during the course of the algorithm. As solving a MIP is computationally hard, this approach typically does not converge even for small sized problems and, hence, cannot be a good option for ISOs to deal with real-world problems.

The adopted branch-and-cut scheme overcomes this issue by solving only one single branch-and-bound tree and dynamically adding linear inequalities to eliminate infeasible solutions and refine the feasible region within that branch-and-bound. The proposed approach dramatically improves the solution time for RUC.

In chapter 4, we developed an asymptotic approximation to estimate CVaR of electric power production cost considering random outages of generating units. Considering simplifying assumptions, we apply a renewal reward process and definition of CVaR for normal distribution to achieve this approximation.

Most studies considering outages in the UC problem enumerate a given set of components as candidates for possible failures or consider all possible component failure scenarios which requires a lot of computational effort. Our approximation provides a fast computation for this situation. The numerical experiments and comparison with simulation results evaluate the precision of the asymptotic approximation for CVaR of the cost. The approximation gives more accurate solutions as it runs for a longer time horizon. This method can provide a tool to approximate the risk associated with generating unit failures given an existing commitment in long term operation.

Although the dissertation has reached its aims, there were some limitations which might be considered in future research. Chapter 2 focuses on stochastic programming and robust optimization. Other approaches of considering risk

such as chance constraints could be evaluated. Chapter 3 shows the efficiency of the proposed branch and cut method; however, this method could be evaluated by other test cases. It can also be implemented on alternative formulations of the UC which might be more efficient. In Chapter 4, ramping, minimum up and down-time, and transmission constraints are ignored. This simplification might affect the approximation results. The approximation could be extended to incorporate previously-decided commitments for each hour. In addition, it was assumed that no more than one generator can be failed at a time. However, considering more than one failure can be another future research topic.

## BIBLIOGRAPHY

- [1] 20% Wind Energy by 2030: Increasing the best Wind Energy's Contribution to U.S. Electricity Supply. <http://www.nrel.gov/docs/fy08osti/41869.pdf>.
- [2] California ISO. [www.caiso.com](http://www.caiso.com).
- [3] NREL Eastern Wind Dataset. [http://www.nrel.gov/electricity/transmission/eastern\\_wind\\_methodology.html](http://www.nrel.gov/electricity/transmission/eastern_wind_methodology.html).
- [4] Renewable Energy Analysis Laboratory, Department of Electrical Engineering, University of Washington. <http://www2.ee.washington.edu/research/real/library.html>.
- [5] An, Y. and Zeng, B. (2015). Exploring the modeling capacity of two-stage robust optimization: Variants of robust unit commitment model. *Power Systems, IEEE Transactions on*, 30(1):109–122.
- [6] Asensio, M. and Contreras, J. (2016). Stochastic unit commitment in isolated systems with renewable penetration under cvar assessment. *IEEE Transactions on Smart Grid*, 7(3):1356–1367.
- [7] Bertsimas, D. and Brown, D. B. (2009). Constructing uncertainty sets for robust linear optimization. *Operations Research*, 57:1483–1495.
- [8] Bertsimas, D., Litvinov, E., Sun, X. A., Zhao, J., and Zheng, T. (2013). Adoptive robust optimization for the security constrained unit commitment problem. *IEEE Transaction on Power Systems*, 28:52–63.



- [9] Bouffard, F., Galiana, F., and Conejo, A. (2005). Market-clearing with stochastic security-part i: formulation. *Power Systems, IEEE Transactions on*, 20(4):1818–1826.
- [10] Bouffard, F. and Galiana, F. D. (2004). An electricity market with a probabilistic spinning reserve criterion. *IEEE Transactions on Power Systems*, 19(1):300–307.
- [11] Brown, M. and Solomon, H. (1975). A second-order approximation for the variance of a renewal reward process. *Stochastic Processes and their Applications*, 3(3):301 – 314.
- [12] Bukhsh, W., Papakonstantinou, A., and Pinson, P. A robust optimisation approach using cvar for unit commitment in a market with probabilistic offers. <http://pierrepinson.com/docs/Bukhshetal2016.pdf>.
- [13] Carrion, M. and Arroyo, J. M. (2006). A computationally efficient mixed-integer linear formulation for the thermal unit commitment problem. *IEEE Transaction on Power Systems*, 21:1371–1378.
- [14] Chattopadhyay, D. and Baldick, R. (2002). Unit commitment with probabilistic reserve. In *Power Engineering Society Winter Meeting, 2002. IEEE*, volume 1, pages 280–285. IEEE.
- [15] Cheung, K., Gade, D., Silva-Monroy, C., Ryan, S. M., Watson, J.-P., Wets, R. J.-B., and Woodruff, D. L. (2015). Toward scalable stochastic unit commitment. part 2: Solver configuration and performance assessment. *Energy Systems*, 6(3):417–438.
- [16] Dai, C., Wu, L., and Wu, H. (2016). A multi-band uncertainty set based robust scuc with spatial and temporal budget constraints. *Power Systems, IEEE Transactions on*. doi:10.1109/TPWRS.2016.2525009.

- [17] Duran, M. A. and Grossmann, I. E. (1986). An outer-approximation algorithm for a class of mixed-integer nonlinear programs. *Mathematical Programming*, 36(3):307–339.
- [18] Dvorkin, Y., Pandzic, H., Ortega-Vazquez, M. A., and Kirschen, D. S. (2015). A hybrid stochastic/interval approach to transmission-constrained unit commitment. *Power Systems, IEEE Transactions on*, 30(2):621–631.
- [19] Feng, Y., Rios, I., Ryan, S. M., Spürkel, K., Watson, J.-P., Wets, R. J.-B., and Woodruff, D. L. (2015). Toward scalable stochastic unit commitment. part 1: load scenario generation. *Energy Systems*, 6(3):309–329.
- [20] Feng, Y. and Ryan, S. M. (2016). Solution sensitivity-based scenario reduction for stochastic unit commitment. *Computational Management Science*, 13(1):29–62.
- [21] Fletcher, R. and Leyffer, S. (1994). Solving mixed integer nonlinear programs by outer approximation. *Mathematical Programming*, 66(1):327–349.
- [22] Georgopoulou, C. A. and Giannakoglou, K. C. (2010). Metamodel-assisted evolutionary algorithms for the unit commitment problem with probabilistic outages. *Applied Energy*, 87(5):1782–1792.
- [23] Gourtani, A., Xu, H., Pozo, D., and Nguyen, T.-D. (2016). Robust unit commitment with n-1 security criteria. *Mathematical Methods of Operations Research*, 83(3):373–408.
- [24] Guan, Y. and Wang, J. (2014). Uncertainty sets for robust unit commitment. *Power Systems, IEEE Transactions on*, 29(3):1439–1440.
- [25] Hamzei, M. and Luedtke, J. (2014). Linearization-based algorithms for mixed-integer nonlinear programs with convex continuous relaxation. *Journal of Global Optimization*, 59:343–365.

- [26] Hedman, K. W., Ferris, M. C., O'Neill, R. P., Fisher, E. B., and Oren, S. S. (2010). Co-optimization of generation unit commitment and transmission switching with n-1 reliability. *IEEE Transactions on Power Systems*, 25(2):1052–1063.
- [27] Heitsch, H. and Rmisch, W. (2003). Scenario reduction algorithms in stochastic programming. *Computational Optimization and Applications*, 24(2-3):187–206.
- [28] Huang, Y., Zheng, Q. P., and Wang, J. (2014). Two-stage stochastic unit commitment model including non-generation resources with conditional value-at-risk constraints. *Electric Power Systems Research*, 116:427 – 438.
- [29] Jha, R., Ghose, T., Sedimbi, D., and Lalitha, E. (2008). Solution of unit commitment using modified genetic algorithm considering the effect of unit outage uncertainty. *International Journal of Power & Energy Systems*, 28(1):1–8.
- [30] Jiang, R., Wang, J., and Guan, Y. (2012). Robust unit commitment with wind power and pumped storage hydro. *Power Systems, IEEE Transactions on*, 27(2):800–810.
- [31] Jiang, R., Wang, J., Zhang, M., and Guan, Y. (2013). Two-stage minimax regret robust unit commitment. *Power Systems, IEEE Transactions on*, 28(3):2271–2282.
- [32] Jiang, R., Zhang, M., Li, G., and Guan, Y. (2014). Two-stage network constrained robust unit commitment problem. *European Journal of Operational Research*, 234(3):751 – 762.
- [33] Lorca, A. and Sun, X. A. (2015). Adaptive robust optimization with dynamic uncertainty sets for multi-period economic dispatch under significant wind. *Power Systems, IEEE Transactions on*, 30(4):1702–1713.

- [34] Lorca, A., Sun, X. A., Litvinov, E., and Zheng, T. (2016). Multistage adaptive robust optimization for the unit commitment problem. *Operations Research*, 64(1):32–51.
- [35] Martinez, G. and Anderson, L. (2014). Toward a scalable chance-constrained formulation for unit commitment to manage high penetration of variable generation. In *Communication, Control, and Computing (Allerton), 2014 52nd Annual Allerton Conference on*, pages 723–730. IEEE.
- [36] Martinez, G. and Anderson, L. (2015). A risk-averse optimization model for unit commitment problems. In *2015 48th Hawaii International Conference*, pages 2577–2585. IEEE Computer Society.
- [37] Matos, M. and Bessa, R. (2011). Setting the operating reserve using probabilistic wind power forecasts. *Power Systems, IEEE Transactions on*, 26(2):594–603.
- [38] Morales, J., Conejo, A., and Perez-Ruiz, J. (2009). Economic valuation of reserves in power systems with high penetration of wind power. *Power Systems, IEEE Transactions on*, 24(2):900–910.
- [39] Morales-Espana, G., Latorre, J. M., and Ramos, A. (2013). Tight and compact MILP formulation for the thermal unit commitment problem. *Power Systems, IEEE Transactions on*, 28(4):4897–4908.
- [40] Morales-España, G., Latorre, J. M., and Ramos, A. (2013). Tight and compact milp formulation of start-up and shut-down ramping in unit commitment. *Power Systems, IEEE Transactions on*, 28(2):1288–1296.
- [41] Murillo-Snchez, C. E., Zimmerman, R. D., Anderson, C. L., and Thomas, R. J. (2013). A stochastic, contingency-based security-constrained optimal power flow for the procurement of energy and distributed reserve. *Decision Support Systems*, 56(0):1 – 10.

- [42] Naoum-Sawaya, J. and Elhedhli, S. (2013). An interior-point benders based branch-and-cut algorithm for mixed integer programs. *Annals of Operations Research*, 210(1):33–55.
- [43] Ozturk, U., Mazumdar, M., and Norman, B. (2004). A solution to the stochastic unit commitment problem using chance constrained programming. *Power Systems, IEEE Transactions on*, 19(3):1589–1598.
- [44] Pandzic, H., Dvorkin, Y., Qiu, T., Wang, Y., and Kirschen, D. S. (2016). Toward cost-efficient and reliable unit commitment under uncertainty. *IEEE Transactions on Power Systems*, 31(2):970–982.
- [45] Pandzic, H., Qiu, T., and Kirschen, D. S. (2013). Comparison of state-of-the-art transmission constrained unit commitment formulations. In *Power and Energy Society General Meeting (PES), 2013 IEEE*, pages 1–5. IEEE.
- [46] Peralta, J., Perez-Ruiz, J., and de la Torre, S. (2013). Unit commitment with load uncertainty by joint chance-constrained programming. In *PowerTech (POWERTECH), 2013 IEEE Grenoble*, pages 1–6.
- [47] Pozo, D. and Contreras, J. (2013). A chance-constrained unit commitment with an security criterion and significant wind generation. *IEEE Transactions on Power Systems*, 28(3):2842–2851.
- [48] Quan, H., Srinivasan, D., Khambadkone, A. M., and Khosravi, A. (2015). A computational framework for uncertainty integration in stochastic unit commitment with intermittent renewable energy sources. *Applied Energy*, 152:71–82.
- [49] Rei, W., Cordeau, J.-F., Gendreau, M., and Soriano, P. (2009). Accelerating benders decomposition by local branching. *INFORMS Journal on Computing*, 21(2):333–345.

- [50] Rockafellar, R. T. and Uryasev, S. (2002). Conditional value-at-risk for general loss distributions. *J. of Banking and Fincance*, 26:1443–1471.
- [51] Rockafellar, R. T. and Uryasev, S. (2006). Optimization of conditional value-at-risk. *J. Risk*, 2:21–41.
- [52] Ross, S. M. (2010). *Introduction to Probability Models*. 10th Edition. Academic Press.
- [53] Ruiz, P., Philbrick, C., and Sauer, P. (2010). Modeling approaches for computational cost reduction in stochastic unit commitment formulations. *Power Systems, IEEE Transactions on*, 25(1):588–589.
- [54] Ruiz, P., Philbrick, C., Zak, E., Cheung, K., and Sauer, P. (2009a). Uncertainty management in the unit commitment problem. *Power Systems, IEEE Transactions on*, 24(2):642–651.
- [55] Ruiz, P. A., Philbrick, C. R., Zak, E., Cheung, K. W., and Sauer, P. W. (2009b). Uncertainty management in the unit commitment problem. *IEEE Transactions on Power Systems*, 24(2):642–651.
- [56] Ryan, S. (1997). A renewal reward approximation for the variance of electric power production costs. *IIE Transactions*, 29(6):435–440.
- [57] Saharidis, G. K. and Ierapetritou, M. G. (2009). Resolution method for mixed integer bi-level linear problems based on decomposition technique. *Journal of Global Optimization*, 44(1):29–51.
- [58] Saharidis, G. K. and Ierapetritou, M. G. (2010). Improving benders decomposition using maximum feasible subsystem (mfs) cut generation strategy. *Computers & chemical engineering*, 34(8):1237–1245.
- [59] Smith, W. L. (1955). Regenerative stochastic processes. In *Proceedings of the Royal Society of London A: Mathematical, Physical and Engineering Sciences*, volume 232, pages 6–31. The Royal Society.

- [60] Street, A., Oliveira, F., and Arroyo, J. M. (2011). Contingency-constrained unit commitment with security criterion: A robust optimization approach. *IEEE Transactions on Power Systems*, 26(3):1581–1590.
- [61] Sun, X. and Fang, C. (2010). Interval mixed-integer programming for daily unit commitment and dispatch incorporating wind power. In *Power System Technology (POWERCON), 2010 International Conference on*, pages 1–6.
- [62] Tahanan, M., van Ackooij, W., Frangioni, A., and Lacalandra, F. (2015). Large-scale unit commitment under uncertainty. *4OR*, 13(2):115–171.
- [63] Takriti, S., Birge, J., and Long, E. (1996). A stochastic model for the unit commitment problem. *Power Systems, IEEE Transactions on*, 11(3):1497–1508.
- [64] Tseng, C. L. (1996). *On Power System Generation Unit Commitment Problem*. PhD thesis, Univ. California, Berkeley, CA, USA.
- [65] van Ackooij, W. (2015). A comparison of four approaches from stochastic programming for large-scale unit-commitment. *EURO Journal on Computational Optimization*, pages 1–29. doi:10.1007/s13675-015-0051-x.
- [66] Wang, J., Botterud, A., Bessa, R., Keko, H., Carvalho, L., Issicaba, D., Sumaili, J., and Miranda, V. (2011a). Wind power forecasting uncertainty and unit commitment. *Applied Energy*, 88(11):4014 – 4023.
- [67] Wang, J., Shahidehpour, M., and Li, Z. (2008). Security-constrained unit commitment with volatile wind power generation. *Power Systems, IEEE Transactions on*, 23(3):1319–1327.
- [68] Wang, J., Shahidehpour, M., and Li, Z. (2009). Contingency-constrained reserve requirements in joint energy and ancillary services auction. *Power Systems, IEEE Transactions on*, 24(3):1457–1468.

- [69] Wang, L. and Singh, C. (2009). Unit commitment considering generator outages through a mixed-integer particle swarm optimization algorithm. *Appl. Soft Comput.*, 9(3):947–953.
- [70] Wang, Q., Guan, Y., and Wang, J. (2012). A chance-constrained two-stage stochastic program for unit commitment with uncertain wind power output. *Power Systems, IEEE Transactions on*, 27(1):206–215.
- [71] Wang, Q., Wang, J., and Guan, Y. (2013a). Stochastic unit commitment with uncertain demand response. *IEEE Transactions on Power Systems*, 28(1):562–563.
- [72] Wang, Q., Watson, J.-P., and Guan, Y. (2013b). Two-stage robust optimization for n-k contingency-constrained unit commitment. *IEEE Transactions on Power Systems*, 28(3):2366–2375.
- [73] Wang, Y., Xia, Q., and Kang, C. (2011b). Unit commitment with volatile node injections by using interval optimization. *Power Systems, IEEE Transactions on*, 26(3):1705–1713.
- [74] Wong, P., Albrecht, P., Allan, R., Billinton, R., Chen, Q., Fong, C., Haddad, S., Li, W., Mukerji, R., Patton, D., Schneider, A., Shahidehpour, M., and Singh, C. (1999). The IEEE reliability test system-1996. a report prepared by the reliability test system task force of the application of probability methods subcommittee. *Power Systems, IEEE Transactions on*, 14(3):1010–1020.
- [75] Wood, A. and Wollenberg, B. (1996). *Power Generation, Operation, and Control*. A Wiley-Interscience publication. Wiley.
- [76] Wu, L., Shahidehpour, M., and Li, T. (2007). Stochastic security-constrained unit commitment. *Power Systems, IEEE Transactions on*, 22(2):800–811.



- [77] Wu, L., Shahidehpour, M., and Li, Z. (2012). Comparison of scenario-based and interval optimization approaches to stochastic scuc. *Power Systems, IEEE Transactions on*, 27(2):913–921.
- [78] Xiong, P., Jirutitijaroen, P., and Singh, C. (2016). A distributionally robust optimization model for unit commitment considering uncertain wind power generation. *IEEE Transactions on Power Systems*. doi:10.1109/TPWRS.2016.2544795.
- [79] Yamai, Y. and Yoshida, T. (2005). Value-at-risk versus expected shortfall: A practical perspective. *Journal of Banking & Finance*, 29(4):997–1015.
- [80] Zhang, Y., Shen, S., and Mathieu, J. (2016). Distributionally robust chance-constrained optimal power flow with uncertain renewables and uncertain reserves provided by loads. *IEEE Transactions on Power Systems*. doi:10.1109/TPWRS.2016.2572104.
- [81] Zhao, C. and Guan, Y. (2013). Unified stochastic and robust unit commitment. *IEEE Transaction on Power Systems*, 28:3353–3361.
- [82] Zhao, C. and Guan, Y. (2016). Data-driven stochastic unit commitment for integrating wind generation. *IEEE Transactions on Power Systems*, 31(4):2587–2596.
- [83] Zhao, L. and Zeng, B. (2012). Robust unit commitment problem with demand response and wind energy. In *Power and Energy Society General Meeting, 2012 IEEE*, pages 1–8.
- [84] Zheng, Q. P., Wang, J., and Liu, A. L. (2015). Stochastic optimization for unit commitment – a review. *Power Systems, IEEE Transactions on*, 30(4):1913–1924.